

# Technical Guidance Manual

Individual and Subsurface Sewage  
Disposal Systems



State of Idaho  
Department of Environmental Quality  
November 2020



Cover: Imogene Lake, Sawtooth Mountains, Idaho. Photo by Joe Canning.

This manual is updated periodically. For the most current version, see <http://www.deq.idaho.gov/water-quality/wastewater/septic-systems/technical-guidance-manual/>.

**Prepared by**  
Idaho Department of Environmental Quality  
Water Quality Division  
1410 N. Hilton  
Boise, ID 83706



*Printed on recycled paper, DEQ, December 2019, PID OSW6, CA code 82030. Costs associated with this publication are available from the State of Idaho Department of Environmental Quality in accordance with Section 60-202, Idaho Code.*

Controlled Document—Users are responsible for ensuring they work to the latest approved revision. Printed or electronically transmitted copies are uncontrolled.

## Table of Contents

Acronyms, Abbreviations, and Symbols .....	xvii
1 Introduction.....	1-1
1.1 Technical Guidance Committee .....	1-1
1.2 Individual and Subsurface Sewage Disposal Coordinator .....	1-1
1.3 Disclaimer.....	1-2
1.4 Product Approval.....	1-2
1.4.1 Director’s Policy on Product Approvals.....	1-2
1.4.2 Technical Guidance Committee Product Approval Policies .....	1-3
1.5 Installer’s Registration Permit and Service Provider Certification .....	1-10
1.5.1 Installer’s Registration Permit and Service Provider Certification Application, Bond, Fee, Training, and Exam.....	1-10
1.5.2 Permits and Certifications Required Annually .....	1-11
1.5.3 Service Provider Responsibilities .....	1-12
1.5.4 Installer’s Registration Permit Exemption.....	1-13
1.5.5 Installer’s Registration Permit or Service Provider Certification Revocation.....	1-13
1.6 Service Provider .....	1-14
Extended Treatment Package System Operation, Maintenance, and Monitoring .....	1-14
1.7 Existing and Approved Systems, Abandoned and Undocumented Systems, and Nonconforming Systems.....	1-15
1.7.1 Existing Systems.....	1-15
1.7.2 Approved Systems .....	1-15
1.7.3 Abandoned Systems.....	1-15
1.7.4 Undocumented Systems.....	1-16
1.7.5 Nonconforming Systems .....	1-16
1.8 Easement.....	1-18
1.8.1 Properties under Common Ownership.....	1-18
1.8.2 Properties under Separate Ownership.....	1-18
1.8.3 Property Access & Use Restrictions.....	1-20
1. If agreements for access for drainfields result in more than 2,500 GPD of effluent being disposed of on the same property, the drainfields must be designed as a large soil absorption system and undergo a nutrient-pathogen (NP) evaluation. ...	1-20
2. Access area boundaries that are not adjacent to the applicant’s property line must meet the separation distance of 5 feet between the drainfield and/or septic tank and the access area boundary.....	1-20
1.8.4 Loss of Access .....	1-20
1.9 Managed Operation, Maintenance, and Monitoring.....	1-21

1.9.1	Managed Operation and Maintenance .....	1-21
1.9.2	Managed Monitoring .....	1-22
1.9.3	Annual Reporting of Managed Operation, Maintenance, and Monitoring.....	1-27
1.9.4	Treatment System Failure, Disapproval, and Reinstatement.....	1-29
1.9.5	Property Owner Operation, Maintenance, or Monitoring Requirements .....	1-32
1.10	Service Provider Transition .....	1-34
1.10.1	Transition Sampling and Maintenance Requirements.....	1-34
1.10.2	Transition Enforcement Protocol.....	1-34
2	Soils and Ground Water.....	2-1
2.1	Soil Texture and Group Determinations.....	2-1
2.1.1	Determining Soil Textural Classifications.....	2-1
2.1.2	Soil Design Groups and Subgroups.....	2-6
2.1.3	Soil Design Subgroup Corrections .....	2-7
2.2	Separation Guidelines.....	2-9
2.2.1	Separation Distance Hierarchy .....	2-9
2.2.2	Effective Soil Depth to Porous Layers or Ground Water .....	2-9
2.2.3	Effective Soil Depths to Impermeable Layers.....	2-9
2.2.4	Effective Separation Distance to Surface Water .....	2-10
2.2.5	Method of 72 to Determine Effective Soil Depths .....	2-13
2.3	Evaluating Fill Material.....	2-17
2.3.1	Weathered Fill .....	2-17
2.3.2	Supplemental Irrigation .....	2-17
2.3.3	Fill Material Sites .....	2-17
2.3.4	Fill Material .....	2-18
2.3.5	Acceptable Fill Material .....	2-18
2.3.6	Mechanical Compaction Not Authorized .....	2-18
2.3.7	Site Preparation.....	2-18
2.3.8	Enhanced Weathering Procedures .....	2-19
2.4	Ground Water Level .....	2-22
2.4.1	Ground Water Monitoring.....	2-22
2.4.2	Monitoring Wells.....	2-22
2.4.3	Low Chroma Mottles.....	2-27
2.4.4	Historical Records .....	2-27
2.4.5	Low Water Years.....	2-28
2.5	Cutoff Trenches .....	2-29
2.5.1	Description.....	2-29
2.5.2	Purpose and Function .....	2-29
2.5.3	Approval Conditions.....	2-29

2.5.4	Design and Construction Techniques .....	2-34
2.5.5	Maintenance.....	2-35
2.6	Unstable Landforms .....	2-36
2.6.1	Description.....	2-36
2.6.2	Additional Application Information Requirement.....	2-37
3	Standard Subsurface Disposal System Design .....	3-1
3.1	Dimensional Requirements .....	3-1
3.2	Components of Standard Systems .....	3-4
3.2.1	Interceptors (Clarifiers) and Grease Traps .....	3-4
3.2.2	Building Sewer .....	3-5
3.2.3	Septic Tank and Dosing Chamber Installation .....	3-5
3.2.4	Drainfields .....	3-8
3.2.5	Equal Distribution.....	3-10
3.2.6	Serial Distribution.....	3-11
3.2.7	Drainfield Cover .....	3-14
3.2.8	Drainfield Excavation Backfilling Materials and Alternative System Construction Media .....	3-15
3.3	Wastewater Flows .....	3-19
3.3.1	Letter of Intended Use .....	3-19
3.3.2	Empirical Wastewater Flow Data.....	3-20
3.4	References .....	3-21
4	Alternative Systems .....	4-1
4.1	General Requirements .....	4-1
4.1.1	Engineering Requirements.....	4-2
4.1.2	Plumbing and Electrical Permits .....	4-3
4.1.3	Multiple Alternative Systems Combined into One System Design.....	4-4
4.2	At-Grade Soil Absorption System.....	4-8
4.2.1	Description.....	4-8
4.2.2	Approval Conditions.....	4-8
4.2.3	Design .....	4-9
4.2.4	Construction.....	4-15
4.2.5	Inspections .....	4-16
4.2.6	Operation and Maintenance.....	4-17
4.3	Capping Fill System .....	4-18
4.3.1	Description.....	4-18
4.3.2	Below-Grade Capping Fill System.....	4-18
4.3.3	Above-Grade Capping Fill System.....	4-19
4.3.4	Fill Material .....	4-20

4.3.5	Construction.....	4-20
4.3.6	Inspections.....	4-21
4.4	Composting Toilet.....	4-22
4.4.1	Description.....	4-22
4.4.2	Approval Conditions.....	4-22
4.4.3	Design Requirements.....	4-22
4.4.4	Compost Disposal.....	4-22
4.5	Drip Distribution System.....	4-24
4.5.1	Description.....	4-24
4.5.2	Approval Conditions.....	4-24
4.5.3	Design Requirements.....	4-25
4.5.4	Construction.....	4-29
4.5.5	Inspection.....	4-30
4.5.6	Operation and Maintenance.....	4-31
4.5.7	Suggested Design Example.....	4-31
4.6	Evapotranspiration and Evapotranspiration/Infiltrative Systems.....	4-36
4.6.1	Description.....	4-36
4.6.2	Approval Conditions.....	4-36
4.6.3	System Design Criteria.....	4-38
4.6.4	System-Sizing Procedure.....	4-39
4.6.5	Construction.....	4-42
4.6.6	Leak Testing.....	4-44
4.6.7	Operations and Maintenance Requirements.....	4-44
4.6.8	Additional System Considerations.....	4-45
4.6.9	Evapotranspiration System Calculation Example.....	4-45
4.7	Experimental System.....	4-51
4.7.1	Description.....	4-51
4.7.2	Approval Conditions.....	4-51
4.7.3	Design Requirements.....	4-51
4.7.4	Construction.....	4-52
4.7.5	Operation and Maintenance.....	4-52
4.8	Extended Treatment Package System.....	4-53
4.8.1	Description.....	4-53
4.8.2	Approval Conditions.....	4-53
4.8.3	ETPS Unit Design.....	4-54
4.8.4	Construction.....	4-55
4.9	Extra Drainrock Trench.....	4-57
4.9.1	Description.....	4-57

4.9.2	Approval Conditions.....	4-57
4.9.3	Calculations .....	4-59
4.10	Floating Vault Toilets and Boat or Vessel Sewage Disposal .....	4-63
4.10.1	Description.....	4-63
4.10.2	Approval Conditions.....	4-63
4.10.3	Floating Vault Toilet Design Requirements .....	4-64
4.10.4	Operation and Maintenance .....	4-65
4.11	Gravelless Trench System .....	4-67
4.11.1	Description.....	4-67
4.11.2	Approval Conditions.....	4-67
4.11.3	Design Requirements .....	4-67
4.11.4	Construction.....	4-68
4.12	Gray Water Sump .....	4-69
4.12.1	Description.....	4-69
4.12.2	Approval Conditions.....	4-69
4.12.3	Construction.....	4-69
4.13	Gray Water System.....	4-71
4.13.1	Description.....	4-71
4.13.2	Approval Conditions.....	4-71
4.13.3	Design Requirements.....	4-72
4.13.4	Other Requirements .....	4-74
4.14	Emergency Holding Tank.....	4-78
4.14.1	Description.....	4-78
4.14.2	Approval Conditions.....	4-78
4.14.3	Design Requirements.....	4-78
4.15	Individual Wastewater Incinerator .....	4-80
4.15.1	Description.....	4-80
4.15.2	Approval Conditions.....	4-80
4.15.3	Design Requirements .....	4-81
4.15.4	Operation and Maintenance .....	4-81
4.16	Individual Lagoon .....	4-82
4.16.1	Description.....	4-82
4.16.2	Approval Conditions.....	4-82
4.16.3	Design Requirements .....	4-82
4.16.4	Construction.....	4-84
4.16.5	Inspections .....	4-84
4.16.6	Operation and Maintenance .....	4-84
4.17	Pit Privy .....	4-86

4.17.1	Description.....	4-86
4.17.2	Approval Conditions.....	4-86
4.17.3	Pit Construction Requirements .....	4-86
4.17.4	Building Construction Requirements .....	4-86
4.17.5	Abandoning a Pit Privy.....	4-87
4.18	Portable Sanitation Units .....	4-88
4.18.1	Description.....	4-88
4.18.2	Approval Conditions.....	4-88
4.18.3	Units Required .....	4-88
4.18.4	Service Requirements .....	4-90
4.19	Pressure Distribution System .....	4-91
4.19.1	Description.....	4-91
4.19.2	Approval Conditions.....	4-91
4.19.3	Design Requirements .....	4-92
4.19.4	Inspections .....	4-105
4.19.5	Operation and Maintenance .....	4-106
4.20	Recreational Vehicle Dump Station .....	4-107
4.20.1	Description.....	4-107
4.20.2	Approval Conditions.....	4-107
4.20.3	Requirements .....	4-107
4.20.4	Recreational Vehicle Dump Station Waste Disposal .....	4-108
4.21	Recirculating Gravel Filter .....	4-109
4.21.1	Description.....	4-109
4.21.2	Approval Conditions.....	4-109
4.21.3	Design Requirements.....	4-110
4.21.4	Filter Construction .....	4-124
4.21.5	Drainfield Trenches .....	4-124
4.21.6	Inspection.....	4-125
4.21.7	Operation and Maintenance .....	4-125
4.22	Intermittent Sand Filter.....	4-127
4.22.1	Description.....	4-127
4.22.2	Approval Conditions.....	4-127
4.22.3	Design Requirements.....	4-127
4.22.4	Drainfield Trenches .....	4-131
4.22.5	Inspection.....	4-132
4.22.6	Operation and Maintenance .....	4-132
4.23	In-Trench Sand Filter .....	4-134
4.23.1	Description.....	4-134



4.23.2 Approval Conditions.....	4-134
4.23.3 Design and Construction Requirements .....	4-135
4.24 Sand Mound.....	4-140
4.24.1 Description.....	4-140
4.24.2 Approval Conditions.....	4-140
4.24.3 Design Requirements.....	4-141
4.24.4 Construction.....	4-147
4.24.5 Inspections .....	4-149
4.24.6 Operation and Maintenance .....	4-149
4.25 Seepage Pit/Bed.....	4-151
4.25.1 Description.....	4-151
4.25.2 Approval Conditions.....	4-151
4.25.3 Sizing .....	4-151
4.25.4 Construction.....	4-152
4.26 Steep Slope System .....	4-154
4.26.1 Description.....	4-154
4.26.2 Approval Conditions.....	4-154
4.26.3 Construction.....	4-154
4.27 Subsurface Flow Constructed Wetland .....	4-156
4.27.1 Description.....	4-156
4.27.2 Approval Conditions.....	4-156
4.27.3 Design Requirements.....	4-156
4.27.4 Submerged Flow Constructed Wetlands Construction.....	4-167
4.27.5 Drainfield Trenches .....	4-168
4.27.6 Inspection.....	4-168
4.27.7 Operation and Maintenance .....	4-169
4.28 Two-Cell Infiltrative System.....	4-171
4.28.1 Description.....	4-171
4.28.2 Approval Conditions.....	4-171
4.28.3 Design Requirements.....	4-171
4.28.4 Construction.....	4-172
4.28.5 Inspection.....	4-172
4.28.6 Operation and Maintenance .....	4-172
4.29 Vault Privy.....	4-174
4.29.1 Description.....	4-174
4.29.2 Approval Conditions.....	4-174
4.29.3 Design Requirements.....	4-174
4.30 Drainfield Remediation Components .....	4-176

4.30.1	Description.....	4-176
4.30.2	Approval Conditions.....	4-176
4.30.3	Construction.....	4-177
4.30.4	Operation .....	4-177
4.31	References .....	4-178
5	Approved Installers, Pumpers, and Components.....	5-1
5.1	Approved Installers and Pumpers.....	5-1
5.2	Approved Septic Tanks .....	5-2
5.3	Approved Dosing Chambers .....	5-12
5.4	Extended Treatment Package Systems.....	5-13
5.5	Approved Nondischarging Products.....	5-17
5.6	Gravelless Trench Components.....	5-20
5.7	Pump Vaults .....	5-22
5.8	Septic Tank Effluent Filters.....	5-23
5.9	Pipe Materials for Specified Uses .....	5-25
5.10	Vault Toilets .....	5-26
5.11	Drainfield Remediation Components.....	5-27
5.12	Total Nitrogen Reduction Approvals .....	5-28
5.13	Proprietary Wastewater Treatment Products.....	5-29
6	Complaint Investigation and Enforcement .....	6-1
6.1	Open Sewage Complaint Investigation Protocol.....	6-1
7	Rules and Codes .....	7-1
7.1	Administrative Rules .....	7-1
7.2	Idaho Code.....	7-1

Appendix A. Glossary

Appendix B. Triangle and Flowchart for Soil Texture Determination

## List of Tables

Table 1-1.	Recommended field testing constituents for effluent quality indication.....	1-23
Table 1-2.	Standard methods required for the analysis of ETPS effluent in annual testing. ....	1-24
Table 2-1.	Sizes of mineral, soil, and rock fragments. ....	2-1
Table 2-2.	Soil textural characteristics. <sup>a</sup> .....	2-2
Table 2-3.	Soil textural proportions.....	2-3
Table 2-4.	Soil textural classification design groups.....	2-7
Table 2-5.	Minimum effective soil depth (feet) by soil design subgroup to the limiting layer. ...	2-9
Table 2-6.	Effective soil depth (feet) to impermeable layers.....	2-10
Table 2-7.	Criteria for reducing separation distances to permanent or intermittent surface water. ....	2-11

Table 2-8. Treatment units assigned to each soil design subgroup per foot and per inch. .... 2-14

Table 2-9. Natural settling of fill over a 10-year period. .... 2-17

Table 2-10. Determination of seasonal ground water levels where the seasonal high ground water level and normal high ground water level occur within the same 6-week block of time. .... 2-26

Table 2-11. Determination of seasonal ground water levels where the seasonal high ground water level occurs outside the 6-week block of time that determines the normal high ground water level. .... 2-27

Table 2-12. Setbacks of drainfield from cutoff trench based on percent slope. .... 2-33

Table 2-13. Descriptions and characterizations of different unstable landforms. .... 2-36

Table 3-1. Constituent mass loadings and concentrations in typical residential wastewater.<sup>a</sup> .... 3-4

Table 3-2. Area requirements and total trench lengths for standard subsurface sewage disposal systems. .... 3-9

Table 3-3. Drainfield aggregate allowable particle size percent composition. .... 3-17

Table 3-4. Medium sand (modified ASTM C-33) allowable particle size percent composition. .... 3-17

Table 3-5. Pea gravel allowable particle size percent composition. .... 3-17

Table 3-6. Pit run allowable particle size percent composition. .... 3-18

Table 4-1. Matrix of compatible alternative systems that may be combined and used for a single system’s design. .... 4-6

Table 4-2. Maximum slope of natural ground. .... 4-9

Table 4-3. Linear loading rate ranges based on soil design subgroups. .... 4-10

Table 4-4. Downslope and upslope correction factors for soil cap width. .... 4-14

Table 4-5. Dual ring infiltrometer testing specifications. .... 4-38

Table 4-6. Water mass balance for an ET or ETI system. .... 4-39

Table 4-7. Sample water mass balance calculations for an ET system. .... 4-49

Table 4-8. Sample water mass balance calculation for ETI system. .... 4-50

Table 4-9. Multiplication factors to adjust drainfield length for extra drainrock. .... 4-60

Table 4-10. Gray water gravity flow mini-leachfield design criteria. .... 4-72

Table 4-11. Gray water flow by fixture type connected to system in gallons per person per day. .... 4-72

Table 4-12. Gray water application rates for landscape plants. .... 4-73

Table 4-13. Sodium and chloride tolerant plants. .... 4-74

Table 4-14. Portable units required per number of employees if the units are serviced once per week. .... 4-89

Table 4-15. Portable units required per number of employees if the units are serviced more than once per week. .... 4-89

Table 4-16. Portable unit requirements for number of people per event hours based on a 50/50 mix of men and women. .... 4-89

Table 4-17. Orifice discharge rate in gallons per minute based on pressure. .... 4-95

Table 4-18. Gallons per foot of pipe length. .... 4-99

Table 4-19. Recirculating gravel filter vertical separation to limiting layers (feet). .... 4-124

Table 4-20. Secondary biological treatment system hydraulic application rates. .... 4-125

Table 4-21. Intermittent sand filter vertical setback to limiting layers (feet). .... 4-131

Table 4-22. Secondary biological treatment system hydraulic application rates. .... 4-131

Table 4-23. Minimum depth of natural soil to limiting layer. .... 4-141

Table 4-24. Maximum slope of natural ground. .... 4-141

Table 4-25. Downslope correction factors for sloped sites..... 4-143

Table 4-26. Upslope correction factors for sloped sites. .... 4-143

Table 4-27. Example sand mound design checklist (use with Table 4-25, Table 4-26, Figure 4-44, and Figure 4-45). .... 4-145

Table 4-28. Sand mound design checklist (use with Table 4-25, Table 4-26, Figure 4-44, and Figure 4-45). .... 4-150

Table 4-29. Effective area of round seepage pits..... 4-152

Table 4-30. Subsurface flow constructed wetland sizing checklist. .... 4-162

Table 4-31. Required subsurface flow constructed wetland trains and cells based on daily design flow. .... 4-163

Table 4-32. Submerged flow constructed wetland vertical separation distance to limiting layers (feet). .... 4-168

Table 4-33. Secondary biological treatment system hydraulic application rates..... 4-168

Table 5-1. Approved septic tanks. .... 5-2

Table 5-2. Dosing chambers approved for use by DEQ. .... 5-12

Table 5-3. Extended treatment package systems approved by DEQ for provisional use. .... 5-13

Table 5-4. Extended treatment package systems approved by DEQ for general use. .... 5-16

Table 5-5. Composting toilets..... 5-17

Table 5-6. Individual wastewater incinerators..... 5-18

Table 5-7. Vault toilets. .... 5-19

Table 5-8. Other nondischarging products..... 5-19

Table 5-9. Gravelless trench components. .... 5-20

Table 5-10. Trench and product width-to-rating correlation. .... 5-21

Table 5-11. Septic tank pump vaults certified by DEQ..... 5-22

Table 5-12. Septic tank effluent filters certified by DEQ..... 5-23

Table 5-13. Pipe materials for specified uses. .... 5-25

Table 5-14. Vault toilets. .... 5-26

Table 5-15. Drainfield remediation components. .... 5-27

Table 5-16. On-site wastewater systems approved for total nitrogen reduction..... 5-28

Table 5-17. Proprietary wastewater treatment products. .... 5-29

**List of Figures**

Figure 1-1. Individual treatment system sampling process. .... 1-26

Figure 1-2. Failing wastewater treatment system enforcement flowchart. .... 1-31

Figure 2-1. United States Department of Agriculture soil textural triangle. .... 2-4

Figure 2-2. Soil texture determination flowchart..... 2-5

Figure 2-3. Test hole profile used in example 1. .... 2-14

Figure 2-4. Test hole profile used in example 2. .... 2-15

Figure 2-5. Permanent shallow ground water monitoring well design..... 2-23

Figure 2-6. Temporary ground water monitoring well design..... 2-24

Figure 2-7. Cutoff trench side view. .... 2-31

Figure 2-8. Cutoff trench plan view..... 2-32

Figure 2-9. Cutoff trench outfall..... 2-34

Figure 2-10. Cross section of an unstable landform. .... 2-37

Figure 3-1. Horizontal separation distance requirements for a standard drainfield (IDAPA 58.01.03.008.02.d and 58.01.03.008.04). ..... 3-1

Figure 3-2. Horizontal separation distance requirements for a septic tank (IDAPA 58.01.03.007.17). ..... 3-2

Figure 3-3. Cross-sectional view of a standard drainfield and trench dimensional installation requirements. .... 3-3

Figure 3-4. Overhead view of equal distribution methods for level sites. .... 3-10

Figure 3-5. Overhead view of a distribution box layout on a sloped site. .... 3-11

Figure 3-6. Overhead view of a relief line system network. .... 3-12

Figure 3-7. Side view of relief line installation between trenches. .... 3-12

Figure 3-8. Drop box and sequential distribution details. .... 3-13

Figure 3-9. Overhead view of drop box installation using multiple trenches with sequential distribution. .... 3-14

Figure 4-1. Cross-sectional view of an at-grade soil absorption system. .... 4-8

Figure 4-2. Additive contour loading rate example. .... 4-11

Figure 4-3. Cross section of an at-grade soil absorption system on a slope. .... 4-13

Figure 4-4. At-grade soil absorption systems placed upslope and downslope from one another. 4-16

Figure 4-5. Cross-sectional view of a below-grade capping fill trench. .... 4-19

Figure 4-6. Cross-sectional view of an above-grade capping fill trench. .... 4-20

Figure 4-7. Overhead view of typical drip distribution system. .... 4-33

Figure 4-8. Overhead view of filter, valve, and meter assembly for a noncontinuous flush system. .... 4-34

Figure 4-9. Cross-sectional view of typical filter, valve, and meter assembly for a noncontinuous flush system. .... 4-34

Figure 4-10. Overhead view of continuous flush system filter and meter assembly. .... 4-35

Figure 4-11. Cross section of evapotranspiration system. .... 4-40

Figure 4-12. Two examples of properly constructed standpipes. .... 4-43

Figure 4-13. Sampling port example. .... 4-55

Figure 4-14. Sampling port and drainfield. .... 4-56

Figure 4-15. Cross section of standard trench with extra drainrock. .... 4-58

Figure 4-16. Cross section of an above-grade capping fill trench with extra drainrock. .... 4-59

Figure 4-17. Cross section of gray water sump system. .... 4-70

Figure 4-18. Gray water system (single-tank gravity). .... 4-76

Figure 4-19. Gray water system (single-tank pumped). .... 4-77

Figure 4-20. Dosing chamber with a pump and screen. .... 4-102

Figure 4-21. Dosing chamber with a pump vault unit. .... 4-103

Figure 4-22. Example of effluent pump installed into single-compartment septic tank using a pump vault unit. .... 4-104

Figure 4-23. Example of pump to drop box installation. .... 4-105

Figure 4-24. Recirculating tank in system design without nitrogen treatment requirements. . 4-111

Figure 4-25. Recirculating gravel filter. .... 4-113

Figure 4-26. Overhead view of a recirculating gravel filter with multiple cells and dosing zones discharging to a dosing chamber and using mechanical flow splitting. .... 4-114

Figure 4-27. Gravity float valve return location within the recirculating tank. .... 4-116

Figure 4-28. Bottom view of a mechanical flow splitter for gravity distribution that delivers wastewater to all transport pipes with each dose. .... 4-117

Figure 4-29. Overhead view of a mechanical flow splitter for pressure distribution that only delivers wastewater to one transport pipe with each dose..... 4-118

Figure 4-30. Cross section of a recirculating gravel filter system with pressure transport to, and/or within, the drainfield. .... 4-119

Figure 4-31. Cross section of a recirculating gravel filter system with gravity transport to the drainfield..... 4-120

Figure 4-32. Effluent return locations and ratios from the recirculating gravel filter and flow splitter for systems treating total nitrogen. .... 4-121

Figure 4-33. Cross section of a nitrogen-reducing recirculating gravel filter system with pressure transport to, and/or within the drainfield..... 4-122

Figure 4-34. Cross section of a nitrogen-reducing recirculating gravel filter system with gravity transport to the drainfield. .... 4-123

Figure 4-35. Cross section of flexible membrane intermittent sand filter cell. .... 4-130

Figure 4-36. Cross section of an intermittent sand filter system with gravity discharge to the drainfield..... 4-133

Figure 4-37. Cross section of an intermittent sand filter system with pressure transport to and/or distribution within the drainfield..... 4-133

Figure 4-38. In-trench sand filter accessing suitable soils through an unsuitable soil layer. .. 4-136

Figure 4-39. Standard enveloped in-trench sand filter for installation in coarse native soils (i.e., coarse or very coarse sand or gravel). .... 4-137

Figure 4-40. Enveloped in-trench sand filter with alternative pretreatment for installation in coarse native soils (i.e., coarse or very coarse sand or gravel). .... 4-138

Figure 4-41. Enveloped pressurized in-trench sand filter for installation in suitable soils for a reduction in separation distance to ground water. .... 4-139

Figure 4-42. Cross-sectional view of sand mound..... 4-140

Figure 4-43. Multiple absorption bed cells installed in one sand mound. .... 4-142

Figure 4-44. Design illustrations for sand mound installation on flat and sloped sites (use with sand mound design checklist)..... 4-143

Figure 4-45. Design dimensions for use with the sand mound design checklist. .... 4-144

Figure 4-46. Mounds placed upslope and downslope of one another..... 4-148

Figure 4-47. Illustration of a steep slope trench with an example of maximum and minimum slope..... 4-155

Figure 4-48. Cross-sectional view of a subsurface flow constructed wetland..... 4-156

Figure 4-49. Cross-sectional view of a constructed wetland cell. .... 4-158

Figure 4-50. Configuration of wetland cells in series and parallel. .... 4-163

Figure 4-51. Overhead view of a wetland showing the inlet and outlet control structures in relation to the wetland width. .... 4-165

Figure 4-52. Cross-sectional view of an overflow basin. .... 4-165

Figure 4-53. Vegetation and planting spacing throughout the wetland treatment zone. .... 4-167

Figure 4-54. Cross-sectional view of a two-cell infiltrative system. .... 4-173

Figure 4-55. Overhead view of a two-cell infiltrative system. .... 4-173

**List of Equations**

Equation 4-1. ET and ETI system horizontal area in square feet. .... 4-38

Equation 4-2. ET and ETI vertical effluent depth (feet)..... 4-40

Equation 4-3. Plant water efficiency adjustment ..... 4-41

Equation 4-4. ET and ETI system monthly storage depth (feet) ..... 4-41

Equation 4-5. ET system cumulative storage depth (feet) ..... 4-41

Equation 4-6. ET system saturated bed depth (feet) ..... 4-42

Equation 4-7. Monthly precipitation contribution (Table 4-6, column A). ..... 4-46

Equation 4-8. Cumulative storage (Table 4-6, column E)..... 4-48

Equation 4-9. Saturated bed depth (Table 4-6, column F)..... 4-48

Equation 4-10. Multiplication factor..... 4-60

Equation 4-11. Landscaped area needed for gray water produced. .... 4-73

Equation 4-12. Gallons per week needed for irrigated plants..... 4-74

Equation 4-13. Lagoon horizontal area (square feet)..... 4-83

Equation 4-14. Total head..... 4-97

Equation 4-15. Effluent application area. .... 4-143

Equation 4-16. Percent slope of a site..... 4-155

Equation 4-17. BOD and TSS surface area in square feet..... 4-158

Equation 4-18. Darcy’s Law ..... 4-159

Equation 4-19. Initial treatment zone length..... 4-160

Equation 4-20. Final treatment zone length..... 4-160

Equation 4-21. Hydraulic retention time. .... 4-161

Equation 4-22. Length-to-width ratio of the subsurface flow constructed wetland. .... 4-161

*This page intentionally left blank for correct double-sided printing.*



## Acronyms, Abbreviations, and Symbols

<, ≤, >, ≥	less than, less than or equal to, greater than, greater than or equal to
ABS	acrylonitrile-butadiene-styrene
AR	aspect ratio
ACI	American Concrete Institute
ANSI	American National Standards Institute
ASTM	An international organization, originally known as the American Society for Testing and Materials, that sets voluntary standards for technical products, materials, systems, and services.
BOD	biological oxygen demand
CAP	corrective action plan
CBOD <sub>5</sub>	5-day carbonaceous biochemical oxygen demand
CFR	Code of Federal Regulations
cm	Centimeter
cm/s	centimeters per second
COD	chemical oxygen demand
C <sub>u</sub>	coefficient of uniformity
DEQ	Idaho Department of Environmental Quality
DRC	drainfield remediation components
EHS	environmental health specialist
EPA	United States Environmental Protection Agency
ET/ETI	evapotranspiration/evapotranspiration infiltrative
ETPS	extended treatment package system
ETr	evapotranspiration rate
Fe <sup>+++</sup>	ferric iron
ft <sup>2</sup>	square feet
ft <sup>3</sup>	cubic feet
GPD	gallons per day
GPM	gallons per minute
GPW	gallons per week
HDPE	high-density polyethylene
HRT	hydraulic residence time

IDAPA	Numbering designation for all administrative rules in Idaho promulgated in accordance with the Idaho Administrative Procedures act
mg/L	milligram per liter
mm	millimeter
MPC	monthly precipitation contribution
MSD	marine sanitation device
NFPA	National Fire Protection Association
NO <sub>2</sub> -N	nitrite-nitrogen
NO <sub>3</sub> -N	nitrate-nitrogen
NOV	notice of violation
NP	nutrient-pathogen (evaluation)
NSF	National Sanitary Foundation
O&M	operations and maintenance
OMM	operation, maintenance, and monitoring
PE	professional engineer
PF	peaking factor
PG	professional geologist
PLC	programmable logic controller
ppm	parts per million
psi	pounds per square inch
PVC	polyvinyl chloride
PWTP	proprietary wastewater treatment products
RV	recreational vehicle
TCIS	two-cell infiltrative system
TGM	Technical Guidance Manual Individual and Subsurface Sewage Disposal Systems
TKN	total Kjeldahl nitrogen
TN	total nitrogen
TSS	total suspended solids
UPC	Uniform Plumbing Code
USDA	United States Department of Agriculture

# 1 Introduction

To restore and maintain the quality of public waters and protect the public health and general welfare of Idaho's residents and visitors, the Board of Environmental Quality adopted the "Individual/Subsurface Sewage Disposal Rules" (IDAPA 58.01.03). Because of the dynamic and complex nature of small wastewater disposal systems governed by IDAPA 58.01.03, an ongoing technical guidance document is necessary. A Technical Guidance Committee (TGC) was mandated by the rule (IDAPA 58.01.03.004.07) to establish criteria for alternatives to standard drainfield systems. This Technical Guidance Manual (TGM) has been prepared to summarize the criteria and provide guidance to environmental health specialists, professional engineers, installers, homeowners, and others who need information on detailed design, construction, alteration, repair, and operation/maintenance of standard individual subsurface sewage disposal systems, components, and alternatives. Appendix A provides a glossary of terms.

## 1.1 Technical Guidance Committee

Revision: July 18, 2013

To provide the latest information for this manual, the TGC was established by the Board of Environmental Quality (IDAPA 58.01.03.004.07). The committee includes three environmental health specialists from Idaho health districts, a member of the Idaho Department of Environmental Quality (DEQ), a professional engineer (PE) licensed in Idaho, and a permitted septic system installer. The preferred composition of environmental health specialists provided by the Idaho health districts is an environmental health director, environmental health supervisor, and senior environmental health specialist. All appointments are for 3-year terms, except for the DEQ appointment, which shall be permanently held by DEQ's on-site wastewater coordinator or equivalent. All sections of the TGM have been reviewed and approved by the TGC prior to inclusion herein (IDAPA 58.01.03.004.08).

## 1.2 Individual and Subsurface Sewage Disposal Coordinator

Revision: July 18, 2013

DEQ provides an individual subsurface sewage disposal coordinator (on-site wastewater coordinator) to assist in updating and maintaining the TGM in a timely manner, advise the TGC on the latest state-of-the-art on-site subsurface disposal methodologies and products, track changes in laws, and provide approvals for new subsurface sewage disposal products and components, operation and maintenance (O&M) entities, and any other subsurface sewage disposal-related issue. The coordinator also provides continuing education and technical support to those involved in subsurface sewage disposal system design, approval, installation, operation and maintenance, as well as the general public. In addition, the coordinator will provide periodic subsurface program audits of Idaho's health districts for assistance in developing and ensuring statewide consistency in the individual subsurface sewage disposal program delivery.

## 1.3 Disclaimer

Revision: July 18, 2013

The inclusion of a new alternative system technology in this manual does not imply that such technology will be approved for use. The TGM is provided solely for guidance if a particular alternative's implementation is desired.

Product listings do not constitute endorsement. Products not listed may be approved by the Director (IDAPA 58.01.03.009) if, after review, the product(s) are found to meet the regulatory intent of IDAPA 58.01.03. Product approval shall follow the process outlined in section 1.4.

## 1.4 Product Approval

Revision: December 4, 2019

All commercially manufactured wastewater components must be approved by the Director prior to installation in a subsurface sewage disposal system (IDAPA 58.01.03.009.01). Plans, specifications, and any associated third-party data (e.g., National Sanitary Foundation [NSF]/American National Standards Institute [ANSI] standards and United States Environmental Protection Agency's [EPA] environmental technology verification testing) for commercially manufactured wastewater components must be submitted to DEQ's on-site wastewater coordinator for approval. The following plans and specifications are required to be submitted for product approval (IDAPA 58.01.03.009.02):

- Detailed construction drawings
- Capacities (i.e., volume and/or flow)
- Structural calculations
- List of product materials
- Evidence of stability and durability
- Manufacturer's installation requirements
- Operation and maintenance instructions
- Any other information deemed necessary by the Director

Product submissions should be made by the product's manufacturer or an associated distributor. Products may be disapproved if the product is not in compliance or may not consistently function in compliance with the IDAPA 58.01.03 rules (IDAPA 58.01.03.009.04). Manufacturers or distributors will be notified in writing of product approval or disapproval. If a product is approved, the Director reserves the right to specify circumstances under which the component must be installed, used, operated, or maintained (IDAPA 58.01.03.009.03). Products approved for installation in subsurface sewage disposal systems are found in section 5.

### 1.4.1 Director's Policy on Product Approvals

The Director's policy on product approvals dictates that all approvals for subsurface sewage disposal products must be recommended to DEQ by the TGC in accordance with their given duties (IDAPA 58.01.03.004.08) and in compliance with IDAPA 58.01.03. The TGC may

develop product approval policies that shall be included within this section of the TGM. The TGC may delegate product review and approval to DEQ for specific products.

## **1.4.2 Technical Guidance Committee Product Approval Policies**

Unless otherwise listed within this subsection of the TGM, all submissions for product approvals shall follow the process outlined in section 1.4.

### **1.4.2.1 Septic Tank Approvals**

All submissions for septic tank approvals shall be submitted to the DEQ on-site wastewater coordinator and reviewed by DEQ's Wastewater Program lead engineer. Approvals shall be issued by DEQ and do not need to undergo TGC review.

#### **1.4.2.1.1 Initial Septic Tank Approvals**

To obtain initial approval of a septic tank, a manufacturer must submit the following information for each individual septic tank model and variations of that model to DEQ. The documentation must be stamped, dated, and signed by a PE licensed in Idaho (IDAPA 58.01.03.009.02):

1. Detailed construction drawings, including the rebar or welded-wire mesh rigging details
2. Structural design plans, specifications, and calculations
3. Capacity calculations
4. List of construction materials
5. Manufacturer's installation and operation and maintenance instructions.

DEQ will review the septic tank submission and any other relevant information deemed necessary for approval. Minimum design standards considered suitable include the General Tank Specifications listed below and a maximum bury depth of 3 feet. If the tank is designed for a deeper bury depth, the engineering calculations must identify and incorporate the specified depth throughout the calculations.

#### ***General Tank Specifications***

1. The tank shall meet all of the design and construction standards described in IDAPA 58.01.03.007 (section 7.1).
2. The tank lid should be capable of supporting a minimum of 375 pounds per square foot.
3. Walls shall be designed to withstand an inside hydrostatic water pressure to the level of the outlet and for an outside earth pressure equivalent to the pressure exerted by a fluid weighing 62.4 pounds per cubic foot, according to accepted engineering practice. Alternatively, tanks may be designed to anticipated earth and hydrostatic pressures when the tank is either full or empty, if the load is anticipated to exceed the 62.4 pounds per cubic foot.
4. The tank shall be structurally designed to withstand all anticipated earth or other loads based on the specified bury depth.
5. The tank shall be capable of being filled with water for 24 hours without leaking or a major deflection in shape occurring.

6. The tank's inlet and outlet baffle system shall be included in the design and if constructed of pipe shall meet or exceed the rating of the American Society for Testing and Materials (ASTM) D3034.

### *Concrete Tank Specifications*

1. The walls and bottom slab shall be poured monolithically or be constructed with water stops if monolithic pours are not used in the tank construction.
2. Reinforcing steel shall be ASTM A615 Grade 60, yield strength ( $f_y$ ) = 60,000 pounds per square inch (psi).
  - a. Details and placement shall be in accordance with American Concrete Institute (ACI) 315 and ACI 318 or equivalent.
  - b. The certifying engineer shall be experienced in the use of structural reinforcement fibers if reinforced fibers are used.
3. Concrete shall be ready-mix with cement conforming to ASTM C1227-13.
  - a. The concrete shall have a cement content of not less than 5 sacks per cubic yard with a maximum aggregate size of 0.75 inches.
  - b. The water and cement ratio shall be kept low ( $0.45\pm$ ).
  - c. The concrete shall achieve a minimum compressive strength of 4,000 psi in 28 days.
4. The form release fluid used on the tank mold shall be compatible with the water-seal method used.
5. Tanks shall not be moved from the manufacturing site to a job site until the tank has cured for 7 days or has reached two-thirds of the design strength.

### *Plastic, Polyethylene, and Fiberglass Tanks*

1. The tank shall meet or exceed Canadian Standard CAN/CSA-B66-M90.
2. Verification of compliance with this standard shall be submitted through a report from an independent testing company certifying that the tank meets this standard.

### *Plan Submission*

1. After the septic tank plans and specifications are submitted for approval as described above, DEQ shall complete a review of those plans and specifications within 42 calendar days from the date of submittal.
2. If the plans and specifications are acceptable and complete, DEQ shall issue a preliminary approval letter to the manufacturer. This preliminary approval letter will specify the tank/model, volume, number of compartments, number of pieces, any special applications for the tank, and include any minor deficiencies that must be corrected before tank construction. This preliminary approval letter will also notify the manufacturer that a test tank must be constructed, and the test tank will be subjected to dimensional inspection and leak tested before receiving final approval from DEQ.

### *Construction and Leak Testing*

1. Upon preliminary approval, the manufacturer shall complete construction and leak testing either through a PE licensed in Idaho or an environmental health specialist (EHS) from one of Idaho's health districts.

2. The PE or EHS shall completely fill out DEQ's septic tank inspection form, available through the DEQ website, and submit the signed document to DEQ's on-site wastewater coordinator.
  - a. Before the manufacturer places the tank for the leak test, the PE or EHS shall inspect the dimensional elements of the tank listed on the inspection form, and note the date and time the tank is filled with water to the bottom of the tank's outlet.
  - b. Twenty-four hours after the tank is filled with water, the PE or EHS shall inspect the tank for the presence of any leaks and seeps, and note the difference in elevation of water in the tank.
  - c. Alternatively, a PE licensed in Idaho may witness a vacuum test, performed as specified in section 9.2.1 of ASTM C1227-13, in place of the water pressure leak test. The tank must be evacuated to 4 inches of mercury vacuum. To pass the leak test, the tank must retain at least 90% of this vacuum (3.6 inches of mercury) after 2 minutes.
3. If the construction and leak test documentation are consistent with the plans used for preliminary approval, DEQ will issue a final approval letter for the septic tank, place the septic tank on DEQ's approved septic tank list (section 5.2), and notify the manufacturer and health districts of the approval.

#### **1.4.2.1.2 Transfer of Septic Tank Approvals between Manufacturers**

If a manufacturer purchases or obtains another septic tank manufacturer's company and products, they must obtain approval for the other manufacturer's septic tank configurations from DEQ prior to any installation of the new septic tank models occurring. If the manufacturer or any of the septic tank models purchased are not listed on DEQ's approved septic tank list (section 5.2), the manufacturer seeking approval must submit the information listed in section 1.4.2.1.1 to obtain approval from DEQ. If the manufacturer and all of the septic tank models purchased are listed on DEQ's approved septic tank list (section 5.2), the purchasing manufacturer must submit the following information to DEQ to transfer the previous manufacturer's septic tank approvals:

1. A written and signed notification regarding the buyout of the manufacturer and the specific septic tank models that the purchasing manufacturer is seeking approval for. The written notification shall also include the following:
  - a. Information on which construction plans will be used for each septic tank model.
  - b. A statement regarding whether any of the purchased septic tank models will no longer be manufactured and that they may be removed from the approved septic tank list (section 5.2).
2. Upon receiving the notification, DEQ shall review the request and inform the manufacturer if the request is acceptable or if additional information is necessary.
  - a. If the request is acceptable, the manufacturer must have a PE or EHS complete the construction and leak test requirements listed in section 1.4.2.1.1, and the information must be submitted to DEQ for review.
  - b. If the construction and leak test information is acceptable, DEQ will issue a transfer approval for each septic tank model, place each septic tank model on DEQ's approved septic tank list (section 5.2) under the new manufacturer's name, remove the model from the purchased manufacturer, and notify the purchasing manufacturer and health districts of the transfer approval.

### **1.4.2.2 Extended Treatment Package System Approvals**

Extended treatment package systems (ETPS) are required to undergo two levels of approval in Idaho (IDAPA 58.01.03.009.03). The first level of approval is provisional approval based upon a manufacturer's submitted literature and data that support the treatment claims for the product. The second level of approval is general approval based upon a manufacturer's proven performance after installation and operation in Idaho. Upon receiving provisional approval, a manufacturer must proceed to obtain general approval within a specified timeframe otherwise the product will be disapproved.

#### **1.4.2.2.1 Provisional ETPS Approval**

Provisional ETPS approval allows a manufacturer's unit to be installed on a property, but the system must undergo annual operation, maintenance, monitoring, and reporting performed by an approved service provider and third-party tester. Operation, maintenance, monitoring, and reporting are the responsibility of the manufacturer under provisional approval.

Manufacturers seeking provisional approval of ETPS technology shall submit product information to DEQ's on-site wastewater coordinator for review by DEQ. In addition to product information (i.e., engineering designs and product manuals), manufacturers seeking approval on ETPS units for reducing total suspended solids (TSS) and carbonaceous biological oxygen demand (CBOD<sub>5</sub>) must submit NSF/ANSI Standard 40 approvals, reports, and associated data or equivalent third-party standards. Manufacturers also seeking approval on the ETPS units for reduction of total nitrogen (TN) must submit NSF Standard 245 approvals, reports, and associated data or equivalent third-party standards. Equivalency determinations of third-party standards shall be made by DEQ on a case-by-case basis. All third-party standards evaluated for the ETPS model must be submitted including approvals, disapprovals, reports, and associated data. ETPS units that have not undergone third-party testing and wish to be approved for reduction in TSS, CBOD<sub>5</sub>, and TN must be permitted and installed under the guidance in Section 4.7, "Experimental System."

As part of their request for provisional approval, manufacturer shall submit a quality assurance project plan to document how sampling and analysis will occur under provisional approval and identify who will perform both the sampling and analysis. All operation and maintenance performed during the provisional approval stage shall be done by a service provider approved by DEQ. All effluent testing performed during the provisional approval stage shall be done by a third-party contracted by the manufacturer with experience in wastewater sampling. The service provider and effluent tester may not be the same individual or work for the same company. The manufacturer seeking approval and third-party tester will be responsible for obtaining property access for testing of their system's effluent during the provisional approval stage. The manufacturer shall also be responsible for effluent testing costs.

All ETPS manufacturers that obtain provisional approval for one of their products must attempt to gain general approval and shall follow the minimum operation, maintenance, and effluent-testing procedures outlined in section 1.1. Upon receiving provisional approval for an ETPS model, a manufacturer must install that specific ETPS model within 2 years. If installation of the provisionally approved product does not occur within 2 years of the provisional approval, the ETPS model shall be disapproved (IDAPA 58.01.03.009.04). Once a manufacturer's ETPS



model is installed under provisional approval, operation, maintenance, and monitoring (OMM) of that unit as described in the manufacturer's quality assurance project plan and section 1.1 must begin that same reporting year unless the system was installed less than 3 weeks before the reporting deadline. Additionally, if OMM of the provisionally approved unit are not submitted to DEQ for any year after initial installation under provisional approval, the ETPS model shall be disapproved. Installed products under provisional approval that are disapproved shall be replaced by the manufacturer with a system that meets the installation requirements of the specific site where the ETPS model is installed.

ETPS with initial provisional approval effective July 1, 2016, must meet the requirements of section 1.4.2.2.2 for general approval by July 1, 2018, or may be considered a disapproved product.

#### **1.4.2.2.2 General ETPS Approval**

General ETPS approval allows a manufacturer's unit to be installed on a property without the requirement to sample effluent on an annual basis for systems that are not required to obtain a TN level less than 27 milligrams per liter (mg/L). The property owner must still have their ETPS unit undergo annual operation, maintenance, and reporting performed by an approved service provider.

To obtain general approval, or to lower reduction levels from those set in a general approval for any constituent, the ETPS model manufacturer must submit data from the ETPS models installed in Idaho. The data submitted must be obtained through OMM protocols described in section 1.4.2.2.1 under a DEQ-accepted quality assurance project plan. Data from other states will not be considered under this approval process. Any data submitted must be specific to a particular ETPS make and model. Data submission must include information on 30 installations with a minimum of 3 full years of operational data on each system, or the equivalent number of data points obtained on an annual basis for a lesser number of installations. All maintenance and effluent testing records, as described in section 1.1, obtained over this period must be submitted for review.

DEQ will issue general approval of an ETPS product in conjunction with associated reduction levels for TSS, CBOD<sub>5</sub>, and TN. TSS and CBOD<sub>5</sub> reduction levels will be set at less than or equal to 45 mg/L and 40 mg/L, respectively, based on the data showing that 90% of the installed units have successfully maintained effluent reduction levels at, or below, 45 mg/L TSS and 40 mg/L CBOD<sub>5</sub>. TN reduction levels will be determined through statistical analysis of the data submitted. The submitted data will be statistically evaluated to determine a resulting value that corresponds to a 95% upper confidence limit. The resulting value that corresponds to the 95% upper confidence limit will be used as the system's TN performance limit. Third-party report average reduction values will not be accepted to establish system performance approvals for any constituent.

For an adjustment in reduction levels of effluent constituents to be approved from a current general approval, a manufacturer must submit data that were obtained through a DEQ-accepted quality assurance project plan as described in section 1.4.2.2.1. Adjustments shall be made based on data analysis described in section 1.4.2.2.2 except that the data must be obtained over a period

of at least 2 years regardless of the number of data points and must be obtained for all of the specific ETPS models installed in Idaho for which the adjustment is being requested.

#### **1.4.2.2.3 Disapproved Extended Treatment Package Systems**

For those ETPS that were previously permitted and installed but are no longer on the approved ETPS product list, property owners are still responsible to have an approved service provider maintain these systems according to section 4.8.2. Annual reports verifying proper maintenance and operations of the system must be submitted according to section 1.9.3. Since disapproved systems in Idaho may no longer be supported by the manufacturer, the requirement for the service provider to be endorsed by the manufacturer is waived.

Owners of disapproved ETPS units that are no longer on the approved ETPS product list who fail to have their units maintained by an approved service provider and/or fail to submit an annual report may be considered failed and subject to enforcement action.

#### **1.4.2.3 Gravelless System Product Approvals**

Manufacturers seeking approval of a gravelless system product (e.g., chamber or synthetic media) as an alternative to drainfield aggregate shall submit product information to the DEQ on-site wastewater coordinator for review by DEQ and TGC. In addition to product information described in section 1.4, manufacturers must submit NSF/ANSI Standard 240 approvals, reports, and associated data. Any additional third-party standards evaluated for the gravelless system product must also be submitted including approvals, disapprovals, reports, and associated data.

DEQ will issue gravelless system product approval with associated sizing reduction allowances. Sizing reductions will be determined by analyzing the open trench bottom area, associated sidewall area, and storage capacity in comparison to a standard trench. Each component will be analyzed independently and compared to a standard trench, taking into account NSF/ANSI Standard 240 data. Reductions provided may be allowed up to a maximum of 25%.

Approval of products that have not undergone NSF/ANSI Standard 240 will not be considered for sizing reductions.

#### **1.4.2.4 Proprietary Wastewater Treatment Product Approval Policy**

Proprietary wastewater treatment products (PWTP) for subsurface sewage disposal are produced by a manufacturer to provide secondary wastewater treatment. PWTPs shall be considered on a case-by-case basis by the TGC. The manufactured product must have treatment characteristics similar to single-pass or recirculating media filters to be classified as a proprietary wastewater treatment product. Products requiring mechanical components in excess of a single-pass or recirculating media filter or that may allow wastewater to pass through the system untreated by design will not be considered for proprietary approval.

PWTP manufacturers must obtain approval from DEQ before permitting and installation. To obtain approval, the manufacturer must submit the required information listed in section 1.4 of this manual to DEQ's on-site wastewater coordinator. To justify the product's effectiveness for wastewater treatment, the manufacturer must also submit the final evaluation report on the product from NSF International under the provisions of NSF/ANSI Standard 40 or another

equivalent third-party standard. The NSF/ANSI Standard 40 report is required to obtain the same drainfield sizing reduction and separation distance reduction to limiting layers for the product as intermittent sand or recirculating gravel filters. If the manufacturer wants to obtain approval for TN reduction, they must submit the final evaluation report on the product from NSF International under the provisions of NSF/ANSI Standard 245 or another equivalent third-party standard. The NSF/ANSI Standard 245 report is required to obtain the same TN reduction as the recirculating gravel filter. Equivalency of third-party standards will be made by DEQ on a case-by-case basis.

Approval of PWTPs must be recommended to DEQ by the TGC. Approval of a PWTP may be required to undergo the same two-level approval process as ETPSs (section 1.4.2.2) depending on the system design and effluent reduction approvals sought. Approval processes and minimum installation requirements for PWTPs shall be determined on a case-by-case basis by the TGC. PWTPs submitted for approval that have not been evaluated under NSF/ANSI Standard 40 and/or 245, or another equivalent third-party standard shall not be considered for reduction in drainfield disposal area or for separation reductions to limiting layers. All approved PWTPs shall be installed by a permitted complex installer. Approved PWTPs are listed in section 5.13.

PWTPs may also require periodic operation and maintenance. The O&M provider for all PWTPs shall be determined on a case-by-case basis by the TGC and may be a property owner or an approved service provider. If a PWTP is approved, permitted, and installed with a nitrogen reduction limit that exceeds the nitrogen reduction limit of a recirculating gravel filter, the O&M provider for the PWTP shall be an approved service provider, and the system shall follow the same operation, maintenance, monitoring, and reporting requirements as ETPSs. If a nitrogen reduction limit is approved for a PWTP, it shall be listed in section 5.13.

#### **1.4.2.5 All Other Product Approvals**

All other wastewater products intended for installation in a subsurface sewage disposal system shall follow the process outlined in section 1.4 of this manual. If a product has been evaluated and meets a standard developed by NSF/ANSI, the product may be reviewed and approved for use by DEQ without TGC recommendation. For products that have not undergone NSF testing and certification, the necessary materials as described in section 1.4 must be submitted to DEQ for review by the TGC for approval recommendation.

## 1.5 Installer's Registration Permit and Service Provider Certification

Revision: August 6, 2020

An installer is considered any person, corporation, or firm engaged in the business of excavation for, or the construction of, subsurface sewage disposal systems (IDAPA 58.01.03.003.19). A service provider is any person, corporation, or firm engaged in the business of providing OMM of complex alternative systems in Idaho as identified by the Director (IDAPA 58.01.03.003.30). Per IDAPA 58.01.03.006.01, every installer and service provider shall secure from the Director an installer's registration permit. Service providers must also obtain a service provider's certification. Two types of installer permits and one type of service provider certification are available. These permits and certifications may be obtained from any health district in the state and may be used for installing subsurface sewage disposal systems throughout the state regardless of the health district through which the registration permit/certification was obtained. Standard/basic installer's registration permit holders are limited in the type of subsurface sewage disposal systems that may be installed. Complex alternative installer's registration permit holders may install all systems that are allowed by the standard/basic registration permit and all of the following complex alternative systems:

- At-grade soil absorption system
- Drip distribution systems
- Evapotranspiration and evapotranspiration/infiltrative systems
- Experimental systems
- Extended treatment package systems
- Pressurized gray water systems
- Individual lagoons
- Pressure distribution or transport systems
- Recirculating gravel filters
- Intermittent sand filters
- Pretreated enveloped in-trench sand filters
- Pressurized in-trench sand filters
- Sand mound
- Subsurface flow constructed wetland
- Two-cell infiltrative systems
- Drainfield remediation components
- Large soil absorption systems

A service provider certification is required to perform operation, maintenance, or monitoring of Director-identified complex alternative systems.

### 1.5.1 Installer's Registration Permit and Service Provider Certification Application, Bond, Fee, Training, and Exam

To obtain an installer's registration permit or service provider certification, the prospective applicant shall complete the following:

1. Submit an installer registration permit application or a service provider certification application to one of the health districts (IDAPA 58.01.03.006.04).
2. Submit a bond to the health district in a form approved by DEQ and in the sum applicable to the permit type or certification sought as specified in IDAPA 58.01.03.006.05.
3. Pay the applicable permit or certification application fee as set by the individual health district's board of health (fees may vary from district to district based on program costs).
4. The applicant shall attend a scheduled installer training class or view the installer video prior to taking the required installer examination.
5. The applicant seeking certification as a service provider shall also provide documentation of manufacturer-specific training, as required by IDAPA 58.01.03.006.06.a.
6. Pass the installer and service provider examination administered by the health district with a score of 70% or higher (IDAPA 58.01.03.006.02).

### **1.5.2 Permits and Certifications Required Annually**

Installer registration permits and service provider certifications shall be renewed annually (IDAPA 58.01.03.006.03). To renew an installer registration permit or service provider certification, the following items must be completed:

1. The health district issuing the registration permit or service provider certification must receive items 1 through 3 as described in section 1.5.1. Note: If renewing service provider certification, item 5 in section 1.5.1 is also required.
  - a. A bond continuation form may be substituted in lieu of a new bond upon registration permit or certification renewal.
  - b. If the installer registration permit is to be upgraded from a basic/standard registration permit to a complex alternative system registration permit at the time of renewal, then the complex installer shall attend a complex class or video, and the complex installer examination shall also be taken.
2. The applicant must attend a refresher course at least every third year meeting the requirements as described in section 1.5.2.1. Note: Individuals holding both a complex installer registration permit and service provider certification shall attend one refresher course for the complex installer registration permit and another course for the service provider certification. Installer and service provider refresher courses are not interchangeable.

#### **1.5.2.1 Refresher Course Requirements**

Installer or service provider refresher (continuing education) courses must be attended every 3 years to renew an installer registration permit or service provider certification per IDAPA 58.01.03.006.03. All refresher courses used to fulfill the refresher course requirements for an installer's registration permit or service provider certification must be approved by DEQ. Refresher courses delivered by the health district or DEQ are approved courses. All other courses proposed to be held by non-DEQ or health district organizations to fulfill the refresher course requirements must submit an agenda and curriculum to DEQ's on-site wastewater coordinator for review prior to holding the course. Courses held to fulfill the refresher course requirements of IDAPA 58.01.03.006.03 must meet the following:

- Be based on the most recent version of IDAPA 58.01.03 and the TGM.
- Contain information on recent updates to the TGM as approved by the TGC.
- Not contain manufacturer specific information.
- Have an agenda capable of filling a minimum of a 4-hour course.

Refresher courses may also contain the following:

- Health district information specific to the subsurface sewage disposal program.
- Discussion on issues related to the subsurface sewage disposal program identified by the health districts that need to be addressed with the installers or service providers.
- Presentations by nonhealth district or DEQ personnel as long as the presentations are not manufacturer specific.
- Other information as approved by DEQ.

Sign-in sheets should be maintained for all courses and should be filled out at the start and near the end of the course. Upon completing the course, the course provider should provide the installer or service providers a certificate of completion that includes the course date, time attended, and course holder. Health districts should maintain a copy of the most current certificate in each installer's or service provider's file. For courses attended by an installer or service provider that are not held by the health district they are licensed through, it is the installer's or service provider's responsibility to provide the health district with a copy of their course completion certificate. If installers cannot attend a refresher course, they may meet the permit or certification issuance requirement by completing the process described in section 1.5.2.2.

### **1.5.2.2 Refresher Course Substitution**

If installers or service providers cannot attend an approved refresher course to renew their registration permit or certification, they may complete the following:

1. Schedule a time with the permitting health district to watch a health district-approved video that meets the requirements of section 1.5.2.1.
2. If installers or service providers cannot attend an in-person class for 3 consecutive years to renew their installer registration permit or service provider certification, installers and service providers must watch the video referred to above and retake the installer or certification exam that applies to the permit-type certification sought for renewal.

### **1.5.3 Service Provider Responsibilities**

All certified service providers, who provide operation, maintenance, or monitoring for Director-identified complex alternative system, is responsible for compliance with each of the rules relevant to those services. Additionally, each certified service provider shall complete the following:

1. Obtain documentation of the completed manufacturer-specific training of each manufactured and packaged treatment system for which the service provider intends to provide operation, maintenance, or monitoring. Proper documentation includes a certificate or letter of training completion provided by the manufacturer. If a system manufacturer is no longer in business, that manufacturer-specific training is not required.

2. Maintain a comprehensive list of real property owners who contracted with the certified service provider. The list shall include the current real property owner's name, service property address, real property owner's contact address, and subsurface sewage disposal permit number. This list shall be provided to the Director as part of the annual OMM reports for individual real property owners.
3. Submit all OMM records in the form of an annual report, by US Mail, for each individual real property owner with whom the service provider contracts to fulfill the real property owner's operation, maintenance, or monitoring responsibilities required through the real property owner's subsurface sewage disposal installation permit as allowed in IDAPA 58.01.03.005.14. The annual reports shall be provided to the Director by the time frame specified in section 1.9.3 for the specific complex alternative system for which operation, maintenance, or monitoring is required. Annual report submittals may include more than one individual real property owner.

#### **1.5.4 Installer's Registration Permit Exemption**

An installer's registration permit is not required for the following (IDAPA 58.01.03.006.06):

1. Any person, corporation, or firm constructing a central or municipal subsurface sewage disposal system if that person, corporation, or firm is a licensed public works contractor, is experienced in the type of system to be installed, and is under the direction of a PE licensed in Idaho.
2. Any property owner installing their own standard or basic alternative system.
  - a. Property owners installing a subsurface sewage disposal system on their property under the property owner exemption must perform all work related to the excavation and must help and supervise all aspects of construction for the system.
  - b. Commercial and industrial property owners and government entities are also allowed the exemption from an installer's registration permit for work performed on standard or basic alternative systems installed on land owned by the entity. The entity may utilize their staff and must own or rent the equipment to install the system.

The installer's registration permit exemption does not apply under the following scenarios:

1. The excavation and construction of the system are performed by an outside contractor or individual that is not the property owner.
2. The installer is installing a complex alternative system and is not a licensed public works contractor under the direction of a PE.

#### **1.5.5 Installer's Registration Permit or Service Provider Certification Revocation**

All permitted subsurface sewage disposal installers and service providers must comply with IDAPA 58.01.03.002.04. Failure to comply with these rules may result in the revocation of an installer's registration permit or service provider certification for the remainder of the current permit cycle. Permit or certification revocation may be initiated by any health district regardless of where an installer or service provider obtained their registration permit or certification.

## 1.6 Service Provider

Revision: December 7, 2017

A service provider is any person, corporation, or firm engaged in the business of providing OMM of the following specific complex alternative systems in Idaho (IDAPA 58.01.03.003.30):

Complex alternative systems requiring service providers for OMM:

- ETPS
- Recirculating gravel filters

### **Extended Treatment Package System Operation, Maintenance, and Monitoring**

Beginning July 1, 2017, real property owners served by an ETPS are no longer required to be members of a nonprofit operation and maintenance entity. To meet the OMM requirements of their ETPS, real property owners shall retain the services of a service provider approved by DEQ (IDAPA 58.01.03.006.10.b).

Real property owners with member agreements and easements recorded with their county as a condition of subsurface sewage disposal permit issuance, may seek to remove those recorded documents at their own expense.



## 1.7 Existing and Approved Systems, Abandoned and Undocumented Systems, and Nonconforming Systems

Revision: March 20, 2015

### 1.7.1 Existing Systems

An existing subsurface sewage disposal system is a system installed prior to January 1, 1973, which was not permitted or approved by a health district (IDAPA 58.01.03.003.11). Existing subsurface sewage disposal system rights allow a property owner to use, repair, or replace the system for its original use and daily wastewater flow. Subsurface sewage disposal permits for the repair or replacement of an existing system must meet the current requirements of IDAPA 58.01.03 and the TGM. If it is not possible to repair or replace the existing system in full compliance with IDAPA 58.01.03, the replacement system must meet as many requirements of IDAPA 58.01.03 as possible and meet the intent of the rules (IDAPA 58.01.03.004.01) for any requirements that will not be in full compliance with IDAPA 58.01.03.

Existing systems will be repaired or replaced to meet the current requirements of IDAPA 58.01.03. Some situations may not allow for the replacement to meet all of the requirements of IDAPA 58.01.03. In those nonconforming cases, there is no right to repair or replace an existing system with a system that does not meet the intent of the rules. Meeting the intent of IDAPA 58.01.03 may require that a property owner replace an existing system, upon the system's failure, with an alternative system. Some alternative systems may require engineering or electrical components depending on the site conditions and alternative system requirements necessary to meet the intent of IDAPA 58.01.03. Any repair or replacement of an existing system that will only meet the intent of the rules must be issued as a nonconforming permit as described in the DEQ memorandum "Failing Subsurface Sewage Disposal System," dated July 26, 1993, contained within the *Idaho Subsurface Sewage Disposal Standard Operating Procedures*. If the repair or replacement of an existing system is for a different use than originally permitted or for increased wastewater flows (system expansion), the permit must be in full compliance with IDAPA 58.01.03 and follow the DEQ-issued program directive "Permit Requirements for Increased Flows at Single Family Dwellings," dated April 15, 2010, contained within the *Idaho Subsurface Sewage Disposal Standard Operating Procedures*.

### 1.7.2 Approved Systems

An approved subsurface sewage disposal system is a system installed after January 1, 1973, which has been permitted, inspected, and approved by a health district (IDAPA 58.01.03.003.03). Approval is documented by the health district in the form of a signed final inspection document or a signed approval letter. Approved subsurface sewage disposal system rights are the same for use, repair, and replacement of a system as described in section 1.7.1 for existing systems.

### 1.7.3 Abandoned Systems

An abandoned system is defined by IDAPA 58.01.03.003.01. The termination of wastewater discharge to a subsurface sewage disposal system for more than 2 years is the time frame used to determine system abandonment. A health district's determination that a system is abandoned

revokes any existing or approved system rights for the system and property. Abandoned systems may be used for subsurface sewage disposal if the property owner can demonstrate the following:

- The system meets the current requirements of IDAPA 58.01.03 and the TGM.
- The system is not failing as defined by IDAPA 58.01.03.003.13.

If there is not a previous subsurface sewage disposal permit, system authorization, or approval issued for the abandoned system, the health district may permit the system, provide authorization, or approve the system prior to its use.

#### **1.7.4 Undocumented Systems**

An undocumented subsurface sewage disposal system is a system that was installed after January 1, 1973, without a valid installation permit and record of a signed final inspection document or signed approval letter. Undocumented systems not acted upon within 2 years of identification are considered existing systems. An undocumented system may be replaced with a new system that meets the requirements of IDAPA 58.01.03 and the TGM at any time, but the undocumented system must be abandoned once construction of the replacement system is completed unless the undocumented system is turned into an approved system. An undocumented and abandoned system may not be repaired, expanded, or placed into use unless it is first approved. To turn an undocumented system into an approved system, the property owner must complete the following:

- Submit a complete subsurface sewage disposal permit application and fee to the health district of jurisdiction.
- Have the system uncovered by a permitted installer or the property owner exposing the septic tank, effluent piping, and both ends of each drainfield trench.
- Excavate at least one test hole within 10 feet of the existing drainfield at the time the system is uncovered unless there is existing soil documentation for the property.
- Have the septic tank pumped by a permitted septic tank pumper so the health district can evaluate the tank for structural integrity and determination of the necessity of a leak test.
- Allow the health district to inspect the exposed subsurface sewage disposal system and test hole to verify the installation meets all requirements of IDAPA 58.01.03 and the TGM.

If the subsurface sewage disposal system is found to be in compliance with all the requirements of IDAPA 58.01.03 and the TGM, the health district will issue a subsurface sewage disposal permit for the system and provide the permit holder with written approval of the system in the form of a completed and signed final inspection document. If additional construction is required to bring the system into compliance with IDAPA 58.01.03 and the TGM, the health district will issue a subsurface sewage disposal permit for the necessary requirements. Written approval of the system will be provided once the permit requirements have been installed, inspected by the health district, and verified to meet the permit requirements.

#### **1.7.5 Nonconforming Systems**

If it is necessary to issue a nonconforming subsurface sewage disposal permit, the permit shall require that the system meet as much of IDAPA 58.01.03 as possible and the nonconforming

permit requirement must meet the current intent of the rules (IDAPA 58.01.03.004.01). This may require the installation of an alternative system to meet separation distances or effective soil depths to features of interest or concern as described in IDAPA 58.01.03.007.17 and IDAPA 58.01.03.008.02.c-d.

A nonconforming system is a system that does not fully comply with all of the requirements of IDAPA 58.01.03. Nonconforming systems are typically existing systems or older approved systems that were installed after changes to IDAPA 58.01.03. For property owners to retain their existing or approved system rights in a nonconforming system, the system cannot be considered abandoned as described in section 1.7.3. All nonconforming systems must be brought into compliance with the intent of IDAPA 58.01.03 upon the repair, replacement, or enlargement of the system (IDAPA 58.01.03.004). The intent of the rules is best met by fully complying with the current requirements of IDAPA 58.01.03 at the time of permit issuance (IDAPA 58.01.03.004.02).

Some existing or approved systems may be located on properties that are no longer capable of meeting the requirements of IDAPA 58.01.03 due to changes in the rule requirements over time. If the property owner has maintained their existing or approved system right for the use, repair, or replacement of the system, they have the right to obtain a nonconforming repair or replacement permit for their property. All nonconforming permits shall be issued as described in the DEQ memorandum “Failing Subsurface Sewage Disposal System,” dated July 26, 1993, contained within the *Idaho Subsurface Sewage Disposal Standard Operating Procedures*. Issuance of a nonconforming permit shall only be for the original use and wastewater flow for the structure located on the property and neighboring features of interest (e.g., wells and water lines) shall take priority in separation distance requirements.

When issuing a nonconforming repair or replacement permit, an emphasis shall be placed on meeting the intent of IDAPA 58.01.03.004.01.d, preserving the existing or potential beneficial uses of the waters of the state. This emphasis arises out of the direction of Idaho’s legislative bodies as stated in Idaho’s water quality policy (Idaho Code §39-3601) and policy on environmental protection (Idaho Code §39-102).

## 1.8 Easement

Revision: November 5, 2020

The “Individual/Subsurface Sewage Disposal Rules” (IDAPA 58.01.03) provide that every owner of real property is responsible for storing, treating, and disposing of wastewater generated on that property. This responsibility includes obtaining necessary permits and approvals for installing an individual subsurface sewage disposal system. Often the storage, treatment, and disposal of wastewater remain solely on the real property from which it was generated. However, sometimes other real property is needed for the storage, treatment, or disposal of that wastewater. In this case, an agreement for access (e.g., an easement) may be required as part of the permit application. A real property owner wishing to install an individual subsurface sewage disposal system must obtain a permit under IDAPA 58.01.03 and any other necessary approval for installing the system, including any authorization needed to install the system on other real property that does not contain the wastewater-generating structure. Consistent with this requirement, IDAPA 58.01.03.005.04.1 requires a permit applicant to include in the application copies of legal documents relating to access to the entire system and all system components. The permit applicant should consult with an attorney about what type of legal document (e.g., easement, access agreement) is most appropriate for securing long-term access to the entire system and ensuring access for future property owners in the event of a sale of either property.

### 1.8.1 Properties under Common Ownership

Properties under common ownership where the wastewater generating structure is located on a property separate from portions of the wastewater disposal system pose a unique challenge. The doctrine of merger prevents an individual or property owner from granting an easement to themselves. However, it is critical that that property owner adequately demonstrate that the wastewater generating structure will have access to the associated wastewater disposal system. In order to prevent such properties from inadvertently divesting the structure from the wastewater disposal system, if any portion of a system is proposed to be installed on a combination of two properties/parcels under common ownership at the time of permit issuance, the following will be required:

1. The installation permit will state that the system is installed on a combination of two properties/parcels, and state that the owner should notify the health district prior to the sale of either property.
2. Prior to a sale, the owner must ensure that the waste-generating property retains access to and use of the property where the wastewater is treated, stored or disposed of (e.g., the drainfield) and provide this documentation to the health district. It is recommended the owner/seller consult an attorney to determine the most appropriate legal document for ensuring this future access and use (e.g., an easement)

### 1.8.2 Properties under Separate Ownership

This section provides guidance regarding the circumstances when to permit a system when the system is located on two properties/parcels owned by different property owners. In that case, an easement or other legal document must be included in or with an application for such a system.

1. Allowing an owner to install a subsurface sewage disposal system on another person's property will be considered. However, this option should be considered only when other practical solutions for subsurface sewage disposal are not available on the property where the wastewater is generated. In addition, the entire site (i.e., the area for both the primary and replacement drainfield) must be reviewed by the health district, and all sites must meet all requirements of IDAPA 58.01.03.
2. The placement of an individual subsurface sewage disposal system on another person's property requires a valid legal agreement (e.g., an easement or access agreement) to be in place before subsurface sewage disposal permit issuance. Valid legal agreements (e.g., easements) are required anytime any portion of a subsurface sewage disposal system is proposed on another's property. If a legal agreement or easement is submitted, it is the applicant's responsibility to ensure that the document:
  - a. Is prepared by an attorney;
  - b. Contains a sufficient description of the access area (i.e., the area where the portion of the subsurface sewage disposal system is located on another's property) and of the applicant's property where the wastewater is generated;
  - c. Contains language ensuring that the property with the access area can be used for the applicant's system;
  - d. Contains language ensuring that the applicant, or subsequent owner of the applicant's property, has the ability to access the other property to make repairs or perform routine maintenance until the system is abandoned. The language must ensure that use and access is maintained when either property is sold or otherwise transferred;
  - e. Contains language that restricts the access area from uses that may have an adverse effect on the system functioning properly;
  - f. Includes a survey, including monumenting the corners of the entire access area, to supply an accurate legal description of the access area for both the primary and replacement drainfield areas and allows the health district to properly evaluate the site. The survey and monumenting of the access area must be performed by an Idaho-licensed professional land surveyor; and
  - g. If the document is an easement, it is recorded in the county with jurisdiction.

The applicant must submit the valid legal agreement described in 2.a-g to the health district along with the permit application. It is not the duty of the health district to determine the legal adequacy of the document, and the issuance of a permit does not in any way represent or warrant that access has been properly created. The document will be evaluated whether: it has been prepared by an attorney; it includes a survey described in 2.f, and if it is an easement, evidence that it has been recorded in the county with jurisdiction. If these criteria are met, the health district may issue the permit. It is the responsibility of the applicant for ensuring that the document is legally sufficient and satisfies the requirements in item 2 above.

### **1.8.3 Property Access & Use Restrictions**

1. If agreements for access for drainfields result in more than 2,500 GPD of effluent being disposed of on the same property, the drainfields must be designed as a large soil absorption system and undergo a nutrient-pathogen (NP) evaluation.
2. Access area boundaries that are not adjacent to the applicant's property line must meet the separation distance of 5 feet between the drainfield and/or septic tank and the access area boundary.

### **1.8.4 Loss of Access**

If for any reason access to any portion of the subsurface sewage disposal system is lost and the system can no longer receive blackwaste and wastewater, the system may be considered failing (IDAPA 58.01.03.003.13). The owner of the waste-generating property must establish a new easement or other legal agreement that grants access to the property where the wastewater is treated, stored or disposed of.

If no legal access agreement can be reached, the owner of the waste-generating property must obtain a permit to repair or replace the failing system (IDAPA 58.01.03.004.05).

In the event the failing system cannot be repaired or replaced in a way that meets the current rules and regulations, the health district may issue a nonconforming permit if it can be determined that the public's health is not at risk (IDAPA 58.01.03.008.12). Otherwise, once all other options have been exhausted, the waste-generating property may be denied a subsurface sewage disposal permit.

## 1.9 Managed Operation, Maintenance, and Monitoring

Revision: March 4, 2019

OMM may be required for any system specified by the Director. The Director may specify OMM as a condition of a product's design approval (IDAPA 58.01.03.009.03) or as a condition of issuing a subsurface sewage disposal permit (IDAPA 58.01.03.005.14) to ensure protection of public health and the environment. This section lists the Director-specified OMM requirements. Managed OMM is performed by a certified service provider (section 1.6).

### 1.9.1 Managed Operation and Maintenance

Operation and maintenance refers to direct access to a subsurface sewage disposal system to provide planned or reactive activities that are necessary to ensure efficiency, effectiveness, and sustainability of the system. Managed operation and maintenance is required for systems the Director has determined need professional oversight to ensure the systems operate according to the rules (IDAPA 58.01.03) and system-specific recommendations provided by the TGC (IDAPA 58.01.03.004.10). When managed operation and maintenance is specified for a system, the following requirements shall be met (IDAPA 58.01.03.005.14 and 58.01.03.009.03):

1. Maintenance shall be performed on the system as described in the manufacturer's or design engineer's O&M manual submitted under section 1.4, or the specific alternative system's guidance section.
  - a. Manufactured systems that are incorporated into an engineered design shall also follow the minimum O&M requirements set by the design engineer.
  - b. Additional maintenance not specified in an O&M manual may be required to ensure the system functions properly.
2. Records for each O&M visit shall be submitted through OnlineRME ([www.OnlineRME.com](http://www.OnlineRME.com)). Obtain a copy of the subsurface sewage disposal permit to select the appropriate system components for inspection to create the annual report form within OnlineRME. System components for a typical gravity system will have at least one septic tank and one drainfield; a pressure system will usually have a septic tank, pump tank, pump, panel, and drainfield. Select "Routine Inspection" type in OnlineRME to report an inspection of all the system components performed. A typical report will contain the following information for the Routine Inspection visit:
  - a. Date and time.
  - b. Observation for objectionable odors.
  - c. Observation for surfacing of effluent from the system or drainfield.
  - d. Notation as to whether the system was pumped since the last O&M visit including the portions of the system pumped, pumping date, and volume.
  - e. Sludge depth and scum layer thickness in the system's tanks and/or treatment unit.
  - f. If responding to an alarm event, provide the cause of the alarm and any maintenance necessary to address the alarm situation.
  - g. Field testing results for any system effluent quality indicators included in the system's approved sampling plan (if required) or as recommended in section 1.9.2(2).

- h. Record of any cleaning and lubrication.
- i. Notation of any adjustments to control settings or equipment.
- j. Test results for pumps, switches, alarms, and blowers.
- k. Notation of any equipment or component failures.
- l. Equipment or component replacement including the reason for replacement.
- m. Recommendations for future service or maintenance and the reason for the recommendations.
- n. Any maintenance occurring after the primary maintenance visit should only record and address the reason for the visit and the associated activities that occur.

### 1.9.2 Managed Monitoring

Monitoring refers to the requirement for effluent sampling and analysis of wastewater discharged from a treatment system prior to the effluent entering the drainfield. Managed monitoring is required for systems that the Director has determined need field verification of the system's performance to ensure effluent quality limits are being met. When managed monitoring is specified for a system, the following requirements shall be met (IDAPA 58.01.03.005.14 and 58.01.03.009.03):

1. Effluent quality shall be monitored annually.
2. Annual monitoring included in the annual report must occur within the reporting period (Figure 1-1).
3. Effluent monitoring may be done for a group of treatment systems from a common dosing chamber resulting in the sample from the common dosing chamber being applied to all of the associated systems if:
  - a. Operation and maintenance is performed on an annual basis with a frequency outlined in the manufacturer's O&M manual and documented as described in section 1.9.1 for each individual treatment system, and O&M records are submitted for each individual treatment system as described in section 1.9.3.
  - b. All of the treatment systems connected to the common dosing chamber are from the same manufacturer or are the same engineered alternative treatment system design.
    - 1) If there are multiple manufacturers' units or multiple engineered alternative treatment system designs connected to the common dosing chamber, then each system must be monitored individually.
    - 2) If there are multiple common dosing chambers discharging to a single drainfield, then each common dosing chamber must be monitored.
    - 3) If there are any individual manufacturers' units or engineered alternative treatment system designs discharging to the same system independently of a common dosing chamber, then those individual units must also be monitored.
  - c. If the effluent sample from the common dosing chamber does not meet any one of the required effluent constituent levels for the system, then each individual treatment system connected to the common dosing chamber must be sampled independently for the failing constituent to determine which individual systems do not meet the effluent monitoring requirements.



- 1) Individual systems that do not meet the effluent constituent levels upon individual sampling must follow the O&M and retesting requirements described in item 10 below.
  - 2) Individual systems that do meet the effluent constituent levels upon individual sampling do not need to continue with the O&M and retesting requirements.
4. DEQ recommends that before collecting effluent samples from a treatment system for laboratory analysis that effluent quality indicators be field tested as described in the system’s approved sampling plan. Recommendations included in this section are recommendations only and should be verified with the treatment technology manufacturer or design engineer as acceptable with their field sampling plan and as suitable effluent quality indicators. Field testing is recommended to include, but may not be limited to the following:
- a. Visual examination for wastewater color, odor, and effluent solids.
  - b. Constituents shown in Table 1-1.

**Table 1-1. Recommended field testing constituents for effluent quality indication.**

Constituent	Acceptable Range
pH	6 to 9
Dissolved oxygen	≥2 mg/L
Turbidity	≤40 NTU

Notes: milligram per liter (mg/L); nephelometric turbidity unit (NTU)

5. Monitoring samples provided to a laboratory will analytically quantify that the treatment system is operating in compliance if samples do not exceed:
  - a. 40 mg/L (40 parts per million [ppm]) for CBOD<sub>5</sub>
  - b. 45 mg/L (45 ppm) for TSS
  - c. Permit-specific levels stipulated on the installation permit for nitrogen as described in item 6.
  - d. Permit-specific levels stipulated on the installation permit for other constituents of concern that may be determined on a case-by-case basis.
  - e. Effluent specific constituents that must be monitored for a treatment system may be specified in the treatment system-specific guidance in section 4 or determined on a case-by-case basis.
6. For those systems installed in areas of concern, including nitrogen sensitive areas, or are used to fulfill NP evaluation results and requirements, the following total nitrogen related constituents may be monitored to determine total nitrogen concentration:
  - a. Total Kjeldahl nitrogen (TKN)
  - b. Nitrate-nitrite nitrogen (NO<sub>3</sub>+NO<sub>2</sub>-N)
  - c. Results for total nitrogen (TN = TKN + [NO<sub>3</sub>+NO<sub>2</sub>-N])
7. Results for monitoring samples that exceed the stipulated levels on the installation permit indicate the treatment system is not achieving the required reduction levels.

8. Monitoring samples will be collected, stored, transported, and analyzed according to the latest version of *Standard Methods for the Examination of Water and Wastewater* (Rice et al. 2012) and other acceptable procedures:
  - a. Each sample will have a chain-of-custody form, identifying, at a minimum, the sample's source (street address or installation permit number), date and time of collection, and the person who extracted the sample.
  - b. Chain-of-custody form should also specify the laboratory analyses to be performed on the sample.
  - c. Sample storage and transport will take place in appropriate containers under appropriate temperature control.
9. Sample analysis will be performed by a laboratory capable of analyzing wastewater according to the acceptable standards identified in Table 1-2, and the monitoring results will be submitted as part of the annual report to the local health district.
  - a. Effluent analysis shall be performed using the standards in Table 1-2 from the *Standard Methods for the Examination of Water and Wastewater* (Rice et al. 2012) or the equivalent standards from EPA.
  - b. Annual reports submitted with laboratory analysis results differing from these standard methods will be rejected.

**Table 1-2. Standard methods required for the analysis of ETPS effluent in annual testing.**

Analysis	Standard Method Number	EPA Method Equivalent to Standard Method
Total suspended solids (TSS)	SM 2540 D	—
Carbonaceous biological oxygen demand (CBOD <sub>5</sub> ) <sup>a</sup>	SM 5210 B	—
Total Kjeldahl nitrogen (TKN)	SM 4500-Norg B	351.2
Nitrate-nitrite nitrogen (NO <sub>3</sub> + NO <sub>2</sub> -N)	SM 4500-NO <sub>3</sub> <sup>-</sup> F nitrate	353.2

a. Person requesting the analysis from the laboratory must specify the CBOD<sub>5</sub> on the chain-of-custody form.

- 10 Treatment systems failing to achieve the required effluent constituent levels shall require the following:
  - a. Additional operation and maintenance within 15 days of the failed sample results as determined by the date provided on the laboratory form.
 

If additional operation and maintenance or component replacement is necessary as determined from this service, then the reason, maintenance necessary, and dates must be provided as part of the service record.
  - b. Additional sampling to demonstrate the operation and maintenance performed successfully restored the treatment system to proper operation.
  - c. Sample extraction and analysis must occur within 30 days after servicing the system (as determined in item 10.a above).
 

The 30-day time frame for sample extraction will begin based on the last documented O&M visit required under item 10.a above.
  - d. A maximum of three sampling events, within 90 days (as determined from the last documented O&M visit from item 10.a above), will be allowed to return the system to

- proper operation. Failure to correct the system within this time frame will result in the system being classified as a failing system (section 1.9.4.1, Figure 1-2).
- e. If an annual report, as described in section 1.9.3, for a system identifies that an effluent sample fails to meet the limits stipulated on the installation permit, and the required resampling of the system did not occur, then the regulatory authority will issue the “Failure to Perform Operation, Maintenance, and Resampling of Your Extended Treatment Package System” letter provided in the DEQ program instruction, Extended Treatment Package System Program Letters.

If resampling as described in this section does not occur by the date provided in the Failure to Resample letter, then the actions will be considered a refusal of service as described in section 1.9.5, and the enforcement procedures provided in section 1.9.5 shall be followed by the regulatory authority.

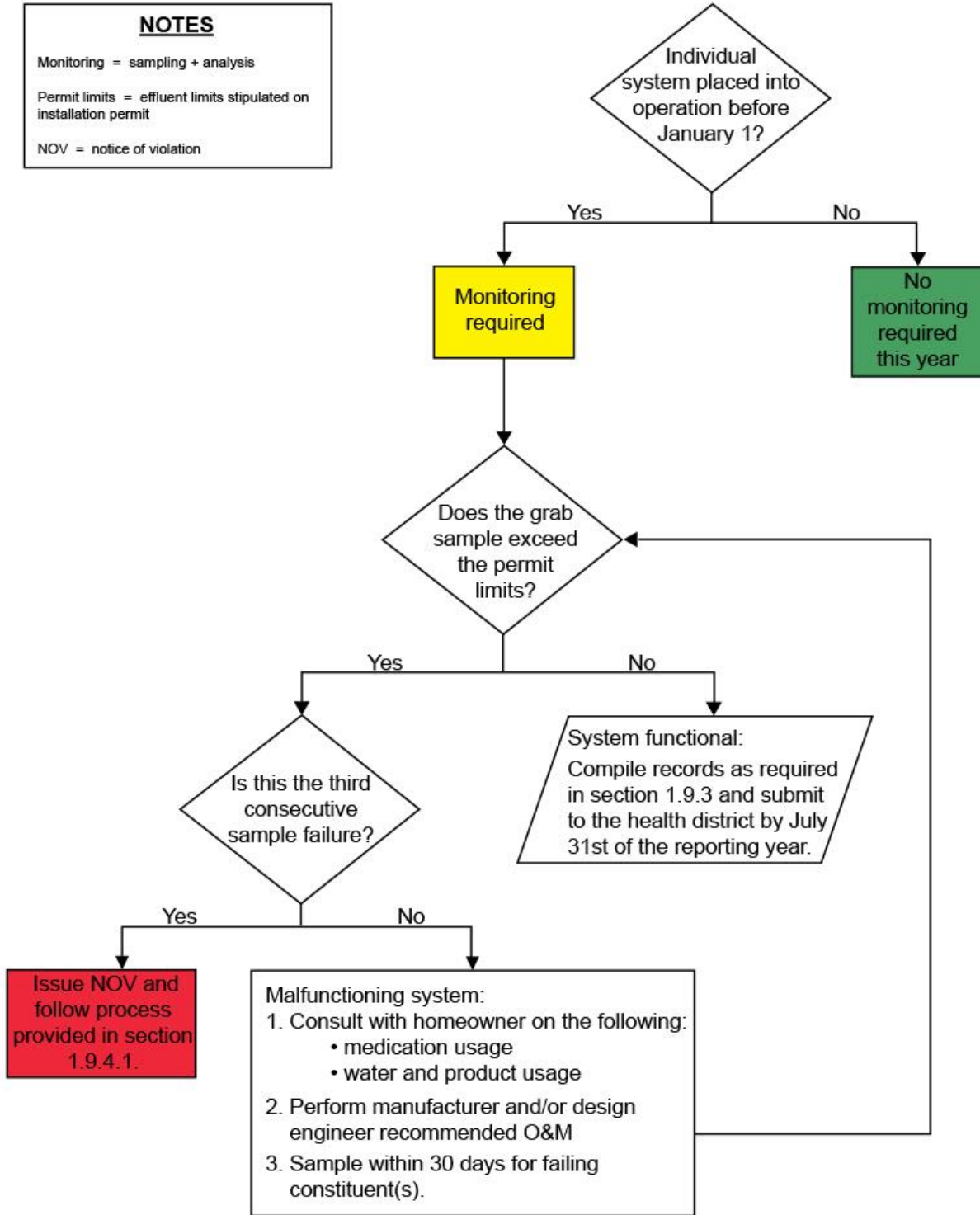

Figure 1-1. Individual treatment system sampling process.

### 1.9.3 Annual Reporting of Managed Operation, Maintenance, and Monitoring

The annual reporting period is from July 1 of the preceding year through June 30 of the reporting year. Annual reporting is the responsibility of the property owner, and DEQ recommends that property owners have their service provider compile and submit their annual report. Beginning July 1, 2018, annual reporting must be electronically submitted through OnlineRME ([www.OnlineRME.com](http://www.OnlineRME.com)). OnlineRME is a web-based wastewater management reporting tool for DEQ, health districts, service providers, manufacturers, and property owners. Annual reports are public records and are searchable through OnlineRME.

To set up an OnlineRME account, service providers must register at <http://www.onlinerme.com/OnlineRMEMarketing/ormregister.htm>. Service providers will receive an ID number for their company. If you have questions about how to use OnlineRME, call (888) 963-9608 or email [info@onlinerme.com](mailto:info@onlinerme.com). For help files, tutorials and tips for navigating through OnlineRME go to <https://onlinerme.atlassian.net/wiki/spaces/ON/overview>.

Service providers can use the OnlineRME program for their business for free. OnlineRME has a reporting fee (\$3.00) that is assessed once for each inspection report at each property each reporting year. The fee is paid by the service provider. A follow-up inspection report incurs no OnlineRME fee as long as the report is entered within 6 months of the last paid inspection report submitted on the same property.

#### Activities to be Reported:

- Routine—To meet OMM annual reporting requirements under section 1.9.1.
- Intermittent—Prescheduled inspections performed between the required “Routine” inspections, such as an ETPS inspection 6 months from a routine inspection. Partial inspections are acceptable if appropriate (e.g., warranty inspections of ETPS’s at 6-month intervals).
- Follow Up—An inspection that provides new information, or documents corrections of deficiencies found in a previous OnlineRME inspection report. All system components worked on or affected by components that were worked on must be fully inspected.
- Startup—The initial inspection of a treatment system performed immediately after the system is fully installed. All system components must be fully inspected.
- Complaint—An inspection of a treatment system as instructed by a health district notification letter.
- Property Sale (optional)—An inspection performed for a property sale. All system components must be fully inspected.

The property owner responsible for the treatment system under IDAPA 58.01.03 shall ensure the following annual reporting requirements are met:

1. Annual report for each property owner
  - a. Submit an inspection report to OnlineRME for the reporting period as required under section 1.9.1.
  - b. Mail a copy of all laboratory records for effluent sampling as described in section 1.9.2 (if required) to the health district.

- c. Mail a copy of each chain-of-custody form associated with each effluent sample as described in section 1.9.2 (if required).
2. If annual reporting requirements are not complete for any property owner who the service provider is responsible for providing the annual report to, DEQ recommends including an explanation with that property owner's records within the annual report.
3. Annual report exemptions
  - a. A property owner may be exempt from effluent testing based upon extreme medical conditions.  
Annual operation and maintenance on the property owner's treatment system shall not be exempt due to medical conditions, and record of annual operation and maintenance shall still be submitted with the property owner's annual report.
  - b. A service provider contracted by a property owner to fulfill annual reporting requirements may be exempt from reporting annual OMM for an individual property owner if that owner's activities fall within the guidelines of section 1.9.5.  
The service provider should still report the activities described in section 1.9.5 for each property owner exempt from annual reporting based on the guidelines in section 1.9.5.
4. Annual reporting process
  - a. The annual report shall be submitted to the local health district by the service provider on behalf of the property owner through OnlineRME no later than July 31 of each year for the preceding 12-month period.  
The annual report shall be submitted to the local health district that issued the subsurface sewage disposal permit for the treatment system.
  - b. The local health district shall provide whoever submitted the annual report a written response within 45 days of receipt of the report detailing compliance or noncompliance with septic permit requirements.
    - 1) The service provider should inform individual property owners of their compliance status.
    - 2) All correspondence from the health district regarding a noncompliant annual report shall be copied to DEQ.
5. Delinquent annual reports
  - a. If the property owner, or service provider contracted to submit the property owner's annual report does not submit the annual report by July 31 of the reporting year, then the local health district shall send the property owner, or service provider contracted to submit the property owner's annual report, a reminder letter providing a secondary deadline of August 31 of the reporting year for the annual report submission. The reminder letter shall detail the report requirements and that failure to submit the annual report by the secondary deadline will result in the health district forwarding a notice of nonreport to DEQ. DEQ may seek any remedy available under IDAPA 58.01.03 including, without limitation, requiring the property owner to replace the treatment system with another system, as outlined in section 1.9.4.
  - b. All correspondence from the health district regarding delinquent annual reports shall be copied to DEQ.

### 1.9.4 Treatment System Failure, Disapproval, and Reinstatement

Commercially manufactured and alternative wastewater treatment systems must be approved by DEQ (IDAPA 58.01.03.004.10 and 58.01.03.009.01). Installation of a commercially manufactured or alternative wastewater treatment system requires a subsurface sewage disposal permit pursuant to IDAPA 58.01.03.005. As part of the alternative system approvals for commercially manufactured or alternative wastewater treatment systems, DEQ defines the specific circumstances under which the treatment systems may be installed, used, operated, and maintained within the alternative treatment system guidance (IDAPA 58.01.03.009.03 and 58.01.03.005.14).

If a commercially manufactured or alternative wastewater treatment system product is not shown to be installed, used, operated, or maintained according to DEQ requirements, then DEQ may pursue enforcement against a property owner and seek those remedies available under IDAPA 58.01.03. Enforcement and remedies against the property owner may include a determination that the treatment system has failed and the requirement that the property owner replace the treatment system with a different system authorized by DEQ. Replacement may include installing another commercially manufactured wastewater treatment system approved by DEQ, or engineering and installing another alternative system that is capable of meeting the requirements of the property owner's subsurface sewage disposal permit. If a commercially manufactured or alternative wastewater treatment system is not shown to comply or consistently function in compliance with IDAPA 58.01.03 and specified OMM requirements, DEQ may disapprove the commercially manufactured wastewater treatment product or classify the alternative wastewater treatment system as a failing system for failure to meet the intent of the rules related to wastewater treatment (IDAPA 58.01.03.003.13.a). Reasons for DEQ enforcement, which may include seeking remedies against a property owner or disapproval/failure classification of a commercially manufactured or alternative wastewater treatment product as outlined herein, include, but are not limited to, the following:

1. Failure to submit an annual report by the secondary deadline of August 31.
2. Malfunctioning systems are defined as any system that fails to receive annual operation and maintenance or exceeds the effluent reduction levels for any constituent specified in the subsurface sewage disposal permit (i.e., TSS, CBOD<sub>5</sub>, or TN).
3. Property owner's commercially manufactured wastewater treatment product or alternative treatment system has been determined to be a failing system. Failing commercially manufactured wastewater treatment systems are defined in section 1.9.2.

#### 1.9.4.1 Failing System Enforcements

The regulatory authority shall follow the procedures below after a wastewater treatment system has been determined to be a failing system (Figure 1-2):

1. When the regulatory authority is notified that a system is failing, a notice of violation (NOV) shall be issued to the property owner. The property owner shall have the opportunity to hold a compliance conference with the regulatory authority to enter into a consent order.
2. Consent orders should allow a property owner a 12-month period to return the system to proper operation or replace the failing system.

- a. Over this 12-month period, the property owner should have their service provider service the wastewater treatment system at least monthly.
- b. Monthly effluent samples should be taken by the service provider until the wastewater treatment system passes 3 consecutive monthly samples.  
 Three consecutive passing monthly samples taken 1 month apart would be cause for the regulatory authority to terminate the consent order and NOV, and reclassify the system as compliant.
- c. OMM records as described in sections 1.9.1 and 1.9.2 should be submitted to the regulatory authority on a monthly basis as part of the consent order.
- d. If the commercially manufactured wastewater treatment system cannot produce 3 consecutive monthly samples over the 12-month period, then the system may be replaced with another alternative system that meets the effluent quality requirements based upon applicable site conditions.
- e. Replacement systems must meet the treatment requirements of the original septic permit. Appropriate replacement systems will be determined on a case-by-case basis.



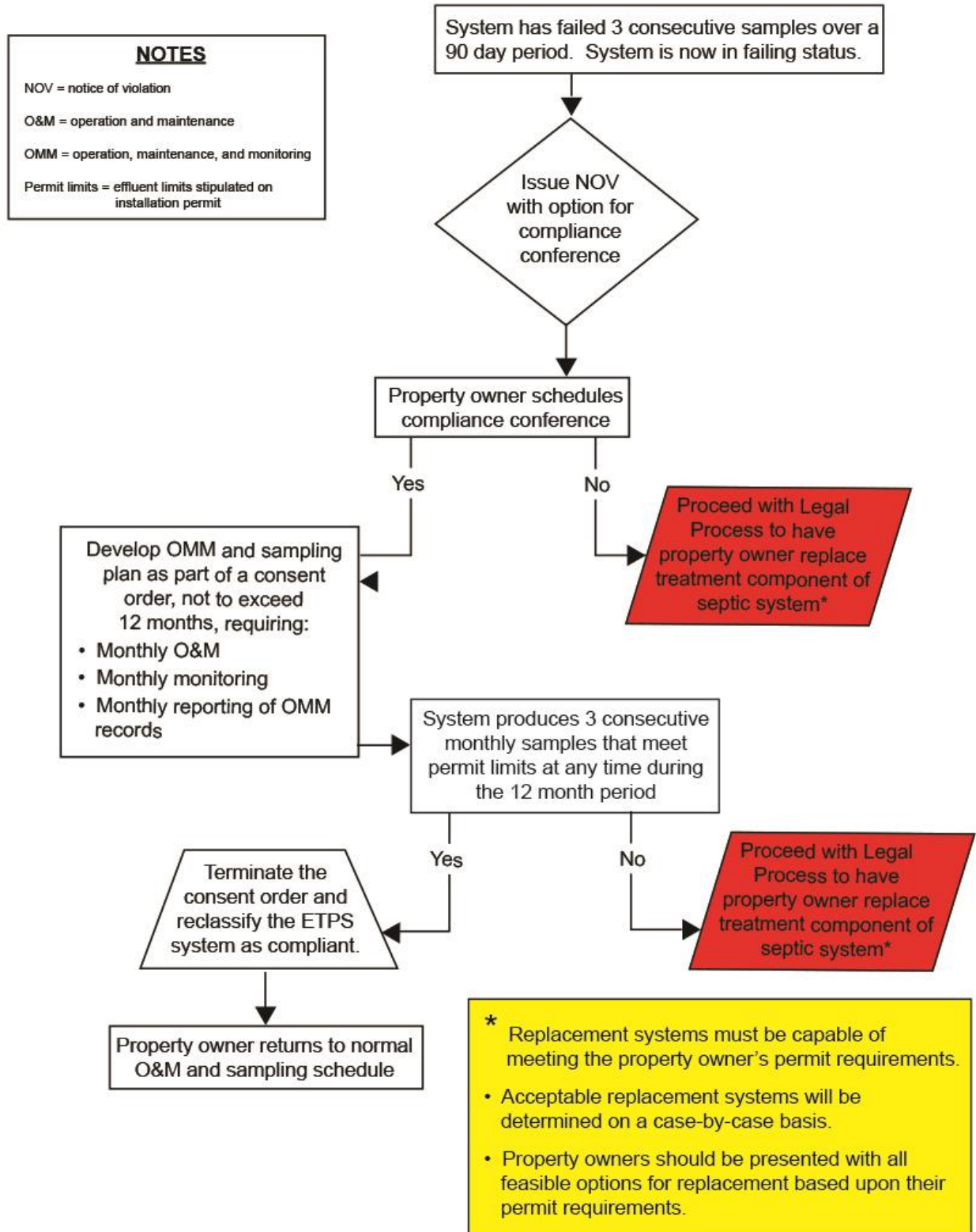

Figure 1-2. Failing wastewater treatment system enforcement flowchart.

### **1.9.4.2 Commercially Manufactured Wastewater Treatment System Disapproval**

In addition to determining a particular system is a failing system as described in section 1.9.4.1, if DEQ determines that a commercially manufactured wastewater treatment system cannot consistently function in compliance with IDAPA 58.01.03, then DEQ may disapprove the product (IDAPA 58.01.03.009.04). A written notice of DEQ's intent to disapprove the commercially manufactured wastewater treatment system will be provided following Idaho Code §67-52 and sent to the wastewater treatment system manufacturer, , and health districts. The commercially manufactured wastewater treatment system manufacturer will be allowed an opportunity to respond before product disapproval. Upon disapproval of a manufacturer's wastewater treatment system product line, the health districts shall not issue a septic permit on new applications for the commercially manufactured wastewater treatment system product line from the disapproved manufacturer. OMM requirements for existing installations of the commercially manufactured wastewater treatment system product line will not be affected by the product disapproval per section 1.4.2.2.3.

### **1.9.4.3 Commercially Manufactured Wastewater Treatment System Reinstatement**

Upon commercially manufactured wastewater treatment system product disapproval, manufactures will resubmit for provisional approval per section 1.4.2.2.1.

## **1.9.5 Property Owner Operation, Maintenance, or Monitoring Requirements**

It is the property owner's responsibility to store, treat, and dispose of wastewater generated on their property (IDAPA 58.01.03.002.04.a.i). Additionally, IDAPA 58.01.03.005.14 allows the Director to require that specific operation, maintenance, and monitoring procedures be observed as a condition of issuing a subsurface sewage disposal permit. Individual property owners are responsible for ensuring that the operation, maintenance and monitoring conditions associated with their ETPS subsurface disposal permit are met. Failure of an individual property owner to have the required OMM services completed is considered a violation of IDAPA 58.01.03.012.01. OMM and reporting must be performed by an approved service provider and third-party tester. Actions engaged in by a property owner that may be considered a violation of rules include but are not limited to the following:

1. Refusal to maintain the wastewater treatment system in operating condition (e.g., refusal to replace broken components or refusal to provide electricity to the unit).
2. Refusal to meet their permit's OMM and reporting requirements.
3. Failure to submit or have their contracted service provider submit the annual report.

### **Failure to Perform Required OMM and Reporting Enforcement Procedures**

Upon failure of an individual property owner to maintain and/or monitor their system as described in section 1.9.5, the following guidelines apply:

1. The regulatory authority shall issue Letter B with the associated enclosure provided in the DEQ program instruction, Extended Treatment Package System Education and Enforcement Letters.
  - a. Letter B shall be sent to the property owner by certified mail and copied to the associated service provider.

- b. The property owner is responsible for working with the regulatory authority and the service provider to address their delinquent responsibilities. The service provider should contact the regulatory authority and associated property owner 30 days after receiving Letter B to inform the regulatory authority of the property owner's voluntary compliance status.
2. If the property owner fails to voluntarily comply with the 30-day time frame, then the regulatory authority shall issue Letter C provided in the DEQ program directive, Extended Treatment Package System Education and Enforcement Letters.
  - a. Letter C shall be sent to the property owner by certified mail and copied to the associated service provider.
  - b. The property owner is responsible for working with the regulatory authority and their service provider to address their delinquent responsibilities. The service provider should contact the regulatory authority and associated property owner by the voluntary compliance date provided in Letter C to inform the regulatory authority of the property owner's voluntary compliance status.
3. If the property owner fails to voluntarily comply by the date provided in Letter C, then the regulatory authority may submit an Enforcement Referral Memorandum to DEQ to ensure compliance with the property owner's subsurface sewage disposal permit requirements.

## 1.10 Service Provider Transition

Recognizing the need to create a more effective and useful means of approving and overseeing service providers and expanding choices of service for private property owners, the Idaho State Legislature approved Docket No. 58-0103-1501. Effective July 1, 2017, ETPSs will be operated and maintained by approved service providers (section 1.6).

The first ETPS annual reports under the service provider model shall be submitted by July 31, 2018. This 1-year transition allows property owners to contract with an approved service provider, to have proper operations and maintenance conducted on their units and to submit completed annual reports. DEQ and the health districts will work together to inform property owners with installed ETPS of the changes in OMM responsibilities.

### 1.10.1 Transition Sampling and Maintenance Requirements

General approved ETPS must be maintained by an approved service provider, sampled if permitted for nitrogen reduction less than 27 mg/L, and have annual reports submitted per section 1.4.2.2.2.

ETPS with provisional approval permitted before July 1, 2016, must be maintained by an approved service provider (with or without the manufacturer's endorsement) and have an annual report submitted.

For ETPS with provisional approval permitted after July 1, 2016, the maintenance, sampling, and reporting is the responsibility of the system manufacturer per section 1.4.2.2.1.

Disapproved ETPS must be maintained by an approved service provider (manufacturer's endorsement not required) and have an annual report submitted per section 1.4.2.2.3.

### 1.10.2 Transition Enforcement Protocol

A transitional enforcement protocol will be used for ETPS installations required to submit annual reports on July 31, 2018, through July 31, 2020. After education and outreach efforts by DEQ and the health districts, those property owners who refuse service, fail to submit annual reports, or have general approved systems permitted for nitrogen reduction less than 27 mg/L that are not meeting permit requirements, will be referred by the health districts to DEQ for enforcement.

During this transition period, all letters required by the DEQ Subsurface Sewage Disposal ETPS Program Instruction will be produced and mailed by DEQ.

Only after systems referred to DEQ for enforcement have been brought back into full regulatory compliance will the health districts be responsible for monitoring and future compliance.

## 2 Soils and Ground Water

### 2.1 Soil Texture and Group Determinations

Revision: January 30, 2017

#### 2.1.1 Determining Soil Textural Classifications

Soil texture is determined by the proportion of three separates: sand, silt, and clay. It is one of the most important characteristics of soil for water movement because of its relationship to pore size distribution and pore continuity. Permeability, aeration, and drainage are all related to the soils' ability to filter and adsorb or otherwise retain pollutants for treatment. Sizes of the major separates are shown in Table 2-1.

**Table 2-1. Sizes of mineral, soil, and rock fragments.**

Material	Equivalent Diameter <sup>a</sup>	Passes Sieve #
Clay	<0.002 mm	425
Silt	0.002–0.05 mm	270
Very fine sand	0.05–0.10 mm	140
Fine sand	0.10–0.25 mm	100
Medium sand	0.25–0.50 mm	50
Coarse sand	0.50–1.00 mm	16
Very coarse sand	1.00–2.00 mm	10
Gravel	2.00 mm–75 mm	3 in.
Cobbles	75–250 mm	10 in.
Stones	250–600 mm	24 in.
Boulders	>600 mm	—

a. Natural Resources Conservation Service, National Soil Survey Handbook (NSSH) Part 618 (Subpart A), 618.46 (D) and 618.31(K) 3ii

Notes: millimeter (mm); inches (in.)

The Soil Textural Classification used by Idaho was adopted from the United States Department of Agriculture (USDA). Soil textures of proposed soil absorption sites are determined according to these guidelines. Once the textures have been determined, then the soil design groups may be specified for the absorption system design. Characteristics of each soil texture are shown in Table 2-2. To determine the texture classification of soils, refer to Table 2-2, Table 2-3, and Figure 2-1 for summaries of the soil particle distributions and percentages in each of the textures. Refer to Figure 2-2 for a flowchart of the steps for determining soil classification.

**Table 2-2. Soil textural characteristics.<sup>a</sup>**

Soil Texture	USDA Soil Textural Classification	Dry Soil Description (0%-25% available moisture percent <sup>b</sup> )	Moist Soil Description (75%-100% available moisture percent)	
			Ball <sup>c</sup> Formation	Ribbon <sup>d</sup> Between Thumb and Finger
Coarse	Fine sand Loamy fine sand Sand Coarse sand Loamy coarse sand Loamy sand Very fine sand	Dry, loose, will hold together if not disturbed, loose sand grains on fingers with applied pressure	Wet, forms a weak ball, loose and aggregated sand grains remain on fingers, darkened color, heavy water staining on fingers	Will not ribbon
Moderately coarse	Sandy loam Fine sandy loam Very fine sandy loam Coarse sandy loam Loamy very fine sand	Dry, forms a very weak ball, aggregated soil grains break away easily from ball	Wet, forms a ball with wet outline left on hand, light to medium water staining on fingers	Makes a weak ribbon between thumb and forefinger
Medium	Sandy clay loam Loam Silt loam Silt	Dry, soil aggregations break easily, no moisture staining on fingers, clods crumble with applied pressure	Wet, forms a ball with well-defined finger marks, light to heavy soil/water coating on fingers	Ribbons between thumb and forefinger
Fine	Clay Clay loam Silty clay loam Sandy clay Silty clay	Dry, soil aggregations easily separate, clods are hard to crumble with applied pressure	Wet, forms a ball, uneven medium to heavy soil/water coating on fingers	Ribbons easily between thumb and forefinger

a. Adapted from USDA Natural Resource Conservation Service (NRCS). 2005. *Estimating Soil Moisture by Feel and Appearance*. Program Aid Number 1619.

b. Available moisture percent is that percent of the available water-holding capacity of the soil occupied by water.

c. Ball is formed by squeezing a handful of soil very firmly with one hand.

d. Ribbon is formed when soil is squeezed out of hand between thumb and forefinger.

**Table 2-3. Soil textural proportions.**

<b>USDA Soil Textural Classifications</b>	<b>Sand (%)</b>	<b>Silt (%)</b>	<b>Clay (%)</b>
Sand	>85	<15	<10
Loamy sand	70–90	<30	0-15
Sandy loam	43–85	<50	<20
Loam	23–52	28-50	7–27
Silty loam	<50	50–88	<27
Silt	<20	>80	<12
Sandy clay loam	45–80	<28	20–35
Clay loam	20–45	15–53	27–40
Silty clay loam	<20	40–73	27–40
Sandy clay	45–65	<20	35–55
Silty clay	<20	40–60	40–60
Clay	<45	<40	>40

Basic textural names may be modified if the soil mass contains 15%–95% of stones, cobble, or gravel by adding the name of the dominant rock fragment:

- Gravelly or stony = 15%–35% of the soils volume is rock fragments.
- Very gravelly or very stony = 35%–60% of the soils volume is rock fragments.
- Extremely gravelly or extremely stony = 60%–95% of the soils volume is rock fragments.
- 95% or more should take the name of the geological type, such as granite, gneiss, limestone, or gravel.

### TGM-Soil Texture Flowchart Triangle

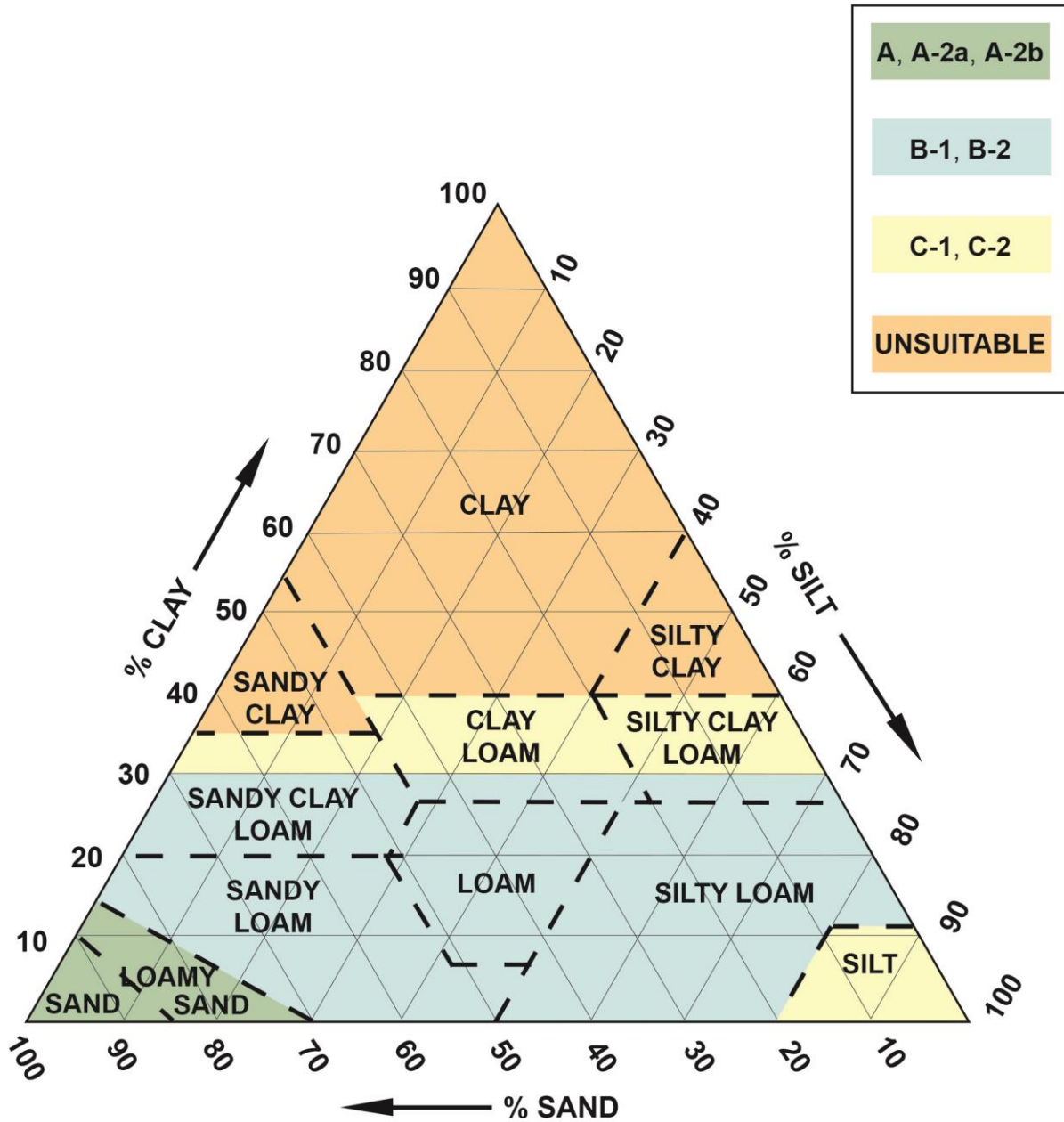

A black and white version is provided in Appendix B.

Figure 2-1. United States Department of Agriculture soil textural triangle.



### TGM-Soil Texture Flowchart

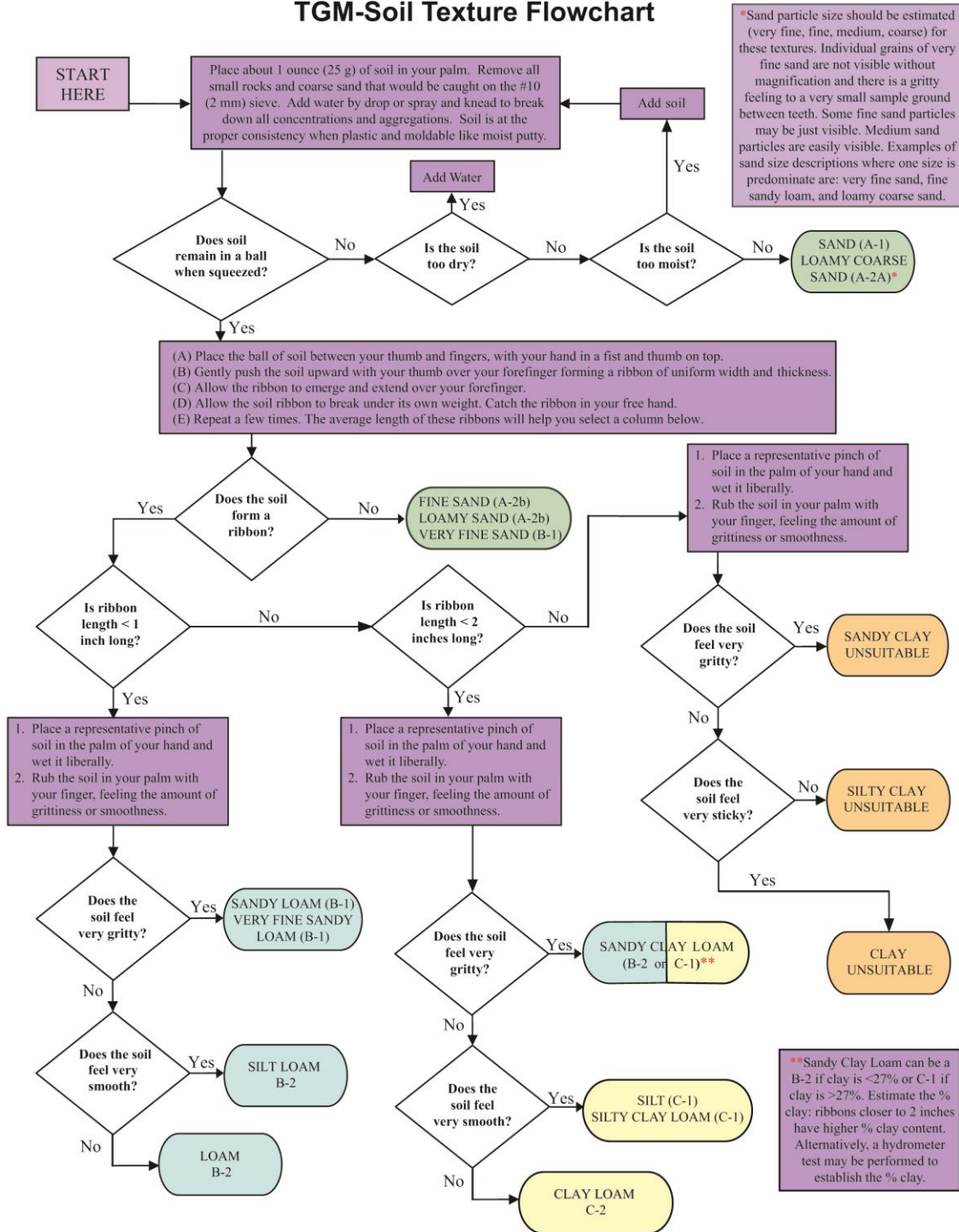

A black and white version is provided in Appendix B.

Figure 2-2. Soil texture determination flowchart.

### **2.1.2 Soil Design Groups and Subgroups**

This section is provided as a guide to field environmental health personnel in making technical allowances for standard systems and for health districts to use in selecting alternative systems. The required absorption area of a subsurface sewage disposal system depends on the texture of the soils in the proposed disposal system location. In a similar manner, required separation distances between the disposal area and features of concern, such as wells, surface water, and ground water, depend on soil texture. Soils surrounding the disposal system and those below it may not be the same.

The soil design group or subgroup (Table 2-4) used to determine the vertical separation distances describe the finest-textured soils adjacent to and beneath the drainfield for the effective soil depth. The soil design group or subgroup (Table 2-4) used to determine the horizontal separation distances to surface water is the coarsest-textured soils adjacent to and beneath the drainfield for the effective soil depth. Effective soil depths are described in sections 2.2.2, 2.2.3, and 2.2.5 for standard and basic alternative systems. Some complex alternative treatment systems have effective soil depth reductions that impact vertical separation distances. Complex alternative treatment system effective soil depth reductions are described within each treatment system's individual guidance section.

All other soil textures and some soil features (i.e., gravel, coarse sand, all clays, organic muck, claypan, hardpan, and duripan) are unsuitable for installing a standard drainfield system.

**Table 2-4. Soil textural classification design groups.**

Soil Design Group	Soil Design Subgroup	Soil Textural Classification	Application Rate (GPD/ft <sup>2</sup> ) <sup>a</sup>
NS <sup>b</sup>	NS	Gravel Coarse sand	NS
A	A-1	Sand <sup>c</sup>	1.2
	A-2a	Loamy coarse sand	1.0
	A-2b	Fine sand Loamy sand	0.75
B	B-1	Very fine sand Sandy loam Very fine sandy loam	0.6
	B-2	Loam Silt loam Sandy clay loam (≤27% clay)	0.45
C	C-1	Silt Sandy clay loam <sup>d</sup> Silty clay loam <sup>d</sup>	0.3
	C-2	Clay loam <sup>d</sup>	0.2
NS	NS	Sandy clay Silty clay Clay Organic muck Duripan Hardpan Claypan	NS

a. Application rates are for domestic strength wastewater.

b. Not suitable (NS) for installation of a subsurface sewage disposal system.

c. See medium sand definition (section 3.2.8.1.2) for a manufactured material that may be acceptable for use.

d. Soils without expandable clays.

Notes: gallons per day per square foot (GPD/ft<sup>2</sup>)

### 2.1.3 Soil Design Subgroup Corrections

A soil design subgroup may be lowered as indicated in this section. (**Subgroup correction is used to determine the application rate only; it will not change surface water or ground water separation requirements.**)

1. Soil with moderate or strong platy structure should be lowered one subgroup for design purposes.
2. Soil should be lowered one subgroup if 35%–60% of its volume is rock fragments (very gravelly, very stony).
3. Soil should be lowered by two subgroups if 60%–95% of its volume is rock fragments (extremely gravelly, extremely stony).
4. Soil with 95% or greater rock fragments is unsuitable as an effective soil for subsurface sewage disposal.
5. Uniform fine and very fine sand (e.g., blow sands) should be lowered two subgroups for design purposes. Soils that qualify for this modification have a coefficient of uniformity less than three ( $C_u < 3.0$ ).

**Example:**

A soil evaluation results in the designation of loamy sand with rock fragment volumes estimated at 70% of the total soil volume within the effective soil depth below the drainfield installation. The loamy sand would be assigned a soil design subgroup of A-2b consistent with Table 2-4. Due to the estimated volume of rock fragments, the soil design subgroup would then be lowered by two subgroups resulting in an assigned soil design subgroup of B-2. Based on these determinations, the drainfield would be sized consistent with the B-2 soil application rate (0.45 GPD/ft<sup>2</sup>; Table 2-4) to increase the available soil surface available for effluent treatment due to the soil surface being reduced by large fraction rock. However, both the required vertical (effective soil depth, IDAPA 58.01.03.008.02.c) and the horizontal separation distances (IDAPA 58.01.03.008.02.d) shall meet the requirements for soil design group A soils.

## 2.2 Separation Guidelines

Revision: June 21, 2018

### 2.2.1 Separation Distance Hierarchy

Separation distances to features of concern or interest are required by IDAPA 58.01.03. Separation distances include both vertical and horizontal separation distances, including effective soil depths, to features of concern, interest, or limiting layers. This section of this manual provides guidance on reducing separation distances based on site-specific conditions. The guidance on reducing separation distances is provided to help find permitting solutions for difficult sites that may not meet the full separation distances required by IDAPA 58.01.03. These reductions will only be granted after it is documented that the site cannot meet the separation distances required by IDAPA 58.01.03. When performing a site evaluation for issuing a subsurface sewage disposal permit, the following separation distance hierarchy should be followed:

1. IDAPA 58.01.03
2. Technical allowance (IDAPA 58.01.03.010.01)
3. TGM guidance
4. Variance (IDAPA 58.01.03.010.02–06)

This hierarchy does not apply to specific alternative system guidance for reducing effective soil depth to limiting layers. If the guidance from this section of this manual is used for any new or replacement subsurface sewage disposal permit, justification must be included in the permit documentation explaining why this guidance was used over the requirements of IDAPA 58.01.03.

### 2.2.2 Effective Soil Depth to Porous Layers or Ground Water

Table 2-5 provides guidance for determining effective soil depth from the bottom of absorption fields to very porous layers or to normal high ground water.

**Table 2-5. Minimum effective soil depth (feet) by soil design subgroup to the limiting layer.**

Limiting Layer	Soil Design Subgroup (feet)					
	A-1	A-2	B-1	B-2	C-1	C-2
Fractured bedrock or other porous layer	6	5	4	3	3	2.5
Normal high ground water	6	5	4	3	3	2.5
Seasonal high ground water	1	1	1	1	1	1

### 2.2.3 Effective Soil Depths to Impermeable Layers

Table 2-6 may be used to determine the effective soil depth below absorption fields to impermeable layers, such as dense clays, bedrock, or caliche if the approval conditions contained in this section can be met.

**Table 2-6. Effective soil depth (feet) to impermeable layers.**

Slope (%)	Acres (feet)				
	1	2	3	4	5 or more
20	3.0	2.8	2.5	2.3	2.0
16	3.2	2.9	2.6	2.4	2.0
12	3.4	3.1	2.7	2.4	2.0
8	3.6	3.2	2.8	2.5	2.0
4	3.8	3.4	2.9	2.5	2.0
0	4.0	3.5	3.0	2.5	2.0

Approval Conditions:

1. Impermeable layer is that soil or geological feature less permeable than a subgroup C-2 soil. The layer must be contiguous and unbroken beneath the absorption field and its replacement area for at least 10 feet in any direction from these sites.
2. Adjacent lots are of equal size or larger.
3. This guidance is applicable to standard systems and capping fill trench alternatives.
4. Minimum distance to a property line on the downslope side of the absorption field and its replacement area must be at least 10 feet.
5. Lateral hydraulic conductivity of the effective soil should be able to transport the combined precipitation and wastewater flow through the soil without surfacing.

**2.2.4 Effective Separation Distance to Surface Water**

Reduction in separation distances to surface water from the requirements of IDAPA 58.01.03 are allowed as provided in section 2.2.4 as long as the hierarchy and documentation practices described in section 2.2.1 of this manual are followed. Each site should be reviewed on its own merits. Additional criteria, such as population density, watershed characteristics, and reasonable access to municipal sewer must be examined before an allowance for the reduction of separation distance to surface water is granted. The following conditions are in place for all surface water allowances:

1. Separation distance to surface water shall not be less than 100 feet.
2. Alternative systems may be required to achieve the reduction allowance.
3. No additional technical allowance may be granted to the reductions included in the sections below without following the formal variance procedure outlined in IDAPA 58.01.03.010.
4. Application for a variance under IDAPA 58.01.03.010 does not guarantee that a reduction in separation distance will be allowed.

**2.2.4.1 Reduction in Separation Distance to Surface Water without a Variance**

Table 2-7 shows the criteria for reducing separation distances to permanent or intermittent surface water based on soil design subgroups, vertical soil depth above surface water, and the vertical soil depth above any limiting layers.

**Table 2-7. Criteria for reducing separation distances to permanent or intermittent surface water.**

Separation Distance (feet)	Soil Design Subgroup	Soil Reduction (feet)	Vertical Soil Depth Above Water: >25 feet; and Depth to Limiting Layer: >10 feet	Maximum Separation Reduction (feet)	Minimum Separation Distance to Surface Water (feet)
300	A-1	0	25	25	275
300	A-2	25	25	50	250
200	B-1	0	25	25	175
200	B-2	25	25	50	150
100	C-1	0	0	0	100
100	C-2	0	0	0	100

The distance to permanent surface water may also be reduced to not less than 100 feet for all soil types when it can be demonstrated:

1. Either
  - a. The surface water is sealed so there is no movement of ground water into the surface water body, or
  - b. The surface water body is discharging into the ground water, and
2. There are no limiting layers between the drainfield elevation and the surface water elevation.

**2.2.4.2 Reduction in Separation Distance to Surface Water with a Variance**

Separation distances to surface water are in place to protect water quality, ecological health, and current and future beneficial uses of the resource. Septic tank effluent contains both nitrogen and phosphorous, which are nutrients that pose a eutrophication threat to surface water. If the separation distance from a drainfield to surface water is proposed to be decreased more than the limits outlined in section 2.2.4.1, an assessment must be done to evaluate the potential adverse effects that the nitrogen and phosphorous load may have on receiving surface waters. If the evaluation is favorable (i.e., no adverse impact is determined), supported by model outputs, and written recommendation for approval from DEQ is received, then a variance may be issued for a reduced separation distance.

**2.2.4.2.1 Supporting Documentation for a Reduced Separation Distance to Surface Water Variance**

Minimum documentation requirements to support a variance request are as follows:

1. The variance must follow all requirements specified in IDAPA 58.01.03.010 and be filed with the health district with a subsurface sewage disposal permit application.
2. The site evaluation process must be followed to obtain the minimum information necessary to support a subsurface sewage disposal permit, nutrient-pathogen (NP) evaluation, and phosphorous evaluation.
3. An NP evaluation must be performed to demonstrate site suitability based on minimum system design requirements, proposed system placement, and model outputs as outlined

in section 2.2.4.2.3 before performing a phosphorous evaluation as described in the on-site system surface water separation distance determination guidance and model.

4. The phosphorous evaluation must be performed to demonstrate site suitability based on minimum system design requirements, proposed system placement, and model outputs as outlined in section 2.2.4.2.3.

#### **2.2.4.2.2 Drainfield Design Requirements for a Reduced Separation Distance to Surface Water**

A drainfield proposed with a reduced separation distance to surface water as allowed under this variance procedure must meet the following minimum design requirements:

1. The drainfield shall be pressurized and designed based on section 4.19 of this manual.
2. The maximum installation depth of the drainfield in the native soil profile shall be 6 inches, and the proposed drainfield sites must meet the above-grade capping fill system criteria (section 4.3) or drip distribution system criteria (section 4.5).
3. Two full-size drainfields shall be installed under the initial permit, and alternating dosing between each drainfield shall be included in the system's operational design.
4. Replacement area for a third full-size drainfield must be reserved on the property.
5. No separation distance to surface water shall be reduced to less than 100 feet.
6. An alternative pretreatment system shall be installed after the septic tank that is capable of reducing total nitrogen to at least 27 mg/L. A greater total nitrogen reduction level may be required depending on the outcome of the NP evaluation.

#### *Restrictions on Drainfield Designs Necessary to Obtain Successful Outputs in Nutrient Evaluation Models*

IDAPA 58.01.03 specifies the minimum drainfield area required to adequately handle the specified volume of wastewater generated in the structure being permitted. It is acceptable for a system design to be in excess of the drainfield area required by IDAPA 58.01.03. To reduce the drainfields separation distance to permanent or intermittent surface water, it may require that the drainfield area is in excess of the minimum requirements stipulated in IDAPA 58.01.03. This may be due to the surface area and volume of soil below the drainfield necessary to sequester phosphorous constituents in the wastewater and reduce potential adverse impacts to surface water. If it is necessary to expand the drainfield to obtain successful outputs for the models described in section 2.2.4.2.3, the drainfield area in excess of the minimum requirements provided in IDAPA 58.01.03 is strictly limited to the original wastewater flows evaluated for the original permit application and cannot be used in the future for additional structures or existing structure expansion.

#### **2.2.4.2.3 Nutrient Evaluation Model Outputs for a Reduced Separation Distance to Surface Water**

To support a variance request for a reduced separation distance to surface water, two nutrient evaluations must be performed based on the following specific effluent nutrient values and minimum model outputs:



### *Nutrient-Pathogen Evaluation*

1. The maximum total nitrogen concentration of the effluent discharged to the drainfield shall be 27 mg/L.
2. All other standard NP evaluation criteria and output requirements apply.

### *On-Site System Surface Water Separation Distance Determination Guidance and Model*

1. The average phosphorous output from the septic tank shall be 8.6 mg/L.
2. The minimum phosphorous site life of receiving soils shall be 50 years for each drainfield.
3. If the minimum phosphorous site life can be met, then the surface water body must be evaluated to determine if it has a total maximum daily load (TMDL) limit for phosphorous based on the following:
  - a. If the water body is not TMDL limited for phosphorous, the subsurface sewage disposal permit may be issued.
  - b. If the water body is TMDL limited for phosphorous, its impact on the surface water body must be evaluated through an equivalency comparison between what may be permitted by rule (standard separation distances) and the reduced separation distance proposed.
    - 1) If the modeled impact of the system at the reduced separation distance is equivalent to, or less than, the impact of what could be permitted by rule then the subsurface sewage disposal permit may be issued.
    - 2) If the modeled impact of the proposed system at the reduced separation distance is greater than the impact of what could be permitted by rule, then the subsurface sewage disposal permit may not be issued.

### **2.2.5 Method of 72 to Determine Effective Soil Depths**

Often, effective soil depths, as required by IDAPA 58.01.03.008.02.c, are not achievable due to various site conditions. In response to this issue, section 2.2.2 provides guidance for reducing separation distances to limiting layers based upon soil design subgroups. In some situations, this guidance does not go far enough to address these site limitations, nor does it provide guidance on how to approach separation distances to limiting layers when the soil profile is variable and does not meet the minimum effective soil depths as described in IDAPA 58.01.03.008.02 or Table 2-5, or when the in-trench sand filter system design is used. To address these situations, use the method of 72.

The method of 72 assigns treatment units to soil design subgroups. Treatment units assigned to soil design subgroups are extrapolated from the effective soil depths required by IDAPA 58.01.03.008.02.c. Based on this rule, it can be determined that 72 treatment units are necessary from the drainfield-soil interface to the porous layer/ground water to ensure adequate treatment of effluent by the soil. Table 2-8 provides the treatment units assigned to each soil design subgroup.

**Table 2-8. Treatment units assigned to each soil design subgroup per foot and per inch.**

Soil Design Subgroup	Manufactured Medium Sand	A-1	A-2	B-1	B-2	C-1	C-2
Treatment units per 12 inches of soil	24	12	14.4	18	24	24	28.8
Treatment units per inch of soil	2	1	1.2	1.5	2	2	2.4

**2.2.5.1 Native Soil Profiles and the Method of 72**

When the soil profile contains multiple suitable layers, but no layer is thick enough to meet the separation guidance provided in IDAPA 58.01.03.008.02.c or Table 2-5, use the method of 72 to determine the suitable separation distance for the proposed drainfield site. The following example is based on the soil profile identified in Figure 2-3.

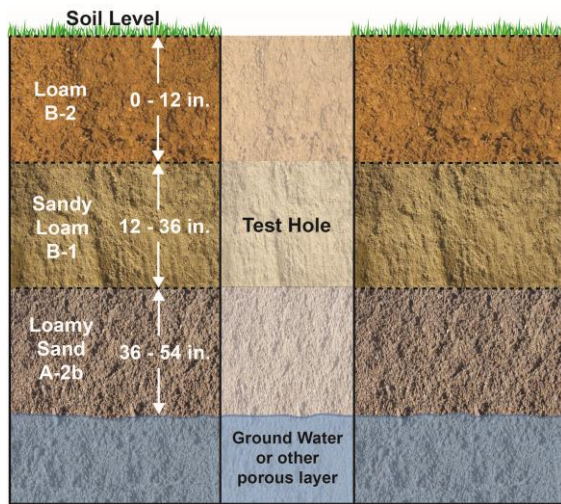

**Figure 2-3. Test hole profile used in example 1.**

**Example 1:**

Based upon the soil profile in Figure 2-3 and treatment units from Table 2-8, the following treatment unit equivalent would be ascribed:

$$\text{Treatment units} = 24 + 36 + 21.6 = 81.6$$

Since this is the treatment unit equivalent from grade to the porous layer or normal high ground water level, the installation depth must still be determined. In this example, the soil profile has 9.6 treatment units more than the minimum necessary to be considered suitable for a standard alternative drainfield. To determine installation depth, use the upper layer of the soil profile where the system will be installed and determine the treatment units per inch of soil. Once the treatment units per inch are known, the depth of allowable installation can be determined.

- 24 treatment units /12 inches of B-2 soil = 2 treatment units per inch
- Installation depth = 9.6 excess treatment units /2 treatment units per inch
- Installation depth = 4.8 inches

In this example, a standard basic alternative system can be permitted. The system design would be a capping fill trench with a maximum installation depth of 4.5 inches below grade.

**2.2.5.2 In-Trench Sand Filters and the Method of 72**

The method of 72 may also be used in determining the necessary depth of manufactured medium sand required for installation between a drainfield and the native soils overlying a limiting layer. Installation of manufactured medium sand may be necessary to access suitable soils below an unsuitable layer. Manufactured medium sand may be installed to any depth necessary to reach suitable soils as long as the excavation and installation of the manufactured medium sand meet the requirements in section 4.23. For porous limiting layers or normal high ground water, the drainfield installation depth must be sufficient to meet the method of 72. For impermeable limiting layers (e.g., bedrock), the drainfield installation depth must be sufficient to meet the minimum separation distance to impermeable layers required by IDAPA 58.01.03.008.02.c or Table 2-6 if the approval conditions can be met. Separation distances to impermeable layers cannot be reduced to less than the requirements above through the method of 72. The following example is based on the soil profile identified in Figure 2-4.

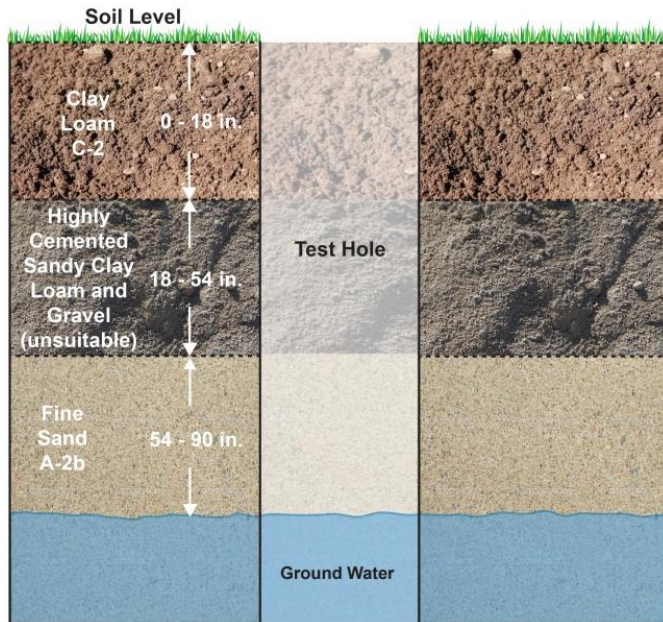

**Figure 2-4. Test hole profile used in example 2.**

**Example 2:**

In this example, the site soils must be excavated down to 54 inches to access suitable soils. This leaves 36 inches of A-2b soils, providing 43.2 treatment units. The amount of manufactured medium sand required to be backfilled prior to system installation would be determined as follows:

- Remaining treatment units =  $72 - 43.2 = 28.8$
- Depth of manufactured medium sand required = 28.8 treatment units remaining / 2 treatment unit per inch
- Depth of manufactured medium sand required = 14.4 inches

Thus the manufactured medium sand would be backfilled to a depth of 39.6 inches below grade. The drainfield would then be installed on top of the leveled manufactured medium sand.

*Note:* Regardless of the soil profile and treatment units needed, drainfields must be installed no deeper than 48 inches below grade per IDAPA 58.01.03.008.04. Drainfield depth restrictions only apply to the aggregate as defined in IDAPA 58.01.03.008.08 or the gravelless trench components approved in section 5.6. Manufactured medium sand may be installed to any depth necessary to reach suitable soils as long as the excavation and installation of the manufactured medium sand meet the requirements in section 4.23.

## 2.3 Evaluating Fill Material

Revision: October 23, 2012

This section provides general information for property owners to consider when filling a site, and it is not an approved alternative design. Property owners interested in pursuing a fill material project will need to get prior approval of their site modification plan. The site modification plan will be part of an application for a septic system permit. It is recommended that the property owner seek assistance from a certified soil scientist in preparing the site modification plan. Fill material typically has great variability, and property proposed for fill will require more extensive on-site investigation to determine the existence of restrictive layers.

### 2.3.1 Weathered Fill

Weathered or natural settling of fill will, over time, give fill similar characteristics to that of the natural soils. The annual precipitation cycle causes fill to settle and compact. Idaho has a wide range of precipitation, ranging from about 7 inches to near 80 inches. Differences in annual precipitation affect the rate and amount fill material will settle or compact. Normal settling and compaction will usually take at least 10 years to occur, depending on soil texture, fill depth, and precipitation. Fill in low precipitation zones may never become naturally compacted enough to prevent settling in the drainfield area. Table 2-9 shows the natural settling of fill. Fill depths in excess of the moisture penetration depths will not naturally settle in 10 years.

**Table 2-9. Natural settling of fill over a 10-year period.**

Soil Class	Precipitation Zones (inches)		
	7–16	16–24	>24
Depth of Moisture Penetration and Settling (inches)			
A	40	60	120
B	30	48	60
C	20	30	40

### 2.3.2 Supplemental Irrigation

Supplemental spray irrigation water can be used to aid settling where natural precipitation is not adequate. Generally, fill must be adequately saturated by irrigation for a minimum of 5 years to ensure natural settling. Ideally, potential drainfield sites in fill should be planned 5–7 years in advance. Adequate depth and area should be planned, and the site should be leveled before the settling period begins. For additional details, see section 2.3.8.

### 2.3.3 Fill Material Sites

Fill material sites must have a minimum of 12 inches of unsaturated suitable soil above the seasonal high ground water level. Judgment in site evaluation will be necessary when layers of different textures occur.

### **2.3.4 Fill Material**

If a fill has a continuous horizontal layer of a finer-textured soil, the settling should be calculated for the most restrictive soil. For example, most of a fill is an A soil, but a continuous layer of C soil occurs at 20 inches or less in a 7- to 16-inch precipitation zone. In this situation, the fill should be considered a C soil. If the layer occurred at 30 inches then the depth between 30 and 40 inches may lack natural compaction. Understanding field capacity of the soils is critical to determining if the fill material has adequately settled.

### **2.3.5 Acceptable Fill Material**

Fill material must be an acceptable soil type and free of trash, garbage, solid waste, demolition materials, woody debris (e.g., stumps, branches, sticks, forest slash, and mill yard debris), organic material (e.g., manure, grass and lawn clippings, biosolids, sludge, and compost), unsuitable soils, and large rocks. Based on the site evaluation, the fill material must be no more permeable than the next soil subgroup of the receiving soil. Fill material may be less permeable than the receiving soils.

### **2.3.6 Mechanical Compaction Not Authorized**

Mechanical compaction of fill soils is not an acceptable substitute to weathered fill. Mechanical compaction has its place in providing buildings with structurally stable level bases, essentially preventing the building from settling. The soil-based treatment system of a drainfield, while it too needs a stable base, is easily overcompacted resulting in horizontal flow paths and break out (a type of system failure), or greatly reduced long-term infiltration and subsequent system failure.

### **2.3.7 Site Preparation**

Thick vegetative mats should be removed. Prior to placement of any fill, the natural ground surface should be scarified or plowed to a depth of 6 to 8 inches. This will increase stability and avoid the problems associated with a layer of organic material. Include enough area to run compaction and settling tests. This area should not be included in the drainfield area calculations because the test pit excavations will destroy the area for use as a drainfield.

The original soil should not be compacted before the placement of fill. Compaction can easily happen at construction sites if equipment or other types of vehicles have been operated during periods when the site was wet. On sloping areas, preventing compaction is very critical because saturation zones can develop just above the compacted layer, creating stability problems. Loose soils with significant amounts of volcanic ash are particularly susceptible to compaction. No pneumatic-tired equipment should be permitted on the fill area and fill material in order to prevent soil compaction.

Sites should be avoided where fill has been dumped in piles for a long period and then leveled out because differential settling occurs. The calculation of settling time will begin after leveling.

### 2.3.8 Enhanced Weathering Procedures

Supplemental irrigation may be employed to shorten the fill weathering time. Enhanced weathering of fill is a process that mimics the yearly or annual hydrologic cycle of soil weathering. The fill soils are brought up to their field capacity by using an irrigation system to mimic rainfall, and then the fill soils are left to dry and settle. Irrigation application methods need to avoid erosion of the fill and formation of rills that allow runoff to occur. A sufficient timeline between irrigation sets needs to be determined based on soil transpiration or soil measurements. Natural weathering of fill material can be enhanced by using supplemental spray irrigation and drying. Fill depth and fill soil type are key factors in determining the length of time needed for this type of site modification.

Elements of a site modification plan for enhanced weathering procedures should include, but may not be limited to the following:

1. Site modification plan application information
  - a. Proposed fill area including
    - 1) Primary and replacement drainfield areas in square feet (ft<sup>2</sup>)
    - 2) Test pads of sufficient size are calculated. Testing pads are sacrificed by excavation to bottom of fill to determine soil structure/weathering.
  - b. Site map
2. Site evaluation
  - a. Topography
    - 1) Elevation
    - 2) Primary wind direction
  - b. Climate
 

Precipitation and evaporation based on the 30-year averages (this will be an important part of field capacity analysis and natural weathering for the test period)
  - c. Access
 

Equipment access for site ingress and egress
  - d. Setbacks
  - e. Ground water level determination
3. Soil characterization
  - a. Native soil horizons and native soil types
  - b. Effective soil depth determination
  - c. Soil structural characteristics
  - d. Percent rock/gravel
  - e. Limiting layers
4. Site modification plan details
  - a. Fill depth needed to achieve effective soil depth
  - b. Proposed soil type for fill
    - 1) Follow TGM particularly on sloped ground.
    - 2) Use information gained in the soil characterization (step 3) to determine fill soil type.
  - c. Determine fill soil field capacity.

- 1) Soil type for the fill will determine the field capacity of the soil.
- 2) A soil scientist should determine the volume of fill and corresponding field capacity for the fill. This step is critical to determine the amount of water to apply to the fill material.
- 3) The goal is to simulate a natural weathering cycle through artificial water sprinkler application.
- d. Irrigation water management plan
  - 1) The objective is to apply enough water through the sprinkler system to achieve the field capacity of the fill material.
  - 2) Describe the source of irrigation water, method of application, length of application based on calculated sprinkler flows, and length of the resting period.
  - 3) Supplemental water application must be through a metered supply with sprinkler coverage measured and monitored.
  - 4) Irrigation days with high winds and hot temperature (>90 °F) should be avoided as the water from the sprinkler system will drift and evaporate out of the fill material and not achieve field capacity.
  - 5) Soil lysimeters can be installed at several depths to measure field capacity and determine when sprinkler application can stop. The lysimeters provide certainty that the irrigation system is achieving field capacity.
  - 6) Without lysimeters, additional test pad areas are likely to be needed, along with potentially longer time frames to complete the enhanced weathering process.
  - 7) Sprinkler activity is on a month-by-month basis to achieve the equivalent of a 10-year soil weathering cycle for a deep fill project.
    - a) The sprinkler application period should occur during the growing season, which is typically May–October.
    - b) The water cycle must stop during the nongrowing season and allow the fill materials to completely dry out to replicate the weathering pattern.
    - c) Sprinkler activity should occur over two summers, with additional sprinkler activity in years 3 and 4 depending on the test pad results.
5. Submit plans for review.
6. Install fill material as per section 2.3.7 and any additional conditions identified in the plan review.
7. Monitoring
  - a. Monitor sprinkler application rate to confirm calculated time for the sprinkler set.
  - b. Monitor sprinkler coverage to ensure no areas are left dry. Ensure overlap of sprinkler coverage.
  - c. Monitor lysimeters to confirm field capacity has been met.
  - d. Fill material monitoring
    - 1) Test holes are first excavated with a soil auger to determine soil stability.
    - 2) Holes that collapse when the soil auger is removed indicate that the fill is not ready for further tests.
    - 3) Refill hole and tag or mark the spot as sacrificed. Do not test in this location again.
    - 4) If necessary, repeat test hole soil auger determination until test hole remains open and does not collapse.



This process will require extra weathering time before repeating test hole auger determination.

8. Fill material weathering tests
    - a. Excavate test hole with backhoe after the soil auger stability tests are successful.
      - 1) Test hole excavation needs to be done carefully.
        - a) Collapse of the test hole is likely in deep fill materials or with inadequate sprinkling.
        - b) Follow safety protocols for septic tank excavation. Be cautious of cave in and sidewall collapse.
        - c) Observe the soil structure. Look for massive collapses or sections of sidewall collapse—this is a failure.
        - d) Refill test hole and tag or mark the spot as sacrificed.
          - a. Do not test in this location again.
        - e) Additional sprinkling over the entire area is needed if areas have massive sidewall collapse.  
 Minor sidewall collapse may be acceptable as this can easily occur with poor excavation technique.
        - f) Observing the excavation is critical to determine if partial soil collapse was a result of the mechanical disturbance by the backhoe.
        - g) U-shaped trenches indicate unstable soil sidewalls and the need for additional weathering.
    - b. Use a geology pick to look for penetration on side walls.
      - 1) Follow test hole safety protocols.
      - 2) To check for compaction run a knife or geology pick point vertically on the pit face.
        - a) Penetration depth should be about 0.5 to 1 inch into the soil.
        - b) A change in resistance to the movement of this sharp object across the soil horizons indicates compaction.
      - 3) Very distinct platy structure or high bulk density also indicates compaction.
      - 4) Field soil densitometer tests should be run, and laboratory bulk density tests should be collected and analyzed. Compare results to normal soil values for the soil type.
    - c. If fill, other than sand, is loose or can be easily dug out by a gloved hand, then adequate settling has not occurred.
9. Fill is ready for installation of a septic system when the pick test, soil densitometer, and soil bulk density test show normal soil compaction.

## 2.4 Ground Water Level

Revision: October 31, 2013

Ground water is any water in Idaho that occurs beneath the surface of the earth in a saturated geological formation of rock or soil (IDAPA 58.01.03.003.14). Ground water may be present near the ground surface at normal and seasonal high levels. Seasonal high ground water level is the highest elevation of ground water that is maintained or exceeded for a continuous period of 1 week per year (IDAPA 58.01.03.003.15.a). Normal high ground water level is the highest elevation of ground water that is maintained or exceeded for a continuous period of 6 weeks per year (IDAPA 58.01.03.003.15.b).

Subsurface sewage disposal systems and septic tanks must maintain vertical separation distances from the ground water to the bottom of the drainfield (IDAPA 58.01.03.008.02.c) and top of the septic tank (IDAPA 58.01.03.007.17). Ground water may be present year-round or seasonally. Permanent (year-round) ground water levels may fluctuate through the year or remain fairly constant. Seasonal ground water levels can fluctuate greatly and are typically affected by runoff or irrigation practices. To ensure separation distances as required by IDAPA 58.01.03 to permanent or seasonal ground water levels are met, determining the normal and seasonal high ground water levels is important.

High ground water levels may be established by the presence of low chroma mottles, historic records, or actual ground water monitoring (IDAPA 58.01.03.003.15). DEQ recommends and prefers that actual ground water monitoring be performed prior to issuing a subsurface sewage disposal permit if the proposed site of a new system is suspected to be affected by ground water levels. This monitoring ensures that adequate separation distances are maintained from subsurface sewage disposal systems and ground water as required by IDAPA 58.01.03.008.02.c and fulfills the intent of the State of Idaho's ground water policy as outlined in Idaho Code §39-102.3.a and the intent of DEQ's ground water policy as outlined in IDAPA 58.01.11.006.05 to prevent contamination of ground water from any source to the maximum extent practical.

In situations where a repair permit must be issued to replace a failing subsurface sewage disposal system, it would be appropriate to use historic records or the presence of low chroma mottles to establish the normal and seasonal high ground water levels.

The following provides guidance on when and how to use low chroma mottles and historic records, and how to perform and interpret actual ground water monitoring.

### 2.4.1 Ground Water Monitoring

Ground water monitoring is the preferred method for determining ground water levels. Over a period of time, ground water levels can be established by recording elevation changes in the ground water's surface, observed through a permanent or temporary well.

### 2.4.2 Monitoring Wells

During preliminary site investigations prior to subsurface sewage disposal permit issuance, the most common type of monitoring well used is a temporary monitoring well. If continual ground water monitoring is required as a condition of the subsurface sewage disposal installation permit

(e.g., large soil absorption systems), permanent monitoring wells are recommended to be installed after permit issuance. The recommended installation and design of both of these well types are provided below.

### 2.4.2.1 Permanent Monitoring Wells

DEQ recommends that permanent monitoring wells be installed by a professional well driller and the Idaho Department of Water Resources be consulted to determine the need for a well permit and any required construction standards. Permanent wells should be cased, with perforations in the casing throughout the anticipated zone of saturation. An idealized permanent monitoring well for observing ground water of less than 18 feet deep is shown in Figure 2-5. If a permanent well will be used for water quality monitoring, it should be

1. Purged or otherwise developed to eliminate installation contamination and silt buildup.
2. Provided with a ground water seal at the annular space between the casing and natural ground to prevent surface water from entering the ground water along the casing's exterior.

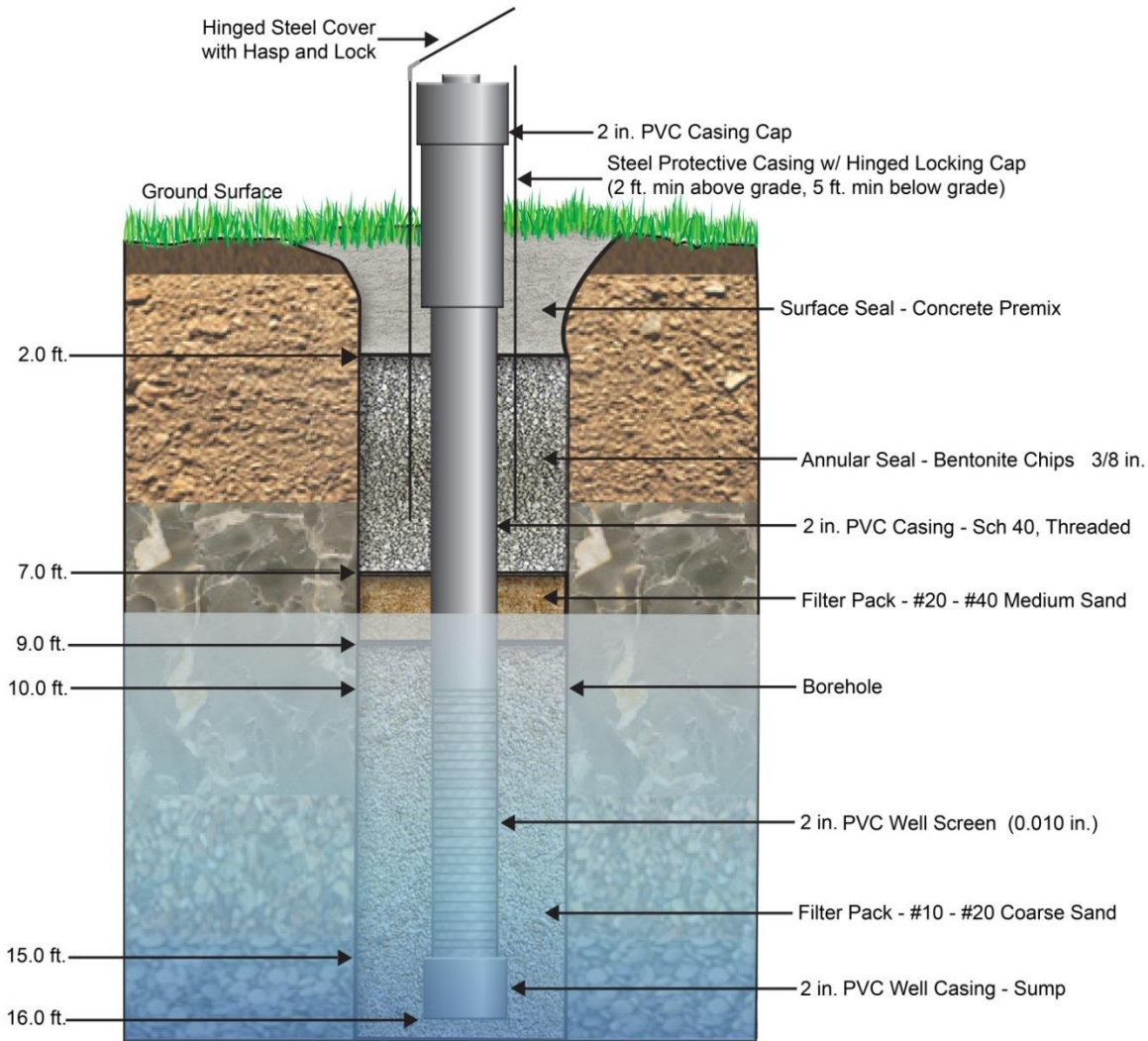

Figure 2-5. Permanent shallow ground water monitoring well design.

### 2.4.2.2 Temporary Monitoring Wells

Temporary monitoring wells are typically installed at the same time that test pits are excavated and evaluated. Monitoring wells are either placed in the excavated test pit or are placed in a separate hole near the test pit created by an auger. Temporary monitoring wells placed by an auger should be no farther than 10 feet from the evaluated test pit. More than one temporary monitoring well may be necessary at each site and is highly recommended. Each monitoring well should have an evaluated test pit associated with its placement.

Temporary monitoring wells are typically constructed of perforated or solid plastic pipe at least 1 inch in diameter. Solid plastic pipe should be manually perforated with holes or slits that extend up the pipe through the expected zone of saturation. Temporary monitoring wells should extend 10 feet belowground or to a known limiting layer less than 10 feet deep. Temporary monitoring wells placed to evaluate spring runoff influenced seasonal ground water should be extended above grade high enough to be found through snow pack during the early monitoring period. Removable caps are recommended to be placed on the top of each monitoring well. The bottom end of the monitoring well should not be capped. Geotextile fabric or a filter cloth/sock should be used to wrap the plastic pipe from the bottom of the pipe to a point above the perforations. Mound fill soil around the temporary monitoring well when backfilling the well excavation so a depression does not form in the ground’s surface around the mound that will collect surface runoff and artificially raise the ground water level within the monitoring well. An idealized temporary monitoring well for observing ground water of less than 18 feet deep is shown in Figure 2-6.

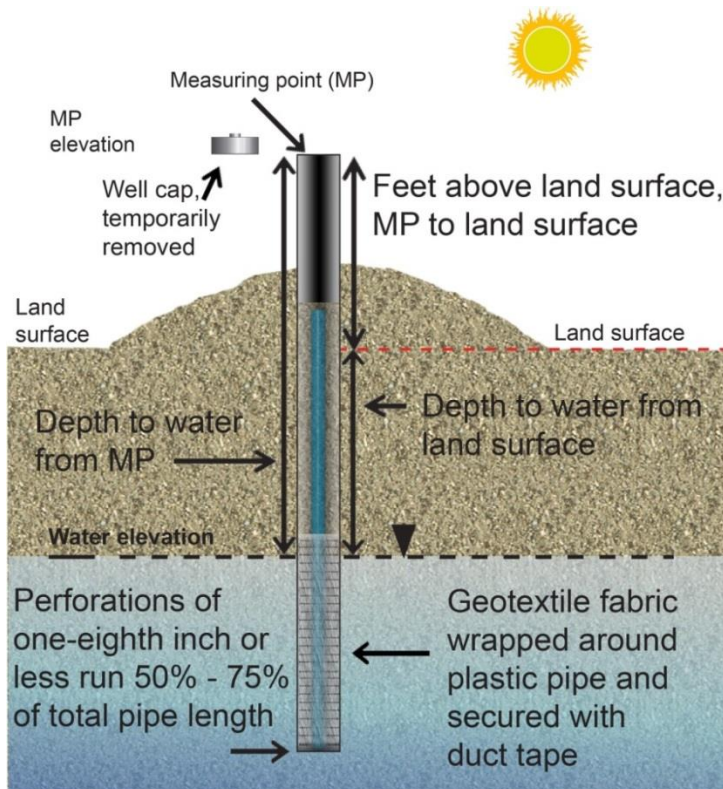

Figure 2-6. Temporary ground water monitoring well design.

### **2.4.2.3 Measuring the Seasonal Ground Water Level from a Monitoring Well**

Seasonal ground water is typically influenced by seasonal runoff of snowmelt, spring rain events, and irrigation practices. The time frame in which these influences affect a property may vary due to location, climate, or agricultural practices. Due to this variability, monitoring time frames required prior to subsurface sewage disposal permit issuance may vary from permit to permit. Monitoring periods may overlap if all of these influences are expected to impact seasonal ground water levels at a proposed subsurface sewage disposal site. Typical time frames for monitoring based upon ground water influences are as follows:

- Seasonal runoff and spring rain events: February 15 through June 30
- Irrigation: April 15 through October 31

Monitoring should be performed by the applicant on a weekly basis over the determined monitoring period. Concurrent monitoring at a proposed subsurface sewage disposal site should also be performed by the health district on a monthly basis to verify ground water levels obtained by the applicant. The monthly verification by the health district also allows for the evaluation of any potential temporary or intermittent surface waters that may exist on the site.

Prior to recording ground water levels from a newly installed permanent or temporary monitoring well, the well should be left undisturbed for 24 hours before observing and recording the ground water's surface elevation. To record the ground water level, mark a standardized location on the top rim of the monitoring well to obtain the ground water measurements from. Use the following equipment to obtain the ground water level below grade:

- Measuring tape that will fit inside the monitoring well
- Carpenter's chalk to coat the initial length of the measuring tape
- Ground water monitoring table that includes the following information:
  - Height of the monitoring well above the native soil surface
  - Total depth of the monitoring well from the top rim to its termination point below ground level
  - Date and time for each measurement
  - Location for recording the ground water level from top rim of monitoring well
  - Location for recording the total depth of wetted chalk (indicates how far below the ground water level that the measuring tape was inserted)
  - Location for recording the water level below ground surface (ground water level measurement minus the wetted chalk depth minus the height of the monitoring well above the native soil surface)
  - Location for date specific notes (e.g., weather, well conditions, and recorder)

The following steps should be taken at each monitoring well to obtain the ground water level:

1. Coat 1 to 2 feet of the measuring tape with carpenter's chalk.
2. Lower the measuring tape down the monitoring well with the tape against the identified measuring point on the top rim of the monitoring well. This step should occur at a rapid rate so the measuring tape can be heard when it encounters the top of the ground water level.

3. Once the tape has either encountered the top of the ground water level or the bottom of a dry monitoring well, record the value on the measuring tape that is identified at the measuring point on the top rim of the monitoring well.
4. Slowly remove the measuring tape from the monitoring well and obtain the total wetted chalk measurement.
5. Determine the ground water depth below native ground level by subtracting the wetted chalk measurement and height of the monitoring well above native ground from the measurement obtained in step 3.

Do not insert large diameter items into the ground water through the monitoring well to obtain ground water level measurements. Large items may cause water displacement and artificially raise the ground water level. Ground water monitoring should continue throughout or past the expected monitoring period until it is determined that the seasonal and normal high peaks have occurred and will not be exceeded.

**2.4.2.4 Determining Seasonal and Normal High Ground Water Levels**

Seasonal and normal high ground water levels can be determined once the weekly monitoring for the designated monitoring period is completed. The seasonal high ground water level is the weekly measurement that is the highest level recorded during the monitoring period. The highest level is the measurement that equates to the shallowest depth from the native ground level to the ground water level.

The normal high ground water level is the highest elevation of ground water that is maintained or exceeded for a continuous period of 6 weeks per year. This determination may include the seasonal high ground water level week but may fall outside of the seasonal high peak. If the determination of the normal high ground water falls outside of the seasonal high peak, it is because the highest ground water level that is maintained or exceeded for a continuous period of 6 weeks falls within this time frame (IDAPA 58.01.03.003.15.a). A normal high ground water level that falls in a 6-week block of time that does not include the seasonal high ground water level will be more restrictive than what would be determined by the 6-week block of time that included the seasonal high ground water level. The determination is demonstrated in Table 2-10 and Table 2-11.

**Table 2-10. Determination of seasonal ground water levels where the seasonal high ground water level and normal high ground water level occur within the same 6-week block of time.**

Monitoring Week	1	2	3	4	5	6	7	8	9
Ground water level (inches below native grade)	69	62	65	53	46	40	47	66	72

In Table 2-10, the seasonal high ground water level occurs within the 6-week block of time that defines the normal high ground water level. The seasonal high occurs in week 6 and is 40 inches below native grade. The 6-week block of time that defines the normal high ground water level occurs from week 2 through 7. During this time, the lowest ground water level recorded from native grade occurs on week 3, so the normal high ground water level is 65-inches below native grade.

**Table 2-11. Determination of seasonal ground water levels where the seasonal high ground water level occurs outside the 6-week block of time that determines the normal high ground water level.**

Monitoring Week	1	2	3	4	5	6	7	8	9
Ground water level (inches below native grade)	23	24	19	23	21	22	25	16	20

In Table 2-11, the seasonal high ground water level occurs outside of the 6-week block of time that defines the normal high ground water level. The seasonal high occurs in week 8 and is 16-inches below native grade. The 6-week block of time that defines the normal high ground water level occurs from week 1 through 6. During this time, the lowest ground water level recorded from native grade occurs on week 2, so the normal high ground water level is 24-inches below native grade. This level meets the requirements of IDAPA 58.01.03.003.15.a in that 24 inches is the highest elevation of ground water that is maintained or exceeded for a continuous period of 6 weeks.

### 2.4.3 Low Chroma Mottles

If the static ground water level cannot be determined through ground water monitoring due to the time of year the soil profile is observed, but its presence at some time in the year is suspected, its level can be predicted by looking for the presence of the following soil conditions:

1. Reddish-brown or brown soil horizons with gray mottles that have a chroma of two or less and red or yellowish-red mottles
2. Gray soil horizons that have a chroma of two or less, or gray soil horizons with red, yellowish-red, or brown mottles
3. Dark-colored, highly organic soil horizons
4. Soil profiles with soluble salt concentrations at or near the ground surface

Take care in interpreting soil conditions as an indicator of high ground water. Mottling may be the artifact of past ground water from geologic time. Some soils do not readily indicate mottling, especially those with high ferric (Fe<sup>+++</sup>) iron content and in areas with newly established water tables or where the brown color is from iron bacteria.

### 2.4.4 Historical Records

Historical records are another method that may be used to determine seasonal and normal high ground water levels for a proposed subsurface sewage disposal system. Use historical records that evaluate unconfined aquifers or perched seasonal water tables. Well drilling records may not be suitable in all circumstances and must be evaluated on a case-by-case basis if available. Historical records composed of ground water monitoring data, as described in section 2.4.2, should be used to determine ground water levels at a proposed site.

All historical records available for properties immediately surrounding the applicant’s property should be used to determine ground water levels. Other records from nearby properties should also be evaluated to gain an understanding of ground water levels for the immediate area with emphasis placed on records for properties closest to the applicant’s property. Take a conservative

approach in this evaluation, and use the most restrictive ground water level record within the historical records when issuing a permit.

#### **2.4.5 Low Water Years**

Take care when reviewing ground water monitoring records related to spring runoff during low water years. Snow-water equivalents of less than 75% of normal would be considered an extremely low water year. Ground water monitoring performed during these years may need to be repeated due to below normal ground water levels. Information regarding the snow-water equivalent reading is available through the Natural Resources Conservation Service.



## 2.5 Cutoff Trenches

Revision: July 18, 2013

### 2.5.1 Description

A cutoff trench is a perforated pipe installed beneath the ground surface that collects and conveys seasonal or normal high ground water to a natural drainage way.

### 2.5.2 Purpose and Function

Cutoff trenches may be used to lower seasonal high and normal high ground water on slopes by intercepting laterally moving ground water that is perched above a hydraulically restrictive horizon and directing the intercepted ground water away from the drainfield area. Cutoff trenches must intercept an impermeable layer for ground water to be significantly reduced in the area of the drainfield and replacement area (Figure 2-7).

Cutoff trenches that do not intercept impermeable layers will only reduce the water table in the near vicinity of the drainage trench. Drainage trenches do not significantly reduce the water table levels in the drainfield and reserve areas. Effectiveness of drainage trenches depends on site-specific criteria.

### 2.5.3 Approval Conditions

It is recommended that cutoff trenches are orientated parallel to the length and width of the drainfield and installed on all sides except for the downslope side as shown in Figure 2-8. The following conditions should be followed:

- Trenches must be keyed into the hydraulically restrictive zone, such as impermeable soil, or hardpan, at least 8 inches deep.
- Cutoff trenches may not be used to lower perched water tables in soils with moderate or strong platy structure and where the subsoil structure does not follow the topography of the land.
- Caution: Cutoff trenches must not pass through the confining layer. Cutoff trenches that pass through the confining layer could potentially drain a perched aquifer into a developed aquifer.
- Ground water levels must be monitored for an entire high ground water season after the cutoff trench is installed.
- Drainage must discharge to a natural drainage way on the property so the water will not flood or damage adjacent property.
- Cutoff trenches may not be used to drain wetlands.
- Cutoff trenches must meet surface water separation distances from upgradient drainfields.
- Cutoff trenches cannot be used for any large soil absorption system, community septic system, or central sewage system. Cutoff trenches may only be used for individual homes.
- Mechanical disposal of water is prohibited. Pumps are not allowed to be used with a cutoff trench.

- Slope of the site must be between 5% and 45%, and the minimum drain slope shall be 1% or 1 foot of fall per 100 feet of run.
- Outlets should be 50 feet from the property line unless discharging directly into a well-defined drainage way.
- Outlets shall be designed, constructed, located, and maintained in a manner that does not violate any applicable federal, state, or local laws or regulations.

Cutoff trench designed to intercept a laterally moving perched water table caused by a shallow, impermeable layer or hydraulically restrictive layer.

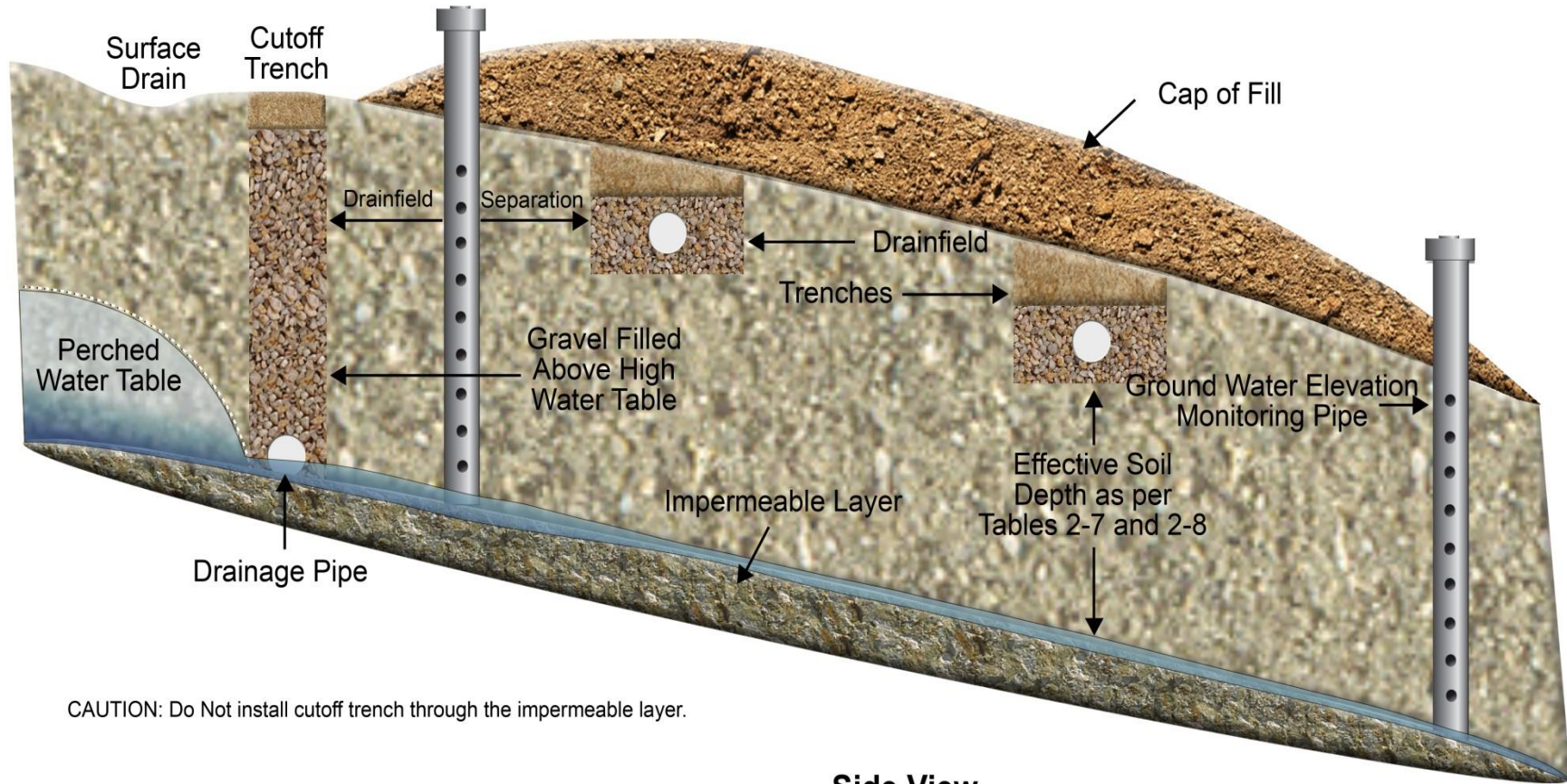

CAUTION: Do Not install cutoff trench through the impermeable layer.

Figure 2-7. Cutoff trench side view.

## Cut Off Trench Detail

Diversion Swale (Run-on Control)

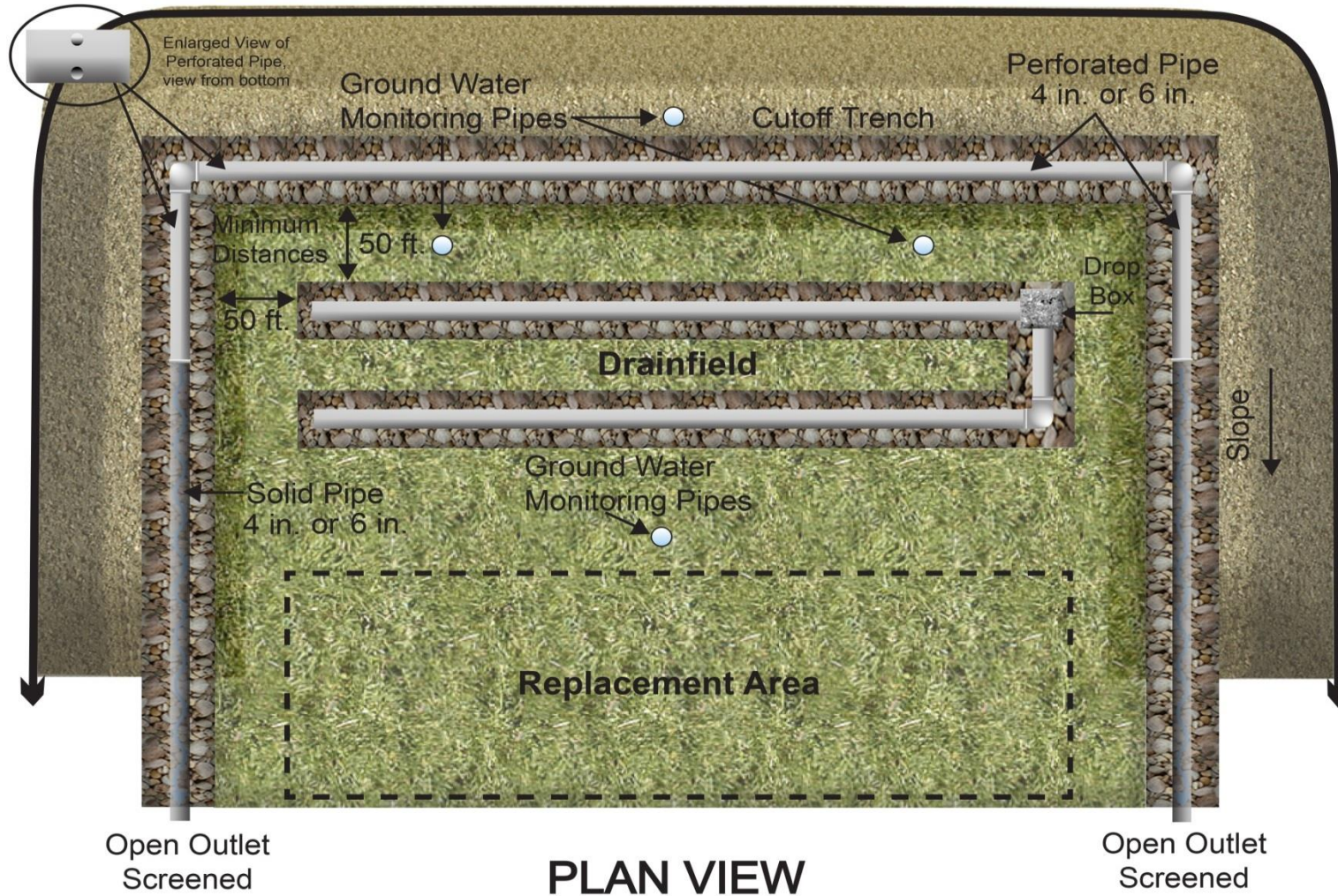

Figure 2-8. Cutoff trench plan view.

Table 2-12 shows drainfield setbacks from cutoff trenches based on percent slope. In Table 2-12, each split cell shows the drainfield depth requirement in the upper left and the minimum setback distance in the lower right. Effective soil depths for drainfields must meet requirements in Table 2-5 and Table 2-6.

**Table 2-12. Setbacks of drainfield from cutoff trench based on percent slope.**

Slope (%)	Depth of Cutoff Trench (feet)							
	3	4	5	6	7	8	9	10
5	0.5 - 3 50	1.5 - 4 50	2.5 - 4 50	3.5 - 4 50	4 61	4 81.5	4 100	4 120
10	0 - 3 30.5	0 - 4 40.5	0 - 4 50	1 - 4 50	2 - 4 50	3 - 4 50	4 50	4 61
15	0 - 3 18	0 - 4 25	0 - 4 32	0 - 4 39	0 - 4 45	0.5 - 4 50	1.5 - 4 50	2.5 - 4 50
20	0 - 3 14	0 - 4 19.5	0 - 4 24.5	0 - 4 29.5	0 - 4 34.5	0 - 4 39.5	0 - 4 44.5	0 - 4 50
25	0 - 3 11.5	0 - 4 16	0 - 4 19.5	0 - 4 23.5	0 - 4 27.5	0 - 4 31.5	0 - 4 35	0 - 4 39.5
30-45	0 - 3 9.5	0 - 4 13	0 - 4 16.5	0 - 4 19.5	0 - 4 23	0 - 4 26.5	0 - 4 30	0 - 4 33

Note: Split cells show drainfield installation depth requirements in the upper left and minimum setback distance in the lower right.

Each split cell in Table 2-12 shows the installation depth required to maintain the drainfield below the level of the cutoff trench. Drainfield setback distances are a function of slope. As the slope increases, the separation distance is reduced. The risk of septic tank effluent being intercepted by the cutoff trench decreases as the slope increases, which enables reduced setbacks at higher slopes.

### 2.5.4 Design and Construction Techniques

1. Excavate plumb sidewall of a 1-foot wide trench for the length of the cutoff trench, including side trench area. Trench depth depends on the depth to impermeable or hydraulically restrictive layers.
2. Install drain line (e.g., ultraviolet resistant pipe and foundation drain material). Drain holes are oriented down to intercept ground water at its lowest level. Cover and secure screen on the drain line outlet to prevent animal harborage and infestation. Use hardware cloth and a pipe clamp or animal guard (Figure 2-9). Minimum size of drain used in mains shall be determined by applying Manning’s equation, assuming full pipe flow. In no case shall the pipe be less than 4 inches in size, except when soils containing a high percentage of fine sand or where local experience has shown it to be desirable, the minimum size shall be 6 inches.
3. Cover drain line(s) with drainrock above the normal high ground water elevation.
4. Cover drainrock with a geotextile filter fabric of >1 ounce per square yard.
5. Fill trench with medium sand or pit run sand (4 inches minus) and cover with topsoil.
6. Construct diversion swale to prevent runoff from flowing onto the drainfield areas.
7. Excavate, or drill, and install ground water elevation monitoring pipes and monitor ground water elevation for an entire high ground water season to determine effectiveness of cutoff trenches.

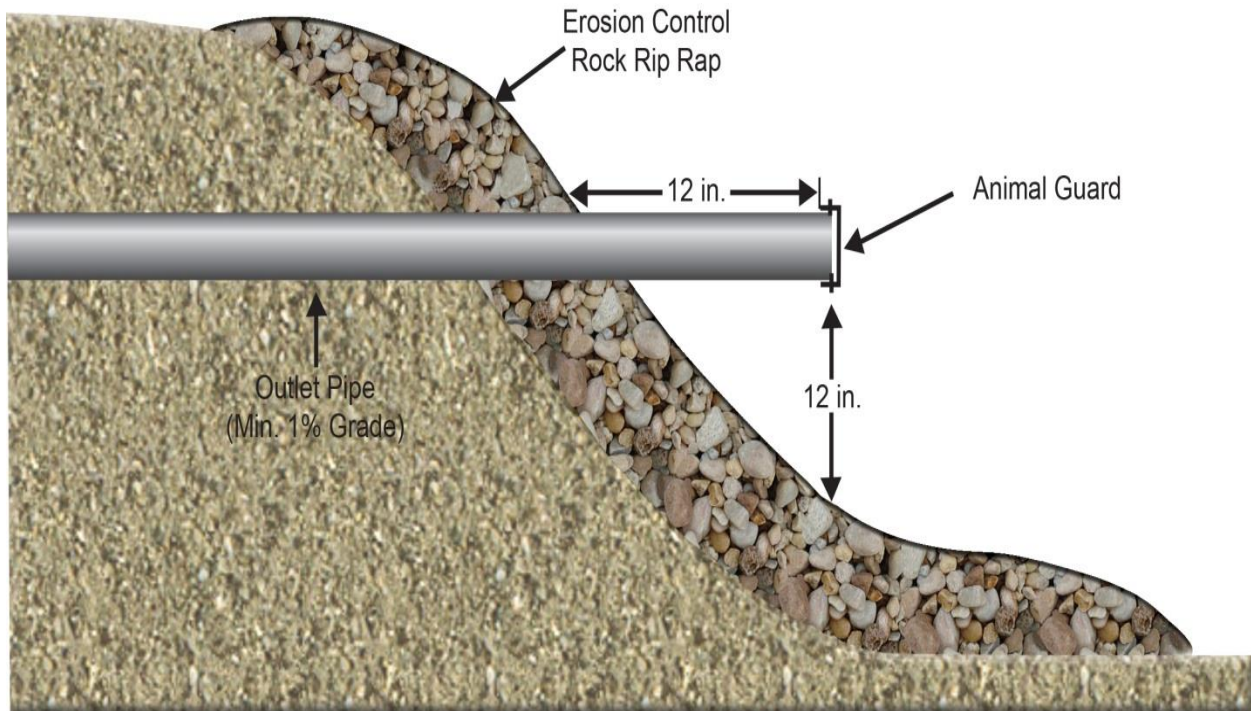

Figure 2-9. Cutoff trench outfall.

### **2.5.5 Maintenance**

1. Outlets should be kept clear of sediment and debris.
2. Erosion control practices shall be maintained, and outfall structures repaired to prevent scouring of sediment from the pipe outlets.
3. Animal guards shall be maintained to prevent rodent damage to the drain lines and obstruction of the pipe outlets.
4. Water-loving trees and shrubs should be kept at least 50 feet from all perforated drain lines.

## 2.6 Unstable Landforms

Revision: July 18, 2013

### 2.6.1 Description

Unstable landforms means areas showing evidence of mass downslope movement such as debris flow, landslides, rockfalls, and hummocky hill slopes with undrained depressions upslope (Table 2-13). Unstable landforms may exhibit slip surfaces roughly parallel to the hillside; landslide scars and curving debris ridges; fences, trees, and telephone poles that appear tilted; or tree trunks that bend uniformly as they enter the ground. Active sand dunes are unstable landforms. Figure 2-10 presents a cross section of an unstable landform.

**Table 2-13. Descriptions and characterizations of different unstable landforms.**

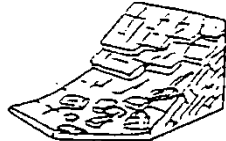
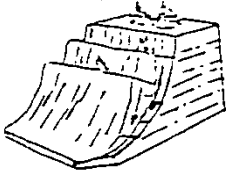
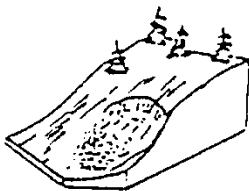
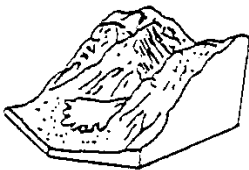
Process	Definition and Characteristics	Illustration
Rock fall and debris fall	The rapid descent of a rock mass, vertically from a cliff or by leaps down a slope. The chief means by which taluses are maintained.	
Rockslide and debris slide	The rapid, sliding descent of a rock mass down a slope. Commonly forms heaps and confused, irregular masses of rubble.	
Slump	The downward slipping of a coherent body of rock or regolith along a curved surface of the slumped mass, and any flat-lying planes in it, becomes rotated as it slides downward. The movement creates a sharp facing downslope.	
Debris flow	The rapid downslope plastic flow of a mass of debris. Commonly forms an apron- or tongue-like area, with an irregular surface. In some cases, begins with slump at head, and concentric ridges and transverse furrows in surface of the tongue-like part.	
Variety mudflow	A debris flow in which the consistency of the substance is that of mud; generally contains a large portion of fine particles, and a large amount of water.	



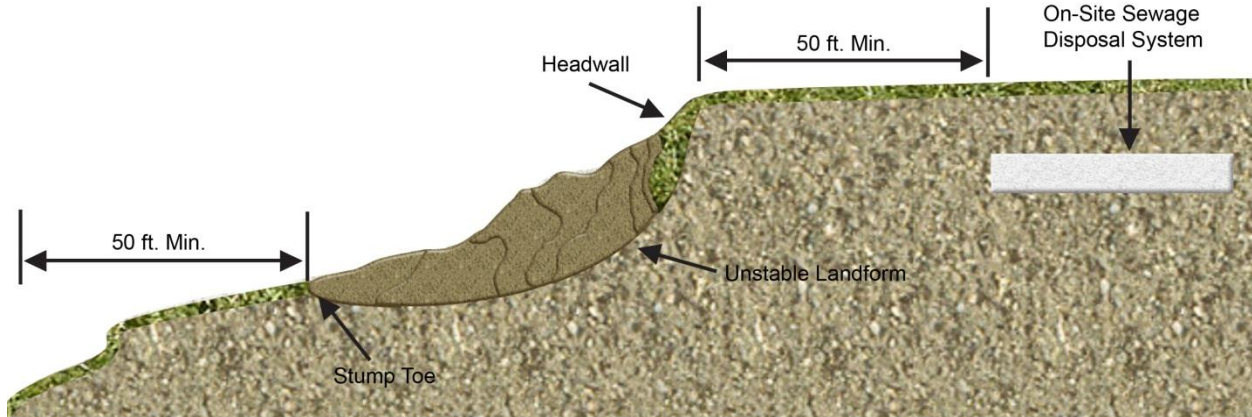

**Figure 2-10. Cross section of an unstable landform.**

### 2.6.2 Additional Application Information Requirement

Applicants proposing systems above a suspected unstable landform are required to provide supplemental information on the subsurface sewage disposal application as required in the “Individual/Subsurface Sewage Disposal Rules” (IDAPA 58.01.03.005.04.o) (section 7.1). The septic tank and drainfield shall not be installed on an unstable landform, where operation of the subsurface sewage disposal system may be adversely affected or where effluent discharged to the subsurface will contribute to the unstable nature of the downslope landform.

A permit shall be denied for a subsurface sewage disposal system application where any portion of the system must be installed on an unstable landform. Locating subsurface sewage disposal systems on unstable landforms will result in adverse system operation, performance, and effluent treatment.

*This page intentionally left blank for correct double-sided printing.*

### 3 Standard Subsurface Disposal System Design

#### 3.1 Dimensional Requirements

Revision: July 18, 2013

Figure 3-1 shows the major horizontal separation distance requirements for a standard drainfield. Figure 3-2 shows the major horizontal separation distance requirements for a septic tank.

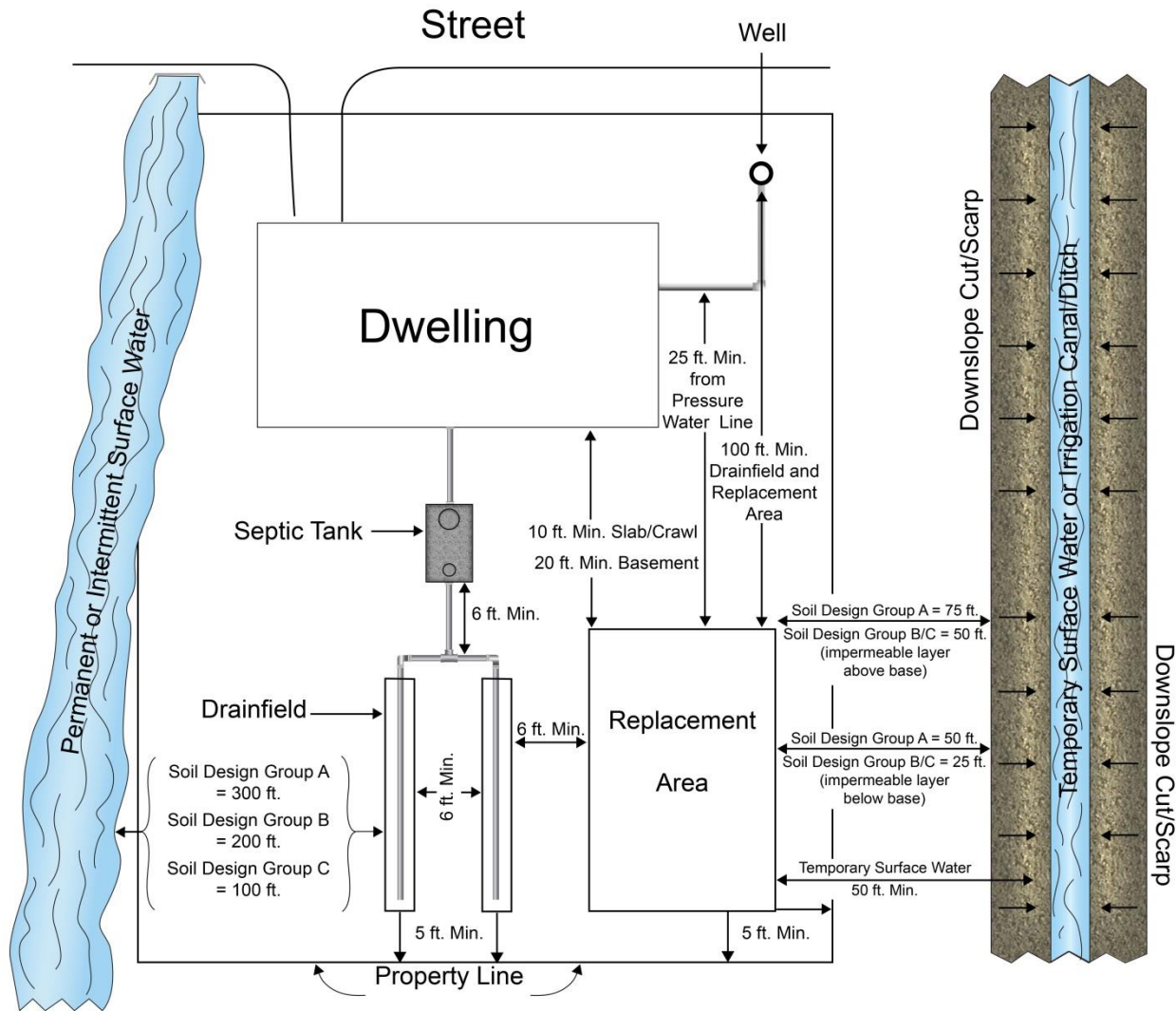

Figure 3-1. Horizontal separation distance requirements for a standard drainfield (IDAPA 58.01.03.008.02.d and 58.01.03.008.04).

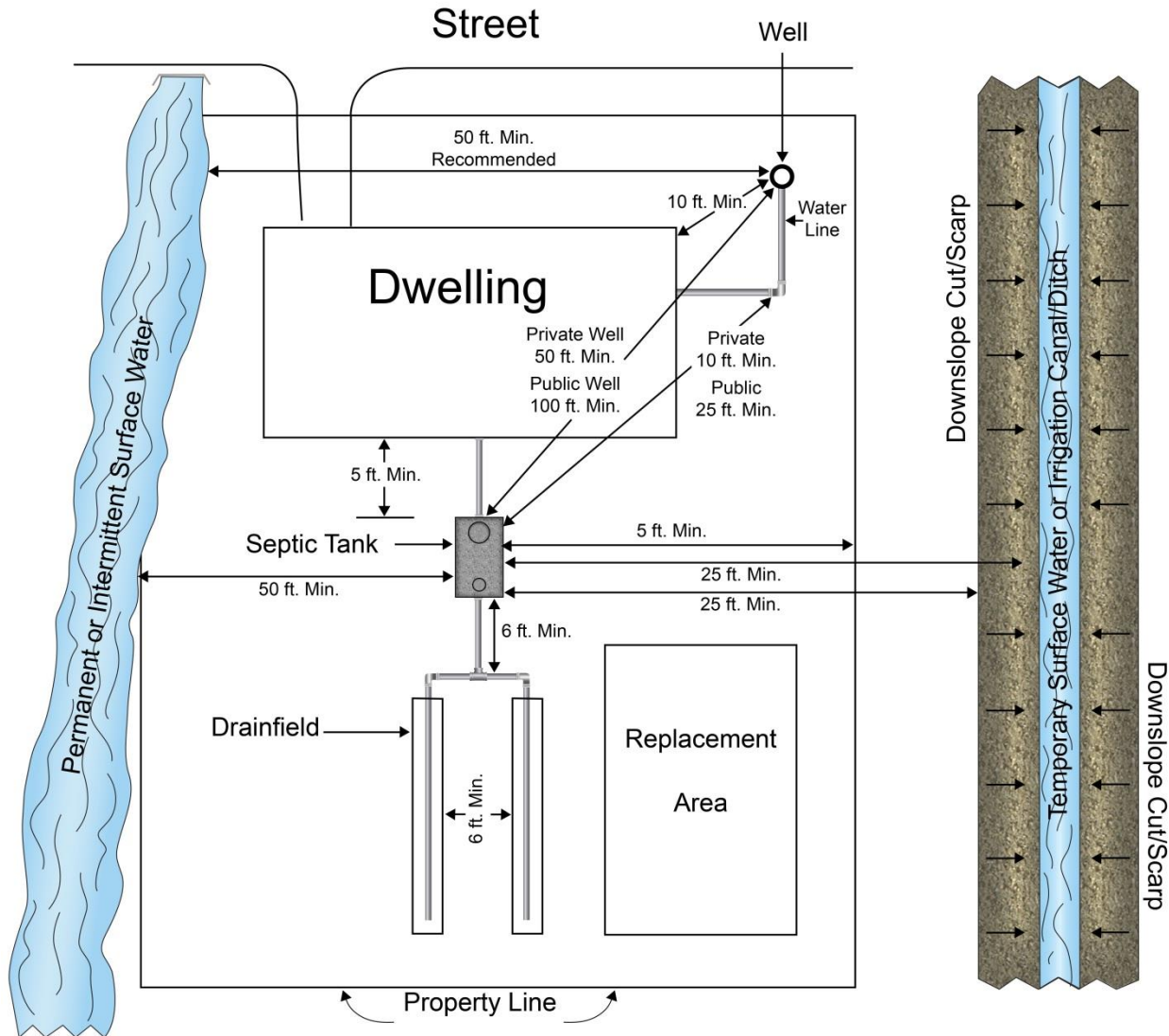
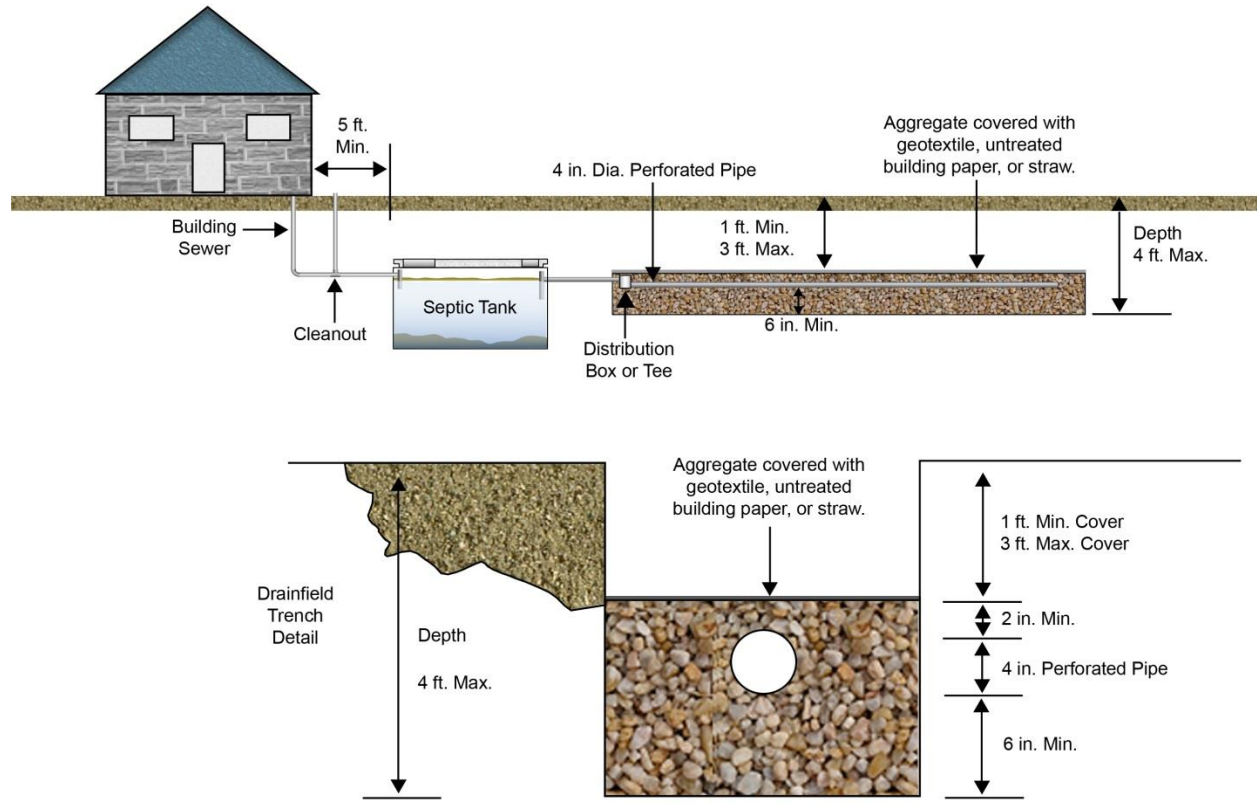

Figure 3-2. Horizontal separation distance requirements for a septic tank (IDAPA 58.01.03.007.17).

1. Minimum separation distance of 20 feet is required between a drainfield and a dwelling with a basement (IDAPA 58.01.03.008.02.d). If the basement is a daylight-style basement and the drainfield installation is below the daylight portion of the basement the minimum separation distance can be reduced to 10 feet.
2. Minimum separation distance of 6 feet is required between absorption trenches and from installed trenches or beds to the replacement area. Separation distance must be through undisturbed soils (IDAPA 58.01.03.008.04).
3. Minimum separation distance of 6 feet is required between the septic tank and the drainfield. Separation distance must be through undisturbed soils (IDAPA 58.01.03.008.04).
4. Minimum separation distance of 50 feet is required between an effluent line and a septic tank to a domestic well (IDAPA 58.01.03.007.17 and 58.01.03.007.22).

Figure 3-3 shows a cross-sectional view of a standard drainfield, along with trench dimensional installation requirements.



**Figure 3-3. Cross-sectional view of a standard drainfield and trench dimensional installation requirements.**

## 3.2 Components of Standard Systems

Revision: May 6, 2020

### 3.2.1 Interceptors (Clarifiers) and Grease Traps

Interceptors (clarifiers) and grease traps are specifically designed devices installed to separate and retain materials, such as greases and oils, from sewage. They are usually installed between the discharging fixture, such as a sink or slaughter pad, and the septic tank. Interceptor (clarifiers) and grease trap volumes are not substitutes for minimum septic tank capacities.

Design and installation of these devices is under the jurisdiction of the Idaho Division of Building Safety, Plumbing Bureau, or a local administrative authority. These devices or additional pretreatment devices may be required for commercial or industrial establishments, such as food service businesses, car washes, slaughter houses, or others who discharge substances in the wastewater that would be detrimental to the sewage disposal system. Pretreatment device effectiveness is substantiated by monitoring the effluent and reporting the operation and maintenance performed.

Any person applying to discharge nondomestic wastewater to a subsurface sewage disposal system shall be required to provide wastewater strength characterization and sufficient information to the Director, documenting that the wastewater will not adversely affect the waters of Idaho. Commercial establishments with wastewater strengths exceeding normal domestic wastewater strength, as depicted in Table 3-1, are required to pretreat the wastewater down to normal domestic wastewater strengths.

Information on these devices is found in the Uniform Plumbing Code, 2000 Edition, Chapter 10 and Appendix H. Plans and specifications for these devices must be approved by the Idaho Division of Building Safety-Plumbing Bureau, or local administrative plumbing authority.

**Table 3-1. Constituent mass loadings and concentrations in typical residential wastewater.<sup>a</sup>**

Constituent	Parameter	
	Mass Loading (grams/person/day)	Concentration (mg/L) <sup>b</sup>
Total solids (TS)	115–200	500–880
Volatile solids	65–85	280–375
Total suspended solids (TSS)	35–75	155–330
Volatile suspended solids	25–60	110–265
Five-day biological oxygen demand (BOD5)	35–65	155–286
Chemical oxygen demand (COD)	115–150	500–660
Total nitrogen (TN)	6–17	26–75
Ammonia (NH4+)	1–3	4–13
Nitrite (NO2-N) and nitrate (NO3)	<1	<1
Total phosphorus (TP)	1–2	6–12
Fats, oil, and grease	12–18	70–105
Volatile organic compounds (VOC)	0.02–0.07	0.1–0.3

Constituent	Parameter	
	Mass Loading (grams/person/day)	Concentration (mg/L) <sup>b</sup>
Surfactants	2–4	9–18
Total coliforms (TC) <sup>c</sup>	—	108–1010
Fecal coliforms (FC) <sup>c</sup>	—	106–108

Source: United States Environmental Protection Agency, *Onsite Wastewater Treatment and Disposal Systems Manual, 2002, (EPA/625R-00-008), Table 3-7, page 3-11.*

- a. For typical residential dwellings equipped with standard water-using fixtures and appliances.
- b. Milligrams per liter (mg/L); assumed water use of 60 gallons/person/day (227 liters/person/day).
- c. Concentrations presented in Most Probable Number (MPN) of organisms per 100 milliliters.

### 3.2.2 Building Sewer

The design and installation of a building sewer is under the jurisdiction of the Idaho Division of Building Safety-Plumbing Bureau, or a local administrative authority. The state or local authority must approve any plans involving the construction or installation of a building sewer. Contact the Plumbing Bureau for all guidance, permitting, and inspection requirements related to the building sewer components from household fixtures up to the inlet of the septic tank.

Information provided here is advisory only and intended for planning purposes.

1. Building sewers must run at a uniform slope of not less than 0.25 inches per foot toward the point of discharge.
2. Building sewer piping should be laid on a firm, stable bed throughout its entire length.
3. Building sewers must be installed a minimum of 12 inches below the surface of the finished grade.
4. Cleanouts shall be placed:
  - a. Inside the building near the connection between the building drain and building sewer, or
  - b. Outside the building at the lower end of a building drain and extended to grade, and
  - c. At intervals of up to 100 feet in straight runs, and
  - d. At every change in alignment or grade in excess of 22.5 degrees, except that no cleanout will be required for one 45 degree change of direction or one 45 degree offset.

### 3.2.3 Septic Tank and Dosing Chamber Installation

*Septic tanks and dosing chambers may not be modified from their approved design (e.g., core drilling and roto-hammer) without prior approval from DEQ, which must be obtained through a manufacturer’s submittal as described in section 1.4.2.1.1 detailing the proposed structural changes.*

Septic tanks and dosing chambers shall be installed level and should be placed on undisturbed original soil if possible. Some fill is often needed to make a smooth bearing surface in the bottom of the excavation that will receive the tank or chamber. A tank or chamber should not be installed on unconsolidated or uncompacted fill greater than 6 inches deep. If fill material greater than 6 inches deep is necessary to level the installation surface, it should be compacted to 95%

proctor to mitigate potential settling issues. All plastic, polyethylene, and fiberglass tanks must be installed according to the manufacturer's recommendations including required bedding material for the tank excavation (IDAPA 58.01.03.007.18).

Concrete tanks or chambers may leak if they are not coated with a bituminous coating or another sealer. Such sealing is recommended in all dosing chambers and septic tanks placed in or near ground water or in porous soils. The sealant should cover all of the tank walls and tank bottom. The sealant may be placed on the inside or outside of the septic tank. If located on the inside of the tank, the sealant should be compatible with sewage. If located outside of the tank, the required manufacturer labeling must still be legible for the inlet and outlet, manufacturer's name or trademark, or the liquid capacity of the tank somewhere on the tank body or tank lid.

If a septic tank or dosing chamber is installed in seasonal high ground water, a vertical separation distance of 2 feet shall be met from the tank lid (IDAPA 58.01.03.007.17). Monolithically constructed tanks (one-piece tanks) are highly recommended to be used if the tank is to be installed in seasonal high ground water. Multipiece tanks should be avoided for ground water installations if possible. If a multipiece tank is installed in ground water, the vertical separation distance shall be to the top of the tank. Multipiece tanks installed in ground water shall be leak tested upon installation.

All septic tanks must have a riser if the manhole opening of the tank is deeper than 24 inches below the ground surface. The riser must bring the access lid within 18 inches of the ground surface (IDAPA 58.01.03.007.19). It is highly recommended that all tank access lids be brought to grade with a riser and fitted with a secured lid regardless of the tank's installation depth. It is also recommended that the riser is attached and sealed to the septic tank to prevent water infiltration. All dosing chambers must have the access manholes extended to the ground surface regardless of the chamber's installation depth.

ABS schedule 40 or equivalent is recommended to span the tank excavation or to connect septic tanks to dosing chambers or other septic tanks in a series (IDAPA 58.01.03.007.21). The pipe used to span septic tank and dosing chamber excavations must also extend at least 3 feet beyond the excavation (IDAPA 58.01.03.007.21). Thinner-walled ASTM D3034 plastic pipe may be used for these applications if the excavation void at the tank's sides is compacted with fill material (IDAPA 58.01.03.007.21.b). The material must be granular, clean, and compacted to 90% proctor density. The ASTM D3034 grade of plastic pipe is also suitable if it is placed on undisturbed earth. See IDAPA 58.01.03.007.21 for inlet and outlet piping requirements.

After installation, septic tanks and dosing chambers require periodic inspection and maintenance. Inspection and maintenance of these tanks is easier if the manhole access lids are brought to grade as described above. Minimum maintenance includes periodic pumping of the tank. Other maintenance may include cleaning the septic tank effluent filter (section 5.8) or cleaning the pump screen in the dosing chamber. All materials washed from a filter or screen should be discharged into the inlet side of the septic tank. Also periodically inspect the inlet and outlet baffle of the septic tank, or perform maintenance on the baffles as needed.

Occasionally, a septic tank may be abandoned due to age, condition, or replacement. Septic tank abandonment may also be required if in the Director's opinion (see IDAPA 58.01.03.003.10 for definition), the abandonment (IDAPA 58.01.03.003.01) is necessary to protect the public's



health and safety from eventual collapse of the septic tank or misuse. The abandonment of a septic tank or dosing chamber, if necessary, must be done according to the following requirements (IDAPA 58.01.03.007.23):

1. Disconnecting the inlet and outlet piping.
2. Pumping the scum and septage using a permitted pumper with an approved disposal location.
3. Filling the septic tank with earthen materials, or
4. Physically destroy or removing the septic tank from the ground.

### ***Septic Tank to Lift Station Conversion***

In some circumstances, an existing subsurface sewage disposal system drainfield may have been installed deeper than the currently allowed maximum installation depth for a subsurface sewage disposal system. Upon repair or replacement of the existing system, it may be necessary to raise the discharge point elevation of the effluent to meet the current installation depth standards for the drainfield. The following recommendations should be met when choosing a method to accomplish this action:

1. Lifting effluent prior to the drainfield may be done in one of two ways:
  - a. Installation of a septic tank or dosing chamber after the existing septic tank.
    - 1) The septic tank or dosing chamber must have an approved bury depth meeting the depth of the existing septic tank.
    - 2) A pump must be installed, meeting the requirements in section 4.19, in the new septic tank or dosing chamber to lift the effluent to the maximum drainfield installation depth.
  - b. Conversion of the existing septic tank into a lift station to raise the effluent into a newly installed septic tank that is capable of gravity flow to the maximum drainfield installation depth.
2. Either of the methods listed in item 1 are allowable, but the recommended method is the installation of a septic tank or dosing chamber after the existing septic tank (oversized risers are recommended for access to these tanks). This is due to the following reasons:
  - a. The wastewater undergoes primary treatment (clarification in the septic tank) prior to passing through a pump.
  - b. Wastewater that has not undergone primary treatment prior to pumping does not settle out in the septic tank as well once it has passed through a pump.
  - c. Less solids, fats, oils, and greases associated with wastewater are passed to the drainfield if the wastewater undergoes primary treatment prior to passing through a pump.
3. If an applicant or installer elects to convert an existing septic tank into a lift station instead of installing a septic tank or dosing chamber after the existing septic tank, the following should be taken into consideration:
  - a. The conversion of the septic tank into a lift station must be done under a permit from the Idaho Division of Building Safety Plumbing Program and Electrical Program.

- 1) The Plumbing Program inspects everything from the converted lift station up to the newly installed septic tank.
- 2) The Electrical Program inspects all electrical connections and installation associated with the lift station pump.
- 3) A subsurface sewage disposal installer's registration permit is not a substitute for a proper plumbing or electrical license.
- b. The Idaho State Plumbing Code allows a lift station to discharge the entire volume of the lift station when the pump turns on.
  - 1) This will cause the entire volume of the lift station to discharge to the new septic tank with each pump cycle if the pump control floats are not adjusted.
  - 2) It is recommended that lift station pump control floats be adjusted to discharge a maximum of 25% of the daily design flow of the subsurface sewage disposal system with each pump cycle.
4. It is also important that the applicant and installer protect the drainfield to the best of their ability if a lift station is installed prior to a septic tank. The following minimum recommendations may help achieve this goal:
  - a. An effluent filter may be installed in the outlet baffle of the new septic tank and the outlet manhole brought to grade through the installation of a lid riser to aid in effluent filter maintenance.
  - b. The septic tank may be oversized by a 1-day system design flow to increase retention and settling time of the wastewater in the septic tank prior to discharge to the drainfield.
  - c. A two-compartment septic tank may be installed to aid in settling of the wastewater in the septic tank prior to discharge to the drainfield.
  - d. The pump used in the lift station may be capable of passing larger solids (not larger than the transport piping from the lift station to the septic tank) and grinder-type pumps are not recommended.

### 3.2.4 Drainfields

Whether it is a trench or a bed, the drainfield should not be constructed when the soil is near or wetter than its optimum moisture (IDAPA 58.01.03.008.06). At optimum moisture, soil will compact to its maximum ability and thus reduce its capability to transmit water. This ability to compact and restrict flow is particularly true of finer soils, such as silt loams and clay loams. It is not as critical in sands or sandy loams.

If it is entirely unavoidable to excavate the drainfield when the soil is wetter than its optimum moisture content, then the trench sidewalls and trench bottom in the excavated drainfield should be raked to relieve any compaction. Backhoe buckets and teeth can effectively smear both trench sidewalls and trench bottoms. Therefore, raking should be done manually with a strong iron garden rake after all excavation with a backhoe is complete and before the drainrock is put in place.

Drainrock should be checked for cleanliness before it is placed in the trenches. Long transportation time may generate additional fines. If drainrock is found to be unsuitably dirty

when it arrives at the site, it can often be cleaned in the truck by tipping the truck bed slightly and washing the rock with a strong stream of water.

Trenches do not have to be constructed straight. It is always preferable to follow the contour of the land. The drainfield must not be installed in floodways, at slope bases, in concave slopes, or depressions. Drainfield areas shall be constructed to allow for surface drainage and to prevent ponding of water over the drainfield.

Table 3-2 gives the lengths of trenches in the seven soil subgroups (A-2 has two application rates; see section 2.1.2, Table 2-4).

Drainfields larger than 1,500 ft<sup>2</sup> trench area bottom are prohibited from being constructed as a standard (gravity) drainfield (IDAPA 58.01.03.008.04). Drainfields exceeding 1,500 ft<sup>2</sup> in total trench bottom area must be pressure-dosed (section 4.19).

**Table 3-2. Area requirements and total trench lengths for standard subsurface sewage disposal systems.**

<b>Number of Bedrooms</b>	<b>1</b>	<b>2</b>	<b>3</b>	<b>4</b>	<b>5</b>	<b>6</b>
<b>Gallons per day</b>	<b>150</b>	<b>200</b>	<b>250</b>	<b>300</b>	<b>350</b>	<b>400</b>
<b>Total Trench Lengths (feet)</b>						
<i>Soil Group A-1 total feet</i>	125	167	208	250	292	333
3-ft wide trench	42	56	69	83	97	111
2.5-ft wide trench	50	67	83	100	117	133
2-ft wide trench	63	83	104	125	146	167
<i>Soil Group A-2a total feet</i>	150	200	250	300	350	400
3-ft wide trench	50	67	83	100	117	133
2.5-ft wide trench	60	80	100	120	140	160
2-ft wide trench	75	100	125	150	175	200
<i>Soil Group A-2b total feet</i>	200	267	333	400	467	533
3-ft wide trench	67	89	111	133	156	178
2.5-ft wide trench	80	107	133	160	187	213
2-ft wide trench	100	133	167	200	233	267
<i>Soil Group B-1 total feet</i>	250	333	417	500	583	667
3-ft wide trench	83	111	139	167	194	222
2.5-ft wide trench	100	133	167	200	233	267
2-ft wide trench	125	167	208	250	292	333
<i>Soil Group B-2 total feet</i>	333	444	556	667	778	889
3-ft wide trench	111	148	185	222	259	296
2.5-ft wide trench	133	178	222	267	311	356
2-ft wide trench	167	222	278	333	389	444
<i>Soil Group C-1 total feet</i>	500	667	833	1,000	1,167	1,333
3-ft wide trench	167	222	278	333	389	444
2.5-ft wide trench	200	267	333	400	467	534
2-ft wide trench	250	333	417	500	548	667
<i>Soil Group C-2 total feet</i>	750	1,000	1,250	1,500	1,750	2,000
3-ft wide trench	250	333	417	500	a	a
2.5-ft wide trench	300	400	500	600	a	a
2-ft wide trench	375	500	625	750	a	a

a. Exceeds 1,500 square feet of total trench area. Use an alternative system to reduce the installed square footage of

trench area below 1,500 square feet or install a pressure-dosed system.

### 3.2.5 Equal Distribution

In equal distribution, wastewater effluent is distributed to all trenches within the subsurface sewage disposal system, which provides the opportunity to use the entire infiltrative surface of the disposal system. Equal distribution is the preferred method of wastewater discharge to any subsurface sewage disposal system on a flat or slightly sloped site. The best way to accomplish equal distribution is through drainfield pressurization (section 4.19). When gravity flow is used for wastewater discharge to the subsurface system, equal distribution to each subsurface sewage disposal trench can be accomplished by using a piping header or distribution box.

#### 3.2.5.1 Piping Header

With a piping header system, wastewater is conveyed to each disposal trench using a network of solid piping. The discharge line from the septic tank should be split using a T-pipe fitting. The T-pipe should be offset equally from the distribution trenches. One-directional sweeping cleanouts should not be used in place of a bidirectional T-pipe. Install the T-pipe fitting on a solid surface in a level position. DEQ recommends that the piping header only be used in installations involving two trenches. Figure 3-4 shows an overhead view of this distribution setup.

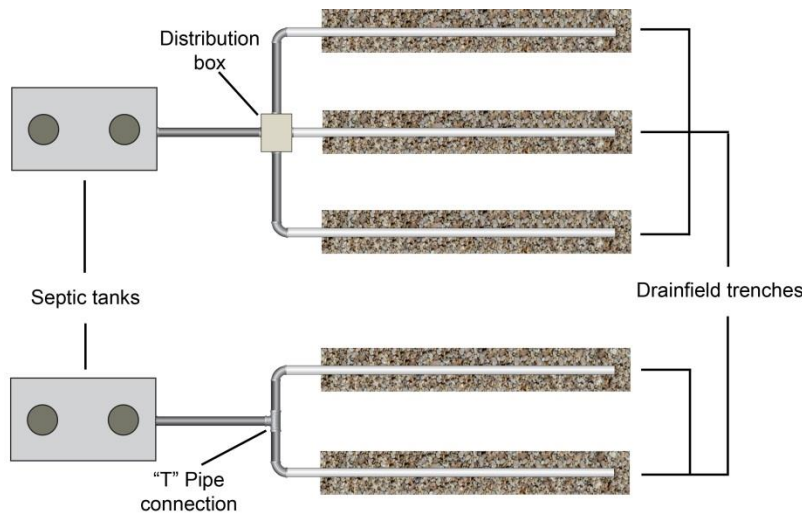

Figure 3-4. Overhead view of equal distribution methods for level sites.

#### 3.2.5.2 Distribution Box

Distribution boxes (d-boxes) are used to divide wastewater effluent evenly among multiple subsurface distribution lines. The d-boxes are typically made of concrete or wastewater-grade plastics and are watertight with a single inlet set at a higher elevation in the d-box than the outlets. Outlets should be constructed at equal elevations to one another. The d-box should be constructed with an access lid. Access lids are recommended to be made accessible from grade. Install the d-box level and on sound footing (e.g., properly bedded to prevent settling and heaving).

Several leveling devices are available for installation on the distribution lines that leave the d-box to ensure each line receives equal amounts of effluent if the piping or d-box becomes unlevel. During initial installation, DEQ recommends installing leveling devices on the effluent lines leaving the distribution box. Distribution boxes are highly recommended for situations when more than two trenches are installed and gravity flow is desired. Figure 3-4 provides an overhead view of this distribution setup on a level site. Figure 3-5 provides an overhead view of a distribution box setup on a sloped site.

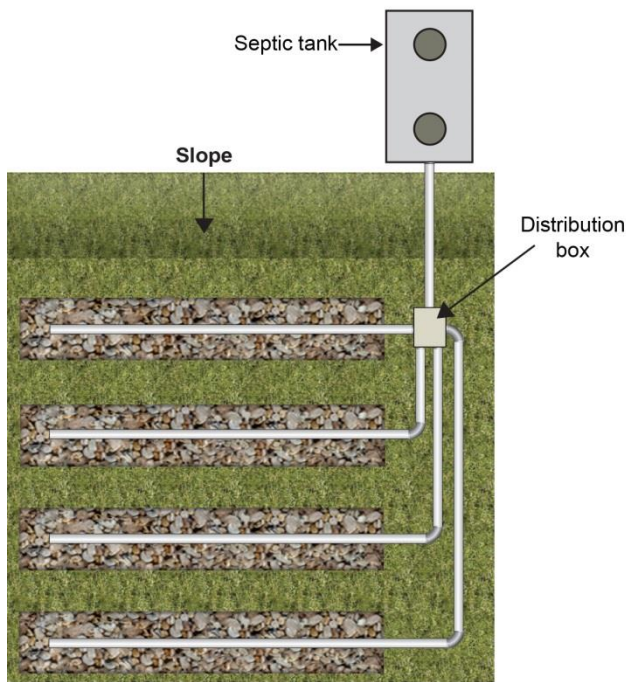

Figure 3-5. Overhead view of a distribution box layout on a sloped site.

### 3.2.6 Serial Distribution

Serial distribution allows each trench to load and completely flood with effluent before effluent flows to the next trench in series. Serial distribution is typically used on sites with slopes in excess of 20%. With this distribution method, trenches do not need to be constructed at the same length, but each trench must maintain a level installation by following an elevation contour. Serial distribution is accomplished either by installing relief lines or drop boxes between successive trenches. DEQ strongly recommends that serial distribution be accomplished by using drop boxes due to control and access aspects of the system design.

#### 3.2.6.1 Relief Lines

Relief lines are overflow lines that connect one trench to the adjacent lower trench in series. Relief lines are constructed of solid-wall piping and may be placed at opposite ends of successive trenches or anywhere within the trench line. If relief lines are installed in the middle of trenches, successive relief lines should be offset by a minimum of 5 feet to avoid short-circuiting the distribution system. Exercise care in excavating the relief line between trenches. Bleeding of effluent down this excavation is a common cause of surfacing effluent in serial distribution systems. The excavation of the connecting trench to the next downslope trench

should be just deep enough to accept the solid connector pipe. Figure 3-6 shows for an overhead view of a relief line installation system network. Figure 3-7 shows a cutaway view of relief line connections between trenches.

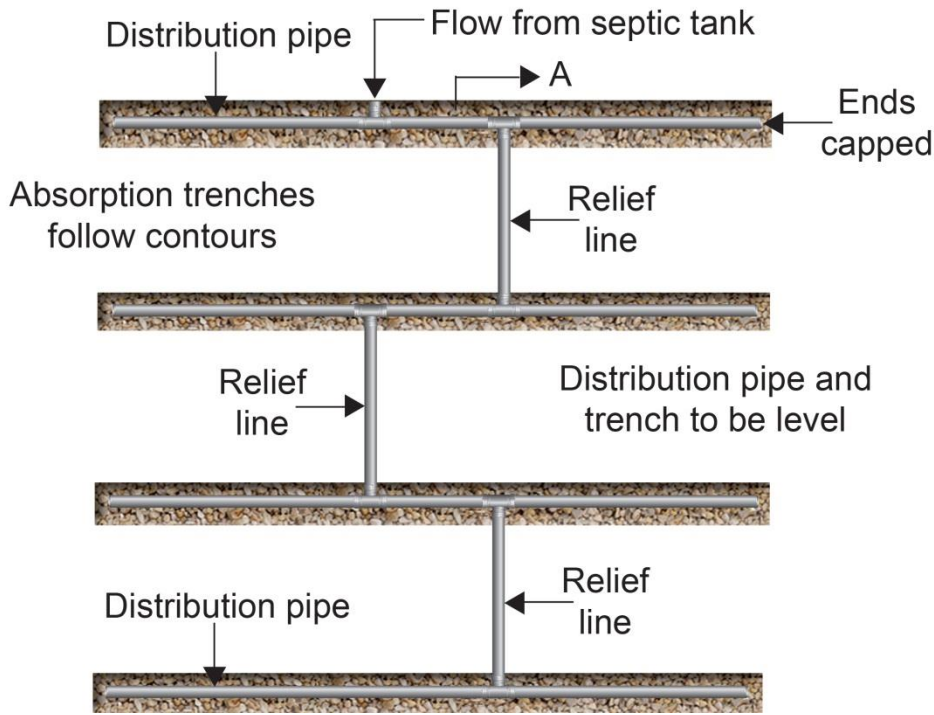

Figure 3-6. Overhead view of a relief line system network.

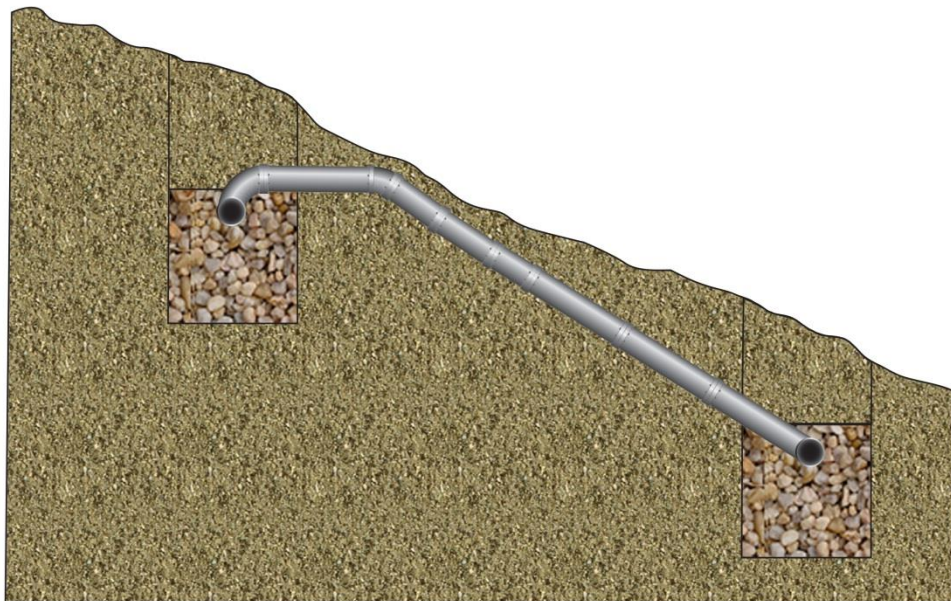

Figure 3-7. Side view of relief line installation between trenches.

### 3.2.6.2 Drop Boxes

Serial distribution may also be accomplished through the use of drop boxes. This method is commonly referred to as sequential distribution. Distribution boxes should not be substituted for drop boxes in this system design. The drop boxes are constructed so that each trench is completely flooded before the effluent flow runs to the next downslope trench in series. The drop box consists of an inlet from the septic tank or uphill drop box and an outlet to the downhill drop box offset roughly 1 inch from the invert of the inlet from the septic tank or uphill drop box to the invert of the outlet to the downhill drop box. There are an additional two outlets to the drainfield trenches at the same height that should be a minimum of 2 inches from the invert of the outlet to the next drop box to the top of the outlet ports for the drainfield trenches at this location. The trench outlets from the drop box should be set level with the distribution pipes in the disposal trench connected to the drop box. Use a solid-wall pipe between drop boxes. Figure 3-8 shows the detail of a drop box and the associated distribution system. Figure 3-9 shows an overhead view of a drop box installation using multiple trenches with one drop box.

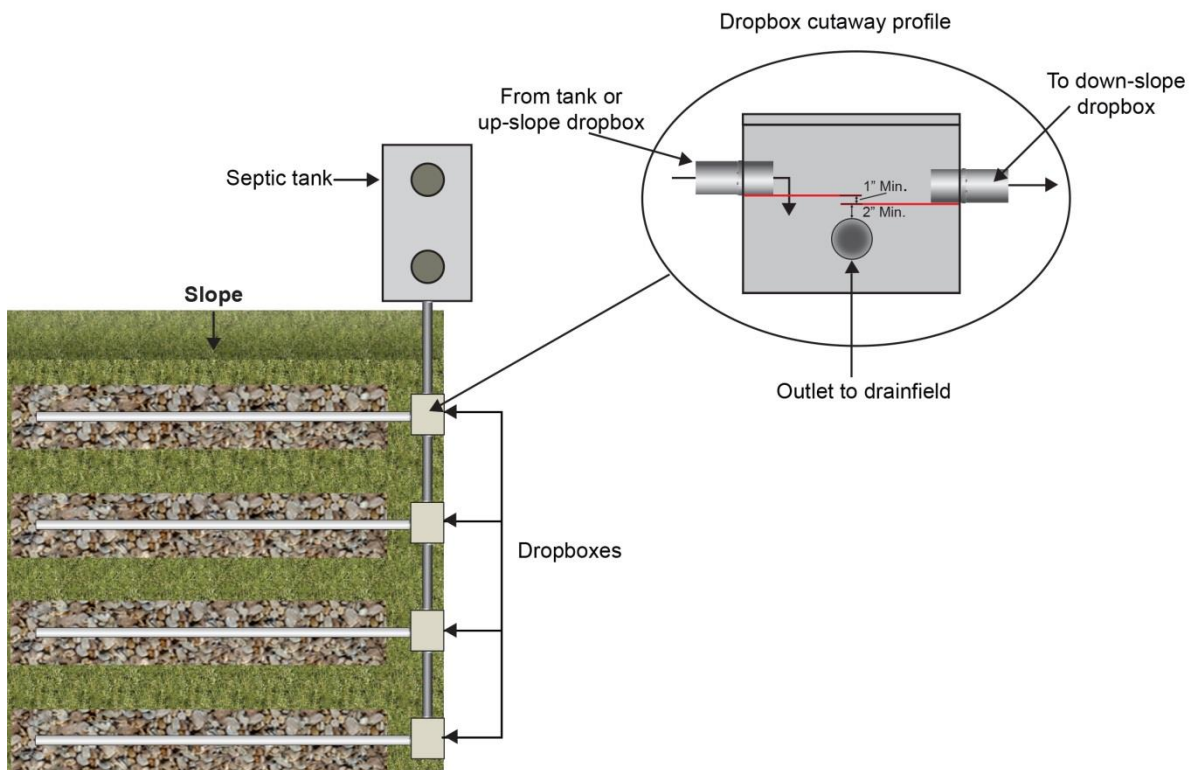
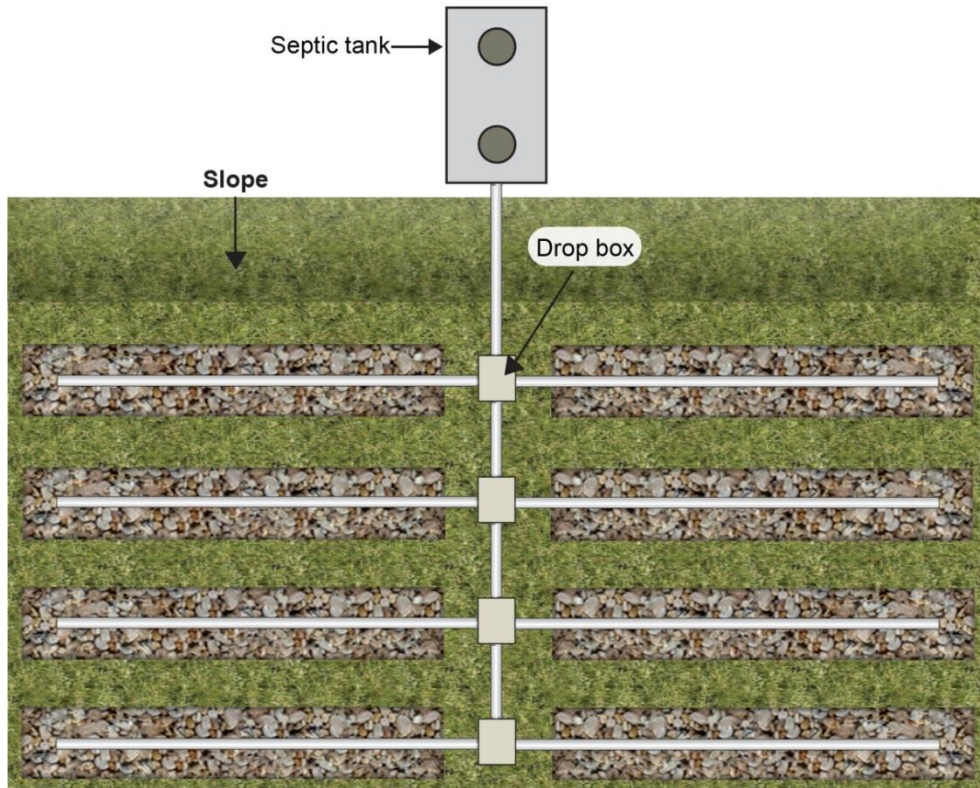

Figure 3-8. Drop box and sequential distribution details.



**Figure 3-9. Overhead view of drop box installation using multiple trenches with sequential distribution.**

### 3.2.7 Drainfield Cover

Drainfield cover consists of two components. These are the soil barrier and the soil placed over the soil barrier as final cover. Elements to consider for both components are discussed below.

#### 3.2.7.1 Soil Barrier

IDAPA 58.01.03.008.07 requires that drainfield aggregate must be covered throughout the drainfield by a soil barrier. For standard subsurface sewage disposal systems, standard absorption beds, seepage pits, and basic alternative systems, the soil barrier may consist of untreated building paper, synthetic filter fabric (geotextile), or a 3 inch layer of straw or other acceptable permeable material. Other permeable materials proposed for use as a soil barrier will be considered on a case-by-case basis and must be approved by DEQ prior to installation in the standard subsurface sewage disposal system. Some approved gravelless trench components used for drainfield aggregate replacement may not need to be covered with a soil barrier. The soil barrier requirements for each gravelless trench component should be based on the product manufacturer’s recommendations. Although straw and untreated building paper may be used to cover drainfield aggregate, geotextiles of greater than 1 ounce per square yard weight are recommended. These materials are particularly recommended in soils that may flow when wet, such as uniform fine sands or silts. Soil barriers used for all complex alternative systems shall use geotextile filter fabric to cover the drainfield aggregate. Additionally, all large soil absorption systems shall also use geotextile filter fabric as the soil barrier (IDAPA 8.01.03.013.04.i).



### 3.2.7.2 Soil Cover

Every drainfield must have a soil cover installed after the system's installation and subsequent final inspection by the health district. The minimum depth of soil that must be placed over the top of a drainfield is 12 inches (IDAPA 58.01.03.008.04). The maximum depth of soil cover that may be placed over the top of a drainfield is 36 inches (IDAPA 58.01.03.008.04). These depths are intended to keep effluent from reaching the ground surface through the drainfield, mitigate nuisance odors from the drainfield, and allow oxygen to reach the drainfield and its surrounding soils.

Soil used to cover the drainfield should be the same as or one soil group finer than that of the native site material around and above the drainfield. Cover soil should be consistent with one of the approved soil design groups provided in Table 2-4. No soil finer than clay loam should be used as cover over the drainfield. All soil used as cover shall be free of debris, stones, frozen clods, and ice or snow.

Care should be taken to account for settling of the cover soil. Extra cover may be necessary to achieve the desired fill depth after the cover soil settles. All cover placed over the drainfield should be placed in a manner that prevents the blockage and accumulation of surface runoff over the drainfield. Cover that is placed above grade should not exceed a 3:1 slope. Mechanical compaction of the drainfield cover is not allowed. The drainfield and associated soil cover shall not be covered by any impermeable surface barriers (IDAPA 58.01.03.008.09).

### 3.2.8 Drainfield Excavation Backfilling Materials and Alternative System Construction Media

Installation of a drainfield or the construction of several alternative systems requires that the drainfield excavation or alternative system be constructed with some type of media or aggregate. For any media used in a basic or alternative system, it is important that the media or aggregate meet certain size and cleanliness specifications to ensure the system's functionality and longevity. To ensure proper media or aggregate sizing and material cleanliness, it is necessary for the health districts to verify and inspect the media or aggregate installed in subsurface sewage disposal systems. Media and aggregate inspection and approval processes are discussed further below.

Upon excavation, native site soils are considered the same as fill material. For subsurface sewage disposal systems, excavation is considered any disturbance of the native site soils that causes the soil to lose its original compaction. Native site soils excavated for any portion of a subsurface sewage disposal system shall not be left in place or backfilled below a drainfield unless the material has successfully completed the evaluation process outlined in section 2.3. Scarification of soils as described in certain alternative system guidance is the only excavated native soil that is approved to be left below a drainfield. Scarification should only occur for the approved alternative systems in this manual that it is specified for. Manual raking of a drainfield excavation to alleviate soil smearing is not considered scarification.

### 3.2.8.1 Drainfield Aggregate and Construction Media Approval Process

Drainfield aggregate is any crushed rock or gravel that is durable, inert, free of fines, and has an effective diameter of 0.5 to 2.5 inches (IDAPA 58.01.03.008.08). Construction media is considered any earthen material specified for use in the construction of an alternative system. The following construction media is currently specified for use in alternative systems:

- Medium sand (also referred to as ASTM C-33 sand)
- Pea gravel
- Pit run material (consisting of clean sand and gravel)

Aggregate and construction media must come from an approved source before installation in any subsurface sewage disposal system. To become an approved source, a supplier (typically a material pit or storage yard) shall submit an annual sieve analysis for each source of drainfield aggregate or construction media that they would like to obtain approval of for installation in a standard or alternative subsurface sewage disposal system. The sieve analysis verifies compliance with material sizing and cleanliness specifications as specified in IDAPA 58.01.03.008.08 or verifies compliance with the recommendations for an approved alternative system (IDAPA 58.01.03.004.10). The sieve analyses from each source shall be submitted to the local health district for review and aggregate or construction media approval. Each health district shall maintain an approved source and materials list for their district and will provide a copy of this list to DEQ.

Health district approval of an aggregate or construction media source only provides verification that the source is capable of producing these materials in conformance with the material specifications. The health district may still disapprove drainfield aggregate or construction media if it becomes contaminated during processing, loading, transport, storage, or installation either at the source location or at a subsurface sewage disposal installation site. It is the responsibility of those processing, providing, transporting, storing, or installing the aggregate or media to ensure the drainfield aggregate or construction media maintains its approved characteristics (i.e., size and cleanliness).

The size and cleanliness characteristics of drainfield aggregate and construction media shall be evaluated using standard sieve analysis. The sieve sizing shall conform to ASTM standards. The size and cleanliness characteristics for each material are provided below.

#### 3.2.8.1.1 Drainfield Aggregate

Drainfield aggregate is commonly referred to as drainrock. The dimensions of this material are specified in IDAPA 58.01.03.008.08. The material is typically comprised of crushed rock or gravel, and the rock or gravel is of a durable and inert type. Other materials meeting the size and cleanliness specifications may be considered for use as drainfield aggregate if it can be shown that the material is both durable and inert. Alternative drainfield aggregate sources will be considered on a case-by-case basis. To determine if a drainfield aggregate is suitable, it must be passed through a sieve to ensure that 100% passes through a 2.5-inch sieve,  $\leq 2\%$  passes through a 0.5-inch sieve for size, and less than 2% passes through a #200 sieve for cleanliness (Table 3-3).

**Table 3-3. Drainfield aggregate allowable particle size percent composition.**

Sieve Size	Passing (%)
2.5 inch	100
0.5 inch	≤2
200	<2

### 3.2.8.1.2 Manufactured Medium Sand

To determine if a construction media meets the requirements for manufactured medium sand, the sand is passed through a sieve to ensure that it conforms to the following gradation requirements (Table 3-4).

**Table 3-4. Manufactured medium sand allowable particle size percent composition.**

Sieve Size	Passing (%)
4	95–100
8	80–100
16	50–85
30	25–60
50	10–30
100	2–10
200	<2

### 3.2.8.1.3 Pea Gravel

To determine if a construction media is pea gravel, the media is passed through a sieve to ensure that it conforms to the gradation requirements: 100% passes through a 3/8-inch sieve; <2% passes through a #7 sieve; and <1% passes through a #50 sieve for size and cleanliness (Table 3-5). Additionally, the media must have a uniformity coefficient of <2.

**Table 3-5. Pea gravel allowable particle size percent composition.**

Sieve Size	Passing (%)
3/8 inch	100
7	<2
50	<1

### 3.2.8.1.4 Pit Run

Pit run construction media is composed of clean cobble, gravel, and sand. To determine if a construction media is suitable pit run, it shall be passed through a sieve to ensure that it conforms to the gradation requirements: 100% passes through a 6-inch sieve; 15%–60% passes through a #4 sieve; ≥ 5% passes through a #50 sieve; and 0%–12% passes through a #200 sieve for size (Table 3-6).

**Table 3-6. Pit run allowable particle size percent composition.**

Sieve Size	Passing (%)
6 inch	100
4	15–60
50	≥5
200	0–12

**3.2.8.2 Substantiating Drainfield Aggregate and Construction Media Installation**

After delivery of the drainfield aggregate or construction media to a subsurface sewage disposal system installation site, the health district shall verify that the aggregate and/or media was obtained from an approved source as described in section 3.2.8.1. The permitted installer, property owner, or licensed public works contractor under the direction of a PE licensed in Idaho performing the subsurface sewage disposal system installation shall provide drainfield aggregate or construction media receipts to the health district upon request to verify source and volume (IDAPA 58.01.03.011.04). The health district shall record the volume of drainfield aggregate or construction media on the final inspection form for the installation permit. The volume of drainfield aggregate and construction media may also be used to verify the excavation depth of drainfield trenches.

**Example** (verification of excavation depth of an in-trench sand filter drainfield trench):

The drainfield covers a disposal area of 420 ft<sup>2</sup> and was installed with two 6-foot wide trenches that are 35 feet long each. The excavation depth of the system was required to be 7 feet with a maximum installation depth of 4 feet. To meet the excavation depth and install the drainfield no deeper than 4 feet, approximately 47 cubic yards (yd<sup>3</sup>) of medium sand must be installed below the drainfield aggregate. Another 15.6 yd<sup>3</sup> of drainfield aggregate should be installed to ensure that a minimum of 12 inches of aggregate is in place and that it is installed no deeper than 4 feet. This is determined by the following:

Medium Sand Volume:

$$(420 \text{ ft}^2 \text{ of disposal area}) \times (3 \text{ ft of medium sand}) = 1,260 \text{ ft}^3 \text{ of medium sand}$$

$$(1,260 \text{ ft}^3 \text{ of medium sand}) / (27 \text{ ft}^3/\text{yd}^3) = 46.67 \text{ yd}^3 \text{ of medium sand}$$

Drainfield Aggregate:

$$(420 \text{ ft}^2 \text{ of disposal area}) \times (1 \text{ ft of drainfield aggregate}) = 420 \text{ ft}^3 \text{ of drainfield aggregate}$$

$$(420 \text{ ft}^3 \text{ of drainfield aggregate}) / (27 \text{ ft}^3/\text{yd}^3) = 15.56 \text{ yd}^3 \text{ of drainfield aggregate}$$

### 3.3 Wastewater Flows

Revision: August 18, 2016

Assigning wastewater flow projections to a proposed subsurface sewage disposal system is necessary to adequately design the system and is required as part of the permit application by IDAPA 58.01.03.005.04.j. The term *wastewater flow* refers to the amount of wastewater a structure will generate in gallons per day (GPD). These flow estimates provide the basis for determining the minimum septic tank volume and subsurface disposal system sizing (IDAPA 58.01.03.007.07.b and 58.01.03.008.03.a). For most proposed projects, IDAPA 58.01.03.007.08 is used for providing the quantitative daily wastewater flow estimates necessary to design the proposed subsurface sewage disposal system.

Due to the limited number of commercial/industrial establishments and flow scenarios provided in IDAPA 58.01.03.007.08, not all proposed commercial or industrial projects will be capable of proposing daily wastewater flows based on this rule. IDAPA 58.01.03.005.04.d provides the applicant the allowance to propose wastewater flows through other appropriate measures to adequately size the subsurface sewage disposal facility. Daily wastewater flow projections may be provided from other sources when a proposed residential, commercial, or industrial project is not covered by IDAPA 58.01.03.007.08, or when an applicant feels that the daily wastewater flow projections for a commercial or industrial facility provided in IDAPA 58.01.03.007.08 are higher or lower than actual daily peak wastewater use for similar facilities.

Other appropriate measures for daily wastewater flow estimation as described in IDAPA 58.01.03.005.04.d must include the nature and quantity of wastewater the system will receive. Adequate documentation must be submitted with the permit application detailing the basis for the estimate of the quantity of wastewater and its nature (IDAPA 58.01.03.005.04.j). In the documentation include a description of the commercial or industrial facility's proposed operation, referred to as a Letter of Intended Use. Letter of Intended Use elements are described in section 3.3.1. Appropriate measures and documentation for the provision of empirical wastewater flow data not provided in IDAPA 58.01.03.007.08 are described in section 3.3.2.

#### 3.3.1 Letter of Intended Use

As part of the permit application, the applicant must provide information regarding the type of establishment served (IDAPA 58.01.03.005.04.c), nature and quantity of wastewater the system will receive (IDAPA 58.01.03.005.04.j), and documentation that substantiates that the proposed system will comply with IDAPA 58.01.03 (IDAPA 58.01.03.005.04.o). This information should be included in a Letter of Intended Use that contains the following minimum elements:

- Description of the commercial/industrial processes that are occurring within the facility.
  - Type of business that will be discharging to the subsurface sewage disposal system and the processes involved in its operations.
  - Maximum number of employees and customers within the facility at any given time now or in the future if expansion is to occur later.
  - Estimated daily wastewater flow that may be produced by the domestic, commercial, and industrial uses occurring within the facility. Estimated daily wastewater flow projections must either be supported by IDAPA 58.01.03.007.08 or follow the guidance regarding empirical wastewater flow data as provided in section 3.3.2.

- Completed copy of the subsurface sewage disposal permit application supplement for nondomestic wastewater. Characteristics of the nondomestic wastewater should be supported with adequate documentation.

### 3.3.2 Empirical Wastewater Flow Data

Empirical wastewater flow data is collected from facilities similar to the one proposed in the subsurface sewage disposal permit application. Wastewater flow data is typically collected from facilities connected to a public water system or other water source that can provide water meter data for daily, weekly, or monthly water use by the facility. The daily wastewater flow is estimated based upon the potable water used by the facility as determined by water meter data. The data obtained often needs to be converted into GPD as most utilities and public water systems do not meter water by the gallon. The volume of water provided in a water usage history should be verified for the correct meter units.

Evaluated facilities should be located within Idaho if possible and may be from any region within the state. Unique facilities that may not be found elsewhere in the state may use similar facilities from other states. Facilities should be able to be compared to the proposed facility and capable of assigning a daily wastewater flow estimate on a per unit basis. Units may include employees, meals, visitors, or any other quantifiable unit applicable to the proposed facility. If the proposed facility will produce nondomestic wastewater (i.e., wastewater from sources other than hand sinks, toilets, showers/bathtubs, noncommercial kitchens, and washing machines), the wastewater data must also include characterization of the proposed commercial or industrial wastewater to be discharged to the subsurface sewage disposal system in addition to the daily wastewater flow data.

The time of year that water usage data is collected and evaluated should represent the proposed facility's peak usage time frame. If possible, DEQ recommends that water consumption data devoid of irrigation flows be provided. To accomplish this, locate facilities that do not have landscaping to irrigate or eliminate the irrigation season from the evaluation. Eliminating the irrigation season from the water data evaluation should only be used for facilities that do not have peak facility use occur over this time frame. Water usage data that does not include the irrigation season typically occurs from November through February.

Adequate documentation of daily wastewater flows may vary on a case-by-case basis. The following list of water usage data will be considered adequate for most circumstances:

- Water usage data from a minimum of three facilities of similar operation should be provided for review.
  - Facilities should be connected to a public or private water system for which monthly water use records are kept that can be readily converted to average GPD flows. Water usage data should be provided in writing by the water system operator.
  - Statistics should be provided on each facility's operation that are pertinent to the wastewater flow estimation (e.g., number of employees, number of children attending a childcare, number of meals served per day for restaurants, and occupancy per day of a hotel or RV park). Statistical data for each facility should be provided in writing by the facility providing the data.

- Water usage data should occur over an adequate time frame to provide data that is applicable to the design flows for subsurface sewage disposal permit issuance.
- Wastewater characterization for nondomestic wastewater sources (including the subsurface sewage disposal permit application supplement for nondomestic wastewater found on DEQ's website).
- Other facility specific data the Director feels is reasonable and necessary for daily wastewater flow estimation evaluation.

The Director shall evaluate the data provided to determine an acceptable flow. If the Director determines that any data provided is inadequate for assessment, the facility that the data applies to will not be included in the evaluation process. The provision of empirical wastewater flow data in lieu of using the wastewater flows provided in IDAPA 58.01.03.007.08 does not guarantee that the daily wastewater flow projection will be less than what is provided by IDAPA 58.01.03.007.08.

### **3.4 References**

EPA (United States Environmental Protection Agency). 2002. *Onsite Wastewater Treatment Systems Manual*. Washington, DC: EPA. EPA/625/R-00/008.

*This page intentionally left blank for correct double-sided printing.*



## 4 Alternative Systems

### 4.1 General Requirements

Revision: February 4, 2016

All rules pertaining to standard subsurface sewage disposal systems shall be applicable, except as modified in this section for each alternative.

All alternative systems shall be approved for specific site use by the health districts in a manner consistent with the guidance provided within this manual for each alternative system.

Requirements for each site-specific alternative shall be contained in the permit.

The designer of all *public* systems, both standard and complex, must be a PE licensed in Idaho (Idaho Code §54-1218). Additionally, the public system's construction must be reviewed by a PE licensed in Idaho (Idaho Code §54-1218). The PE designing and overseeing the construction of any public system should be experienced in the system's design. Public systems include any system owned by the state, a county, city, school district, irrigation district, drainage district, highway district, or other subdivision of the state having power to levy taxes or assessments against property situated therein (Idaho Code §54-1218). The requirement for a PE to design and oversee construction of a public system shall not apply to public systems if (Idaho Code §54-1218):

- The construction, reconstruction, maintenance, and repair work is insignificant (less than \$10,000 in total cost), and
- The work is performed by employees of the public agency according to standards for such work (including, but not limited to, the Idaho standards for public works construction and any supplements thereto) that have been certified by a PE and duly adopted by the public agency's governing body, and
- A PE determines the public construction, reconstruction, maintenance, and repair work does not represent a material risk to public health or safety.

The designer of alternative *private* systems, other than those listed below, is required to be either a PE or an environmental health specialist. The PE must be licensed in Idaho and the environmental health specialist must be registered with the National Environmental Health Association, and both should be experienced in the alternative system's design. The designer of the following complex alternative *private* systems must be a PE licensed in Idaho unless otherwise allowed within the specific system's guidance:

- At-grade soil absorption system
- Drip distribution system
- Evapotranspiration and evapotranspiration/infiltrative system
- Experimental system
- Gray water system (if pressurized)
- Individual lagoon

- Pressure distribution system
- Recirculating gravel filter
- Intermittent sand filter
- Sand mound
- Subsurface flow constructed wetland

#### **4.1.1 Engineering Requirements**

Engineered designs and design or responsible charge engineers shall meet the following minimum requirements described in this section.

##### **4.1.1.1 Responsible Charge of Engineered Systems and Plans**

All new and repair or replacement systems that require engineered design shall have a new set of plans that have been stamped (sealed) by the design engineer unless the original design plan is accounted for and included in the design of the replacement system. If the original design plan is included in the design of the replacement system and that system design is in conformance with IDAPA 58.01.03 and the current applicable TGM alternative system design requirements, the existing plans may be used as long as those plans are stamped (sealed) by a responsible charge engineer (does not need to be the original design engineer) as required by Idaho Code §54-1223(5). A responsible charge engineer stamping (sealing) an existing set of plans for a replacement system should review the original work to ensure the following:

- Correct field parameters were evaluated.
- Existing design meets the requirements of IDAPA 58.01.03 and the current applicable TGM alternative system design requirements.
- System as designed can be installed in the designated area without any design plan modification.

##### **4.1.1.2 Operation and Maintenance of Engineered Systems**

All subsurface sewage disposal systems require some level of system operation and maintenance. Engineered systems typically require system operation and maintenance that is far more extensive than operation and maintenance required for standard systems. Per IDAPA 58.01.03.005.04.k, the design engineer shall provide an O&M manual as part of the subsurface sewage disposal permit application upon submission of the engineered design plans prior to permit issuance. The O&M manual should include information on the following areas at a minimum:

- Manufacturer recommended operation and maintenance for any commercially manufactured component used in a system's design.
- Operation and maintenance of the system necessary based on the system design.
- Operation and maintenance of the system as specified within the alternative system's design guidance in the TGM.
- A description of any monitoring procedures related to system function, failure detection, or system sampling.
- Corrective actions for system component malfunctions, alarms, or failure.
- Any other operation and maintenance as recommended by the system's design engineer.

### **4.1.1.3 As-Built Plans and Specifications of Engineered Systems**

As a condition of issuing a subsurface sewage disposal permit, the health district may require that complete and accurate drawings and specifications depicting the actual construction be submitted to the health district within 30 days after the completion of system construction (IDAPA 58.01.03.005.15). This requirement should be fulfilled by the system's responsible charge engineer for all systems that require engineered designs. As-built plans and specifications may be required when there are any deviations in construction from the permitted construction plans. If construction is completed in conformance with the permitted construction plans without deviation, the responsible charge engineer shall provide the health district with a written statement that the system was constructed and functions in compliance with the approved plans and specifications. It is recommended that the responsible charge engineer perform as many inspections of the system construction as necessary to provide the above documentation.

## **4.1.2 Plumbing and Electrical Permits**

Subsurface sewage disposal permits only cover the installation of a subsurface sewage disposal system (IDAPA 58.01.03.005.10) and provide documentation that the system is in compliance with IDAPA 58.01.03 and applicable alternative system requirements of the TGM (IDAPA 58.01.03.005.07). Subsurface sewage disposal systems begin at the septic tank and terminate at the end of the drainfield. Subsurface sewage disposal system permits do not include approval for installation of any plumbing preceding the septic tank or electrical components of a subsurface sewage disposal system. Requirements for these components are discussed in the following sections.

### **4.1.2.1 Plumbing Permits and Inspections**

Any wastewater plumbing preceding a septic tank is under the jurisdiction of the Idaho Division of Building Safety Plumbing Program. All requirements related to this section of wastewater plumbing are governed by the Idaho State Plumbing Code. A permit for the installation of this plumbing and any necessary inspections of this plumbing must be obtained through the Idaho Division of Building Safety Plumbing Program. Health districts only have jurisdiction, including permitting and inspection authority, over the subsurface sewage disposal system. Health districts are not responsible for determining that any permit has been obtained for plumbing preceding the septic tank or that the plumbing preceding the septic tank is in compliance with the Idaho State Plumbing Code. A subsurface sewage disposal installer's registration permit issued under IDAPA 58.01.03.006 is not a substitute for a plumbing contractor license.

### **4.1.2.2 Electrical Permits and Inspections**

Some alternative subsurface sewage disposal systems contain components that require an electrical connection. All electrical connections are under the jurisdiction of the Idaho Division of Building Safety Electrical Program. A permit for the electrical work necessary to connect these components to an electrical supply and any necessary inspections of the electrical work must be obtained through the Idaho Division of Building Safety Electrical Program. Health districts are not responsible for determining that any permit has been obtained for electrical work related to a subsurface sewage disposal system or that the electrical work is in compliance with the National Electrical Code. A subsurface sewage disposal installer's registration permit issued

under IDAPA 58.01.03.006 is not a substitute for an electrical contractor license. Permitted subsurface sewage disposal system installers that do not hold a current electrical contractor license should not perform any electrical work related to a subsurface sewage disposal system. *It is highly recommended that health districts verify that a proper electrical inspection has been performed by the Idaho Division of Building Safety Electrical Program on any subsurface sewage disposal system component requiring electrical connection prior to coming into contact with the component, or any liquid that may be in contact with that component.*

#### 4.1.3 Multiple Alternative Systems Combined into One System Design

An alternative system is any system that DEQ has issued design guidelines for (IDAPA 58.01.03.003.02), which are contained within section 4 of this manual. Alternatively, a standard system is any system that DEQ's Board of Environmental Quality has recognized through the adoption of design and construction regulations in IDAPA 58.01.03. Standard systems include a septic tank and aggregate-filled drainfield or absorption bed. Any modification of a standard system design as described in IDAPA 58.01.03.008 is considered an alternative system. Alternative systems may be classified as either a basic alternative system or a complex alternative system. All complex alternative systems are listed in section 1.5. Any system not considered a standard system or listed as a complex alternative system in section 1.5 is considered a basic alternative system.

Alternative systems are allowed to be used to address difficult sites that are not capable of supporting a standard system. Alternative systems provide property owners with more options to meet their subsurface sewage disposal needs. Alternative systems have solved some subsurface sewage disposal issues for difficult sites but are not a solution for all sites. Some sites are not suitable for subsurface sewage disposal due to limiting site conditions (e.g., shallow soils, high ground water, surface water, or steep slopes) or size. To reduce the number of sites that are not considered suitable for subsurface sewage disposal, the TGC and DEQ encourage using multiple alternative system designs in a single system's design. The following restrictions apply to combining multiple alternative systems into one system design:

1. The bottom of a drainfield may not be installed deeper than 48 inches below native grade.
2. Systems requiring the use of pressurization for any component may not substitute gravity flow for the pressurization of that component.
3. The most restrictive site slope requirements for any one alternative used in a system's design shall be adhered to.
4. The design guidance for all alternative systems used in a system's design shall be followed.
5. Only one allowance for reducing trench length, total disposal area, or an alternative hydraulic application rate shall be used in a system's design regardless of the number of alternative designs combined into one system that provide these types of reduction allowances.
6. Only one allowance for reducing separation distance to limiting layers or features of interest shall be used in a system's design regardless of the number of alternative designs combined into one system that provide these types of reduction allowances.

Table 4-1 provides a matrix of compatible alternative systems that may be combined and used for a single system's design. Any number of alternative system designs may be used in a single system's design as long as all of the alternatives are compatible with one another.

**Table 4-1. Matrix of compatible alternative systems that may be combined and used for a single system’s design.**

Alternative System	At-Grade Soil Absorption System (4.2)	Capping Fill System (4.3)	Drip Distribution System (4.5)	Experimental System (4.7)	Extended Treatment Package System (4.8)	Extra Drain-rock Trench (4.9)	Gravel-less Trench System (4.11)	Pressure Distribution System (4.19)	Recirculating Gravel Filter (4.21)	Intermittent Sand Filter (4.22)	In-Trench Sand Filter (4.23)	Sand Mound (4.24)	Seepage Pit/Bed (4.25)	Steep Slope System (4.26)	Drainfield Remediation Components (4.30)
At-Grade Soil Absorption System (4.2)	S	N	A*	A	A	N	N	A*	A	A	N	N	N	N	A
Capping Fill System (4.3)	N	S	A	A	A	A	A	A	A	A	A	N	N	N	A
Drip Distribution System (4.5)	A*	A	S	A	A	A*	A*	A	A**	A**	A*	A*	N	A*	A
Experimental System (4.7)	A	A	A	S	A	A	A	A	A	A	A	A	A	A	A
Extended Treatment Package System (4.8)	A	A	A	A	S	A	A	A	A	A	A	A	A	A	A
Extra Drainrock Trench (4.9)	N	A	A*	A	A	S	N	A	A	A	A	N	N	A	A
Gravelless Trench System (4.11)	N	A	A*	A	A	N	S	A	A*	A*	A	A	N	A	A
Pressure Distribution System (4.19)	A*	A	A	A	A	A	A	S	A	A	A	A	N	A	A
Recirculating Gravel Filter (4.21)	A	A	A**	A	A	A	A*	A	S	A	A	A	A	A	A
Intermittent Sand Filter (4.22)	A	A	A**	A	A	A	A*	A	A	S	A	A	A	A	A
In-Trench Sand Filter (4.23)	N	A	A*	A	A	A	A	A	A	A	S	N	N	A	A

Alternative System	At-Grade Soil Absorption System (4.2)	Capping Fill System (4.3)	Drip Distribution System (4.5)	Experimental System (4.7)	Extended Treatment Package System (4.8)	Extra Drain-rock Trench (4.9)	Gravel-less Trench System (4.11)	Pressure Distribution System (4.19)	Recirculating Gravel Filter (4.21)	Intermittent Sand Filter (4.22)	In-Trench Sand Filter (4.23)	Sand Mound (4.24)	Seepage Pit/Bed (4.25)	Steep Slope System (4.26)	Drainfield Remediation Components (4.30)
Sand Mound (4.24)	N	N	A*	A	A	N	A	A	A	A	N	S	N	N	A
Seepage Pit/Bed (4.25)	N	N	N	A	A	N	N	N	A	A	N	N	S	N	A
Steep Slope System (4.26)	N	N	A*	A	A	A	A	A	A	A	A	N	N	S	A
Drainfield Remediation Components (4.30)	A	A	A	A	A	A	A	A	A	A	A	A	A	A	S

Notes: A—Compatible alternative system types; N—Not compatible alternative system types; S—Same alternative system type; (\*)—May be used as the distribution method within the drainfield; (\*\*)—May be used as distribution method within the filter as well as the drainfield.

## 4.2 At-Grade Soil Absorption System

Revision: July 22, 2015

Installer registration permit: Complex

Licensed professional engineer required: Yes

### 4.2.1 Description

An at-grade soil absorption system is installed with the distribution aggregate placed at the original soil surface. Wastewater is distributed through the aggregate using a pressurized small-diameter pipe distribution system to ensure equal distribution across the infiltrative surface. The aggregate is covered with geotextile fabric and capped with at least 12 inches of soil cover. Figure 4-1 provides a diagram of an at-grade soil absorption system.

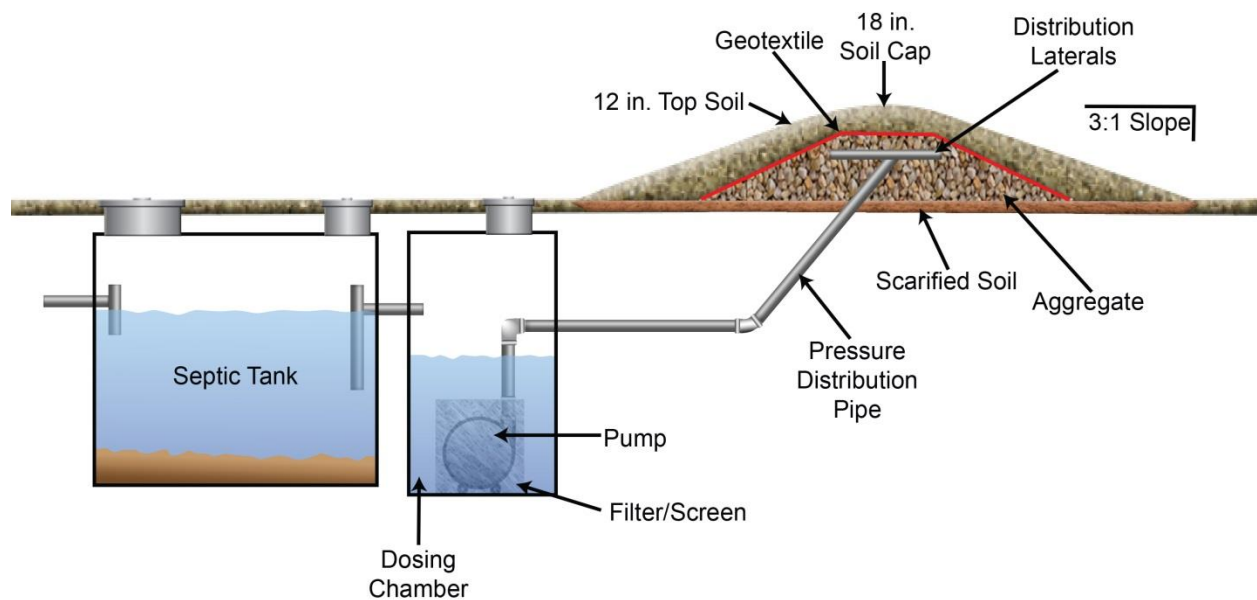

Figure 4-1. Cross-sectional view of an at-grade soil absorption system.

### 4.2.2 Approval Conditions

1. The system must be designed by a PE licensed in Idaho.
2. Effective soil depth to limiting layers shall meet the requirements of IDAPA 58.01.03.008.02.c. If a secondary treatment system is incorporated into the system design before discharge to the at-grade soil absorption system, the effective soil depth to any limiting layer shall not be reduced to less than 36 inches.
3. The soil application rate used in the at-grade soil absorption system design is based on the most restrictive soil layer within the soil profile's effective soil depth as determined by approval condition 2 except that the application rate shall not be increased for the incorporation of secondary effluent treatment before discharge to the at-grade soil absorption system.
4. Table 4-2 shows the maximum slope of natural ground, listed by soil design group.



5. Drainfield media shall consist of aggregate meeting the specifications of section 3.2.8.1.1.
  - a. Gravelless trench components shall not be substituted for drainfield aggregate in the system design.
  - b. No reduction is granted for installation of extra drainrock below the distribution pipe.
6. At-grade soil absorption system must not be installed in flood ways, areas with large trees and boulders, in concave slopes, at slope bases, or in depressions.
7. Design flow must be 1.5 times the wastewater flow.
8. The maximum daily wastewater flow to any at-grade soil absorption system must be equal to or less than 500 GPD, not including the required safety factor adjustment.
9. Nondomestic wastewater must be pretreated to residential strength before discharge to the at-grade soil absorption system.
10. Pressure distribution system and associated component design shall conform to section 4.19 of this manual unless otherwise provided within this section.

**Table 4-2. Maximum slope of natural ground.**

Design Group	A	B	C-1	C-2
Slope (%)	20	20	12	6

### 4.2.3 Design

Minimum design requirements for the at-grade soil absorption system are provided below.

#### 4.2.3.1 Effective Absorption Area Design

The effective absorption area dimensions are determined through the daily design flow plus safety factor, assigned soil application rate, and the contour loading rate of the site. Effective absorption areas should be designed as long and narrow as possible to reduce the contour loading rate, increase the effective absorption area, and protect the at-grade soil absorption system from failure.

1. Determine the daily design flow and multiply it by the safety factor of 1.5.  
*Example: Three bedroom home (250 GPD). Design flow (250 GPD x 1.5) = 375 GPD.*
2. Determine the minimum necessary soil absorption area based on the daily design flow with the safety factor and the effective soil profile’s most restrictive soil application rate.  
*Example: Three bedroom home (375 GPD) on a site with B-2 soils (0.45 GPD/ft<sup>2</sup>). Soil absorption area: (375 GPD/0.45 GPD/ft<sup>2</sup>) = 834 ft<sup>2</sup>.*
3. Assign a contour loading rate. Contour loading rates are the responsibility of the system’s design engineer to assign and should take into account soil texture, soil structure, and limiting layers existing in the soil profile.

- a. Contour loading rates shall not be less than 2 gallons per foot or more than 12 gallons per foot for a site and should fall between the values provided in Table 4-3 for each at-grade soil absorption cell.
- b. If more than one at-grade soil absorption cell is required for a single system, each cell shall have the same contour loading rate based on the most restrictive rate for the site.
- c. Contour loading rates are additive along a site’s slope for each at-grade soil absorption cell as shown in Figure 4-2.
- d. The following resources provide for more information on designation of contour loading rates:
  - Converse, J.C. 1998. *Linear Loading Rates for On-Site Systems*.
  - Tyler, E.J. and L. Kramer Kuns. No date. *Designing with Soil: Development and Use of a Wastewater Hydraulic Linear and Infiltration Loading Rate Table*.
  - Tyler, E.J. No date. *Hydraulic Wastewater Loading Rates to Soil*.

**Table 4-3. Linear loading rate ranges based on soil design subgroups.**

Design Subgroup	A-1	A-2a	A-2b	B-1	B-2	C-1	C-2
Contour loading rate range (GPD/ft)	2-8	2-8	2-7	2-6	2-5	2-4	2-3

4. The effective absorption cell width is calculated by dividing the contour loading rate selected for the site by the soil application rate. Effective absorption cell width shall not exceed 15 feet.

*Example: Site with B-2 soils (0.45 gallon/ft<sup>2</sup>) and a selected contour loading rate of 4 GPD/ft. Absorption cell width: (4 GPD/ft/0.45 gallon/ft<sup>2</sup>) = 8.9 feet, use 9 feet. Round up to nearest half-foot for design purposes.*

5. The absorption cell length is calculated by dividing the daily design flow by the contour loading rate.

*Example: Three bedroom home (375 GPD) and a selected contour loading rate of 4 GPD/ft. Absorption cell length (375 GPD/4 GPD/ft) = 93.75 feet round to 94 feet for design purposes.*

6. Ensure the at-grade absorption cell dimensions length and absorption area width meet or exceed the minimum soil absorption area calculated in step 2. If the absorption cell dimensions do not exceed the minimum absorption area required, decrease the selected contour loading rate selected in step 3 to achieve the minimum required absorption area.

*Example 4: Required absorption area = 696 ft<sup>2</sup>. Design area: (79 x 9 feet) = 711 ft<sup>2</sup>.*

7. Effective absorption area within an aggregate cell shall be credited based on the following requirements:
  - a. Flat sites—The absorption area is credited for the full width of the aggregate cell.
  - b. Sloped sites—The absorption area is credited from the downhill side of the pressurized distribution lateral to the downhill edge of the aggregate cell.

## Plan View

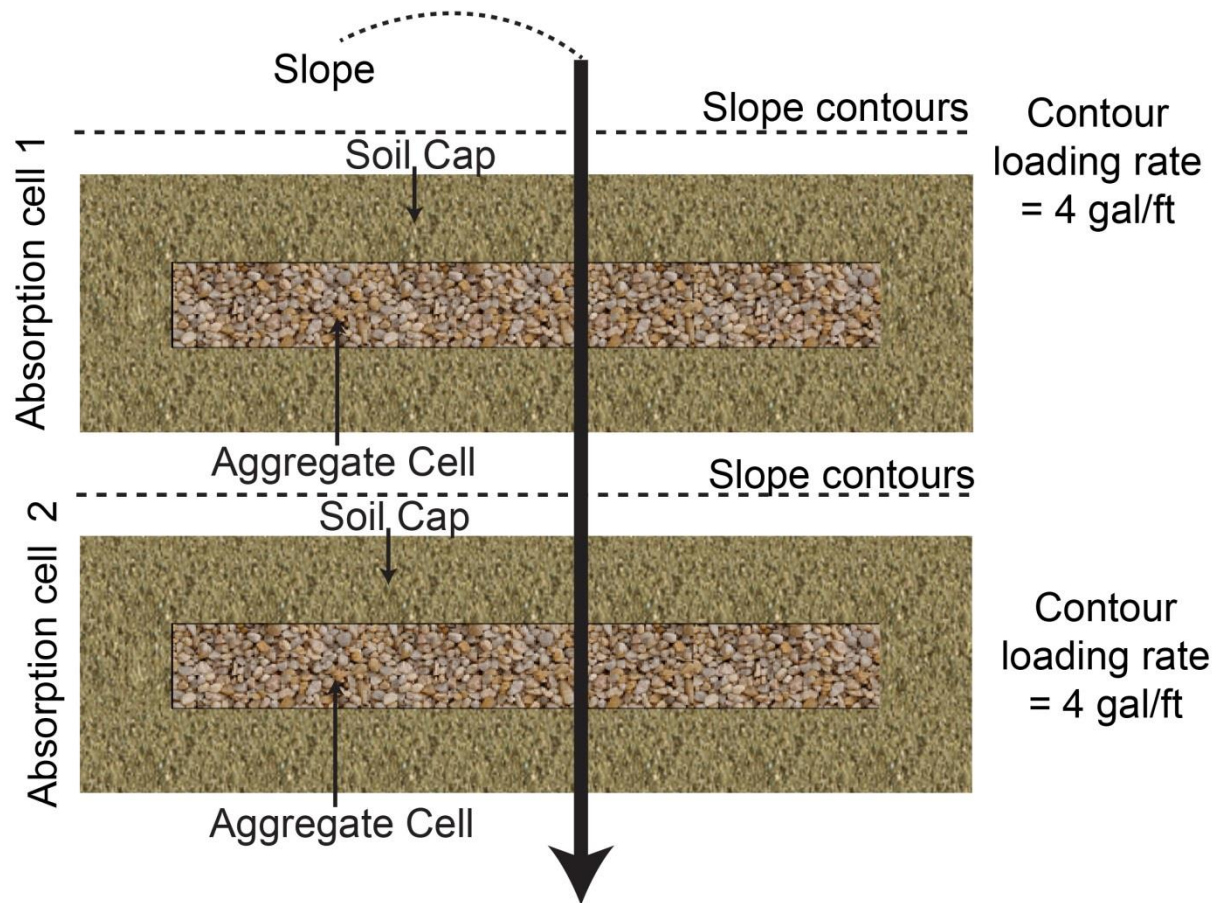

Total CLR for this two-cell system is:  
 $4 \text{ gal/ft} + 4 \text{ gal/ft} = 8 \text{ gal/ft}$   
 Since  $8 \text{ gal/ft} < 12 \text{ gal/ft}$ , this system design is allowable.

Figure 4-2. Additive contour loading rate example.

### 4.2.3.2 Pressure Distribution Design

The design of the low-pressure distribution system shall meet the requirements of section 4.19 with the exception of the requirements contained within this section.

1. Pressurized distribution lateral placement and spacing within the aggregate cell shall meet the following requirements:
  - a. Flat sites—The lateral placement shall meet the requirements for beds and spacing shall meet the requirements for distribution laterals in section 4.19.3.1.
  - b. Sloped sites—Only one pressurized distribution lateral is required, and it shall be placed on the upslope edge of the aggregate.

2. The maximum orifice spacing shall meet the following requirements:
  - a. Flat sites—The orifice spacing shall result in a maximum disposal area of 6 ft<sup>2</sup> per orifice.
  - b. Sloped sites—The orifice spacing shall not be greater than 12 inches.
3. Dosing is recommended to be timed but may be demand.
4. Each dose delivered to the infiltrative surface of the at-grade absorption system should not exceed 15% of the daily wastewater flow prior to the addition of a safety factor.

*Example: Three bedroom home (250 GPD prior to the addition of a safety factor). Each dose delivered to the infiltrative surface would not exceed 37.5 gallons total.*

#### **4.2.3.3 Aggregate Cell Design**

At-grade absorption cells must be filled with aggregate meeting the requirements of section 3.2.8.1.1. The aggregate cell must account for the effective absorption area and meet the additional design requirements below.

1. Aggregate must be placed along the slope contour on the uphill side of the at-grade soil absorption system for sloped sites.
2. Aggregate placement must be at least 6 inches deep below and at least 2 inches above the pressurized distribution pipe (Figure 4-3).
3. Aggregate must be placed in a consistent depth meeting the minimum requirements described in aggregate cell design requirement 2 throughout the entire effective absorption area after which the aggregate shall be tapered to meet native grade at a maximum slope of 3:1.
4. An additional 3 feet of aggregate must be placed as described in design requirement 2 on either end of the aggregate cell that extends past the terminal ends of the pressurized distribution pipe.
  - a. This additional aggregate shall not be credited as part of the effective absorption area.
  - b. After the additional aggregate placement is met, the aggregate may taper to native grade at a maximum slope of 3:1
5. On sloped sites, the aggregate upslope of the pressurized distribution pipe shall be tapered to native grade at a maximum slope of 3:1 but shall not be shorter than 2 feet.
6. Three observation ports should be installed at the toe edge of the aggregate cell extending from the drainrock/native soil interface through the soil cap at approximately the one-sixth, one-half, and five-sixth points along the aggregate cell.
  - a. The observation ports should contain perforations in the side of the pipe extending up 4 inches from the bottom of the port.
  - b. Observation ports must be accessible from grade, have a removable cap, and be stabilized to prevent their removal.



- a. The downslope soil cap width is calculated by multiplying the height of the at-grade soil absorption system by the correction factor, and adding 5 feet to the total width of the absorption cell, or a minimum of 15 feet. Whichever value is greater is used as the downslope cap width.

*Example: The height of the at-grade soil absorption system (aggregate plus cap) is 1.75 feet (9 inches of aggregate plus 12 inches of soil cover). The downslope soil cap width on a 10% slope would be 1.75 feet x 6.67, or 11.7 feet. Use the minimum width of 15 feet. The soil cap would extend 15 feet from the downslope edge of the aggregate cell.*

- b. The upslope soil cap width is calculated by multiplying the height of the at-grade absorption system by the correction factor.

*Example: The height of the at-grade soil absorption system (aggregate plus cap) is 1.75 feet (9 inches of aggregate plus 12 inches of soil cover). The upslope soil cap width on a 10% slope would be 1.75 feet x 2.86, or 5 feet. The soil cap would extend 5 feet from the upslope edge of the aggregate cell.*

- c. The soil cap extending from the ends of the aggregate cell shall be determined by adding 5 feet to half of the absorption cell width or a minimum of 10 feet, whichever value is greater.

*Example: The aggregate cell has a design width of 9 feet. The soil cap width would be 5+ 4.5 feet, or 9.5 feet. Use the minimum width of 10 feet. The soil cap would extend 10 feet from the ends of the aggregate cell.*

- d. All sides of the soil cap must maintain a maximum slope of 3:1 or less.

**Table 4-4. Downslope and upslope correction factors for soil cap width.**

Slope (%)	1	2	3	4	5	6	7	8	9	10	11	12	13	14	15	16	17	18	19	20
<b>Downslope Correction Factor</b>	4.17	4.35	4.54	4.76	5.00	5.26	5.56	5.88	6.25	6.67	7.14	7.69	8.26	8.92	9.57	10.24	10.94	11.67	12.42	13.2
<b>Upslope Correction Factor</b>	3.85	3.7	3.57	3.45	3.33	3.23	3.12	3.03	2.94	2.86	2.78	2.7	2.62	2.55	2.48	2.41	2.35	2.29	2.23	2.18

- 4. The texture of the fill material used for the soil cap shall be the same as or one soil design subgroup finer than the upper layer of the natural site soil, except that no fill material finer than clay loam may be used.
- 5. The soil cap material shall be free of debris, stones, frozen clods, or ice.
- 6. Soil cap should be protected to prevent damage caused by vehicular, livestock, or excessive pedestrian traffic. The toe of the soil cap must be protected from compaction.
- 7. Design considerations for at-grade soil absorption systems on slopes should take surface runoff diversion into account.

#### 4.2.4 Construction

1. Lay out the system with the length following the slope contour.
2. Grass and shrubs must be cut close to the ground surface and removed from the at-grade soil absorption system site.
  - a. If extremely heavy vegetation or organic mat exists, these materials should be removed before scarification and replaced with medium sand meeting the specification requirements in section 3.2.8.1.2.
  - b. Larger than 2-inch caliper trees and shrubs and large boulders are not to be removed. Trees should be cut as close to ground level as possible and the stumps left in place. If stumps or boulders occupy a significant area in the at-grade soil absorption system placement area, additional area should be calculated into the total basal area of the at-grade soil absorption system to compensate for the lost infiltrative area.
2. When the soil is dry and site vegetation has been cut or removed, the ground in the basal placement area of the at-grade soil absorption system and soil cap should be scarified using a chisel plow or backhoe teeth to a depth of 6–8 inches.
3. Pressure transport line from the dosing chamber should be installed first.
  - a. The pressure transport line should slope down to the pump so that the pressure line will drain between discharges.
  - b. If a downward slope from the at-grade soil absorption system to the pump chamber is not practical due to the length of run, then the pressure transport line should be laid level below the anticipated frost line for that region.
  - c. On a sloped site, the pressure transport line should enter the aggregate cell from the end of the aggregate cell or upslope side of the at-grade soil absorption system; do not enter the aggregate cell from the downslope side of the system.
4. Six inches of clean aggregate will then be placed and shaped before it freezes or rains. No vehicles with pneumatic tires should be permitted on the scarified area to prevent the soils from being compacted. For sloped sites, all work should be done from the upslope side or ends of the at-grade soil absorption system placement area if possible.
5. After shaping the first 6 inches of aggregate, the low-pressure distribution system manifold, laterals, and monitoring ports will be installed. The system should be tested for uniformity of distribution. After uniformity is verified, an additional lift of clean aggregate shall be placed, shaped, and leveled to ensure the aggregate extends at least 2 inches above the low-pressure distribution system.
6. Geotextile fabric must be placed over the aggregate cell and backfilled with the soil cap.
7. Typical lawn grasses or other appropriate low-profile vegetation should be established on the soil cap as soon as possible, preferably before the system is put into operation. Do not plant trees or shrubs on the soil cap, or allow the mature rooting radius of trees or shrubs to reach the soil cap. Trees with roots that aggressively seek water should be planted at least 50 feet from the at-grade soil absorption system and soil cap (e.g., poplar, willow, cottonwood, maple, and elm).

8. At-grade soil absorption systems placed upslope and downslope from each other should maintain a soil cap-toe to soil cap-toe separation distance of 35 feet (Figure 4-4).
  - a. The first 15 feet below the upslope at-grade soil absorption system should remain free of vehicular traffic and other activities resulting in soil compaction.
  - b. The 20 feet above the downslope at-grade soil absorption system should be maintained for construction of the downslope mound.
9. A separation distance of 15 feet should be maintained from the soil cap-toe of each at-grade soil absorption system when multiple at-grade soil absorption systems are constructed on the same elevation contour.

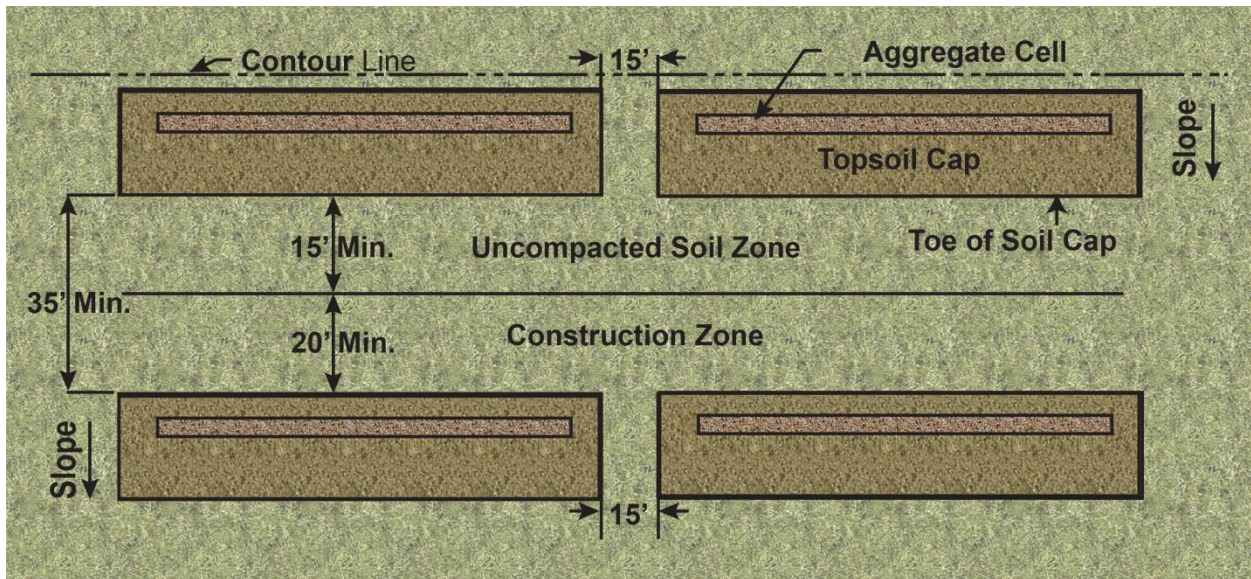

Figure 4-4. At-grade soil absorption systems placed upslope and downslope from one another.

#### 4.2.5 Inspections

1. Site inspections shall be conducted by the health district at the following minimum intervals (IDAPA 58.01.03.011.01):
  - a. Preconstruction conference with the health district, responsible charge engineer, complex installer, and property owner (if available) present.
  - b. During construction as needed, including scarification, pressure line installation, absorption cell construction, pressure distribution piping construction, and soil cap placement.
  - c. Final construction inspection including a pump drawdown/alarm check, pressure test of the distribution network, and soil cap material and placement.
2. The responsible charge engineer shall provide the health district with a written statement that the system was constructed and functions in compliance with the approved plans and specifications. Additionally, the responsible charge engineer shall provide as-built plans to the health district if any construction deviations occur from the permitted construction plans (IDAPA 58.01.03.005.15).



#### 4.2.6 Operation and Maintenance

An O&M manual shall be developed by the system's design engineer that contains the following minimum requirements and shall be submitted as part of the permit application (IDAPA 58.01.03.005.14):

1. Operation and maintenance is the responsibility of the system owner.
2. Sludge depth in the septic tank should be checked annually, and the tank should be pumped when the sludge exceeds 40% of the liquid depth.
3. All pump and pump chamber alarm floats and controls should be inspected on a regular schedule to ensure proper function.
4. Pump screens and effluent filters should be inspected regularly and cleaned. All material created by cleaning the screen should be discharged to the septic tank.
5. Monitoring port caps should be removed and the monitoring ports observed for ponding. Corrective action should be taken if excessive ponding is present, as specified by the system design engineer.
6. Observation ports for testing the residual head should be inspected regularly to ensure the minimum system design for residual head is met.
7. Lateral flushing should occur annually to ensure any biomat buildup is removed from the distribution lateral. Lateral flushing procedures should be described and include a method to prevent wastewater and sludge from creating a public health hazard (e.g., routing flushed water and sludge back to the inlet of the septic tank via a dedicated hose).
8. Any other operation and maintenance as recommended by system component manufacturers and the system design engineer.

## 4.3 Capping Fill System

Revision: November 5, 2020

Installer registration permit: Property owner or standard and basic

Licensed professional engineer required: No

### 4.3.1 Description

A capping fill trench is a drainfield constructed so that its bottom is at least 3 inches into the natural soil but less than 2 feet deep in the natural soil. A selected fill material caps the trench to cover the drainfield aggregate or gravelless trench product. The two subcategories of a capping fill system are (1) below-grade capping fill system and (2) above-grade capping fill system. Capping fill systems may be installed by any installer with a basic installer's permit unless a complex component is used in conjunction with the capping fill system design.

### 4.3.2 Below-Grade Capping Fill System

A below-grade capping fill system is constructed so the bottom of the drainfield is less than 24 inches deep in the natural soil but deep enough in the natural soil to keep the entire drainfield below the natural soil. The installation depth is between 12 and 24 inches below the natural soil. The bottom depth of the drainfield necessary to keep the drainfield below the natural soil may be deeper for gravelless system products or combination extra drainrock and below-grade capping fill systems (Figure 4-5).

#### ***Below-Grade Capping Fill System Approval Conditions***

1. Effective soil depths below the drainfield bottom must be met as required by IDAPA 58.01.03 or as allowed in section 2.2 of this manual following the separation distance hierarchy.
2. Site may not exceed 20% slope.
3. The soil cap may be constructed before system excavation but after natural soil scarification if the cap must extend above the natural soil to achieve the minimum cover requirement of 12 inches.
4. The fill material (section 4.3.4), construction (section 4.3.5), and inspection (section 4.3.6) requirements must be met.

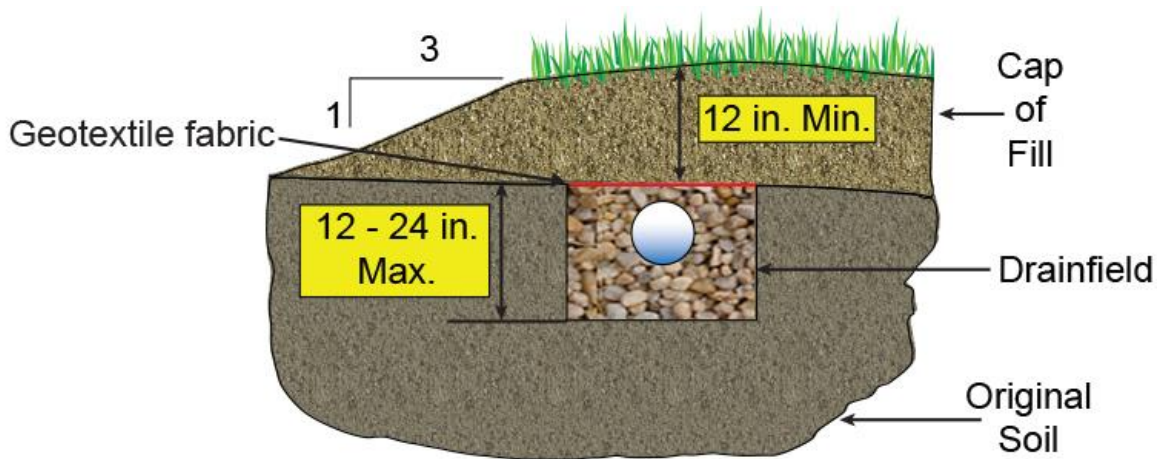

Figure 4-5. Cross-sectional view of a below-grade capping fill trench.

### 4.3.3 Above-Grade Capping Fill System

An above-grade capping fill system is constructed so that the upper portion of the drainfield is above the natural soil. The drainfield installation depth is typically less than 12 inches deep for a standard drainrock and perforated pipe drainfield. The bottom depth of the drainfield that results in the upper portion of the drainfield being above the natural soil may be deeper for gravelless system products or combination extra drainrock and capping fill systems (Figure 4-6).

#### ***Above-Grade Capping Fill System Approval Conditions***

1. Effective soil depth below the drainfield bottom must be met as required by IDAPA 58.01.03 or as allowed in section 2.2 of this manual following the separation distance hierarchy.
2. Site may not exceed 12% slope.
3. The soil cap must be constructed before system excavation but after natural soil scarification when constructing with pipe and aggregate.
4. The soil cap shall be compacted to 90% of the existing soils.
5. The soil cap shall extend at least 10 feet beyond the nearest trench sidewall in all directions.
6. The invert of the perforated distribution pipe in a combination extra drainrock and above-grade capping fill system shall not extend more than 3 inches above the natural soil.
7. The bottom of the drainfield shall be installed no shallower than 3 inches below the natural soil.
8. The minimum cover over the drainfield shall be 18 inches.
9. The fill material (section 4.3.4), construction (section 4.3.5), and inspection (section 4.3.6) requirements must be met.

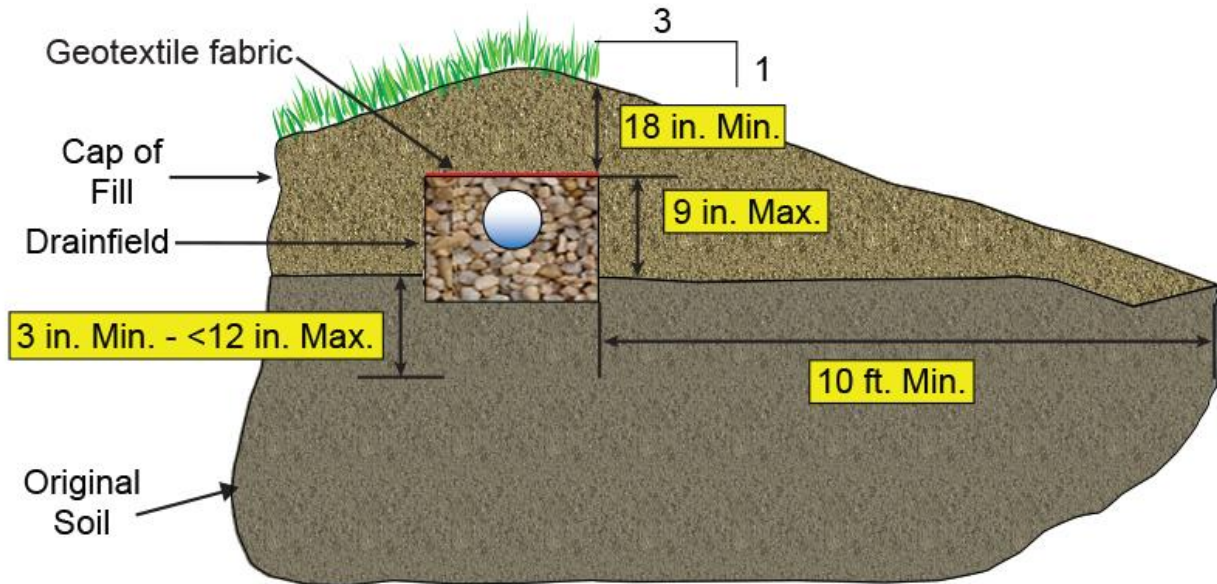

Figure 4-6. Cross-sectional view of an above-grade capping fill trench.

#### 4.3.4 Fill Material

The capping fill drainfield must meet the minimum cover requirements described in sections 4.3.2 and 4.3.3 and the maximum (36 inches) cover requirements of IDAPA 58.01.03.008.04. Fill material must be imported or removed from a location greater than 6 feet away from the edge of the drainfield cap to meet the texture requirements of the cap. The material requirements for the cap are as follows:

1. The upper layer of the natural site soil must be one of the approved effective soil design subgroups as described in Table 2-4.
2. The texture of the fill material used for the soil cap shall be the same as or one soil design subgroup finer than the upper layer of the natural site soil, except no fill material finer than clay loam may be used.
3. Fill material shall be free of debris, stones, frozen clods, or ice.

#### 4.3.5 Construction

1. When the fill cap must extend above the natural ground, the entire cap area is scarified to a depth of 6–8 inches using a chisel plow or backhoe teeth to disrupt the vegetative mat. Smearing the soil during scarification shall be avoided.
2. Site soil should not be removed during the scarification process unless heavy vegetation (e.g., bushes) or heavy vegetative mat is present. Any site soil that is removed should be replaced with medium sand before system construction.
3. Construction-related requirements in sections 4.3.2 and 4.3.3 shall be followed.
4. Systems shall be installed to a depth below the natural soil surface according to the specifications outlined on the permit.
5. Finished side slopes of the fill are to be evenly graded from the outer edges of the trenches to the natural soil surface with a maximum slope of 3:1 or less (three horizontal to one vertical).

6. Compaction of the scarified area must be prevented. Use of equipment with pneumatic tires is prohibited on the scarified area and fill or cover.
7. At least 12 inches of fill must be applied to cover the trenches in a below-grade capping fill system, and 18 inches of fill must be applied to cover the trenches in an above-grade capping fill system.

#### **4.3.6 Inspections**

1. Site soil texture, fill soil texture, and the scarification or vegetative mat disruption process will be inspected by the Director.
2. Installed trenches will be inspected by the Director prior to cover.
3. Final inspection after covering may be conducted by the Director to ensure proper cap placement and slope.

## 4.4 Composting Toilet

Revision: January 30, 2017

Installer registration permit: Property owner or standard and basic

Licensed professional engineer required: No

### 4.4.1 Description

Composting toilets are those within a dwelling that store and treat nonwater-carried human urine and feces and small amounts of household garbage by bacterial decomposition. The resultant product is compost.

### 4.4.2 Approval Conditions

1. Water under pressure shall not serve the dwelling unless a public sewer or another acceptable method of on-site disposal is available.
2. Composting toilet models must be approved by DEQ before installation (section 5.5).
3. Units are restricted to the disposal of human feces, urine, and small quantities of household garbage.

Household garbage should be limited to the manufacturer's recommendations.

Chemicals, pharmaceuticals, and nonbiodegradable products (e.g., plastics) should not be disposed of in a composting toilet.

### 4.4.3 Design Requirements

1. All materials used in toilet construction must be durable and easily cleanable. Styrene rubber, polyvinyl chloride (PVC), and fiberglass are examples of acceptable materials.
2. Design must demonstrate adequate resistance to internal and external stresses.
3. All mechanical and electrical components should be designed to operate safely and be capable of providing continuous service under reasonably foreseen conditions such as extreme temperatures and humidity.
4. Toilet unit must be capable of accommodating full- or part-time use.
5. Continuous positive ventilation of the storage or treatment chamber must be provided to the outside.
  - a. Ventilation components should be independent of other household ventilation systems.
  - b. Venting connections must not be made to room vents or to chimneys.
  - c. All vents must be designed to prevent flies and other insects from entering the treatment chamber.

### 4.4.4 Compost Disposal

1. Compost material produced by a composting toilet may be utilized as a soil amendment additive.
2. Compost material used as a soil additive should be incorporated into the native soil immediately after application.

3. Sewage products should be allowed to compost to the point that they are not identifiable as human waste prior to use as a soil additive.
4. It is recommended that nondegraded waste products either be transferred to a second compost container prior to use as a soil additive for further breakdown or disposed of in an approved landfill.
5. Composted toilet waste should not be used as a soil additive for edible fruit or vegetable plants.
6. *Note:* Toilets, as plumbing fixtures, are regulated by the Idaho Division of Building Safety, State Plumbing Bureau. Current plumbing code prohibits the use of composting toilets without the permission of the health district. Proof of permission will be provided through a permit issued by the health district.

## 4.5 Drip Distribution System

Revision: August 16, 2018

Installer registration permit: Complex

Licensed professional engineer required: Yes

### 4.5.1 Description

Drip distribution systems are comprised of a shallow network of thin-walled, small-diameter, flexible tubing with self-cleaning emitters to discharge filtered septic tank effluent or pretreated effluent into the root zone of the receiving soils. The drip system is flushed either continuously or noncontinuously depending upon the system design. Minimum system components include, but are not limited to, the following:

1. Septic tank
2. Pretreatment system (not required in gray water system designs or septic tank effluent drip distribution designs):
  - a. Intermittent sand filter
  - b. Recirculating gravel filter
  - c. Extended treatment package system
3. Filtering system (septic tank effluent systems only): spin filters (screen filter), cartridge or disk filters (flushable filter cartridge), and filter flush return line
4. Effluent dosing system: dosing chamber pump, and timed dosing control
5. Process controller: programmable logic controller (PLC)
6. Flow meter
7. Drip tubing network, associated valving, supply line and manifold, pressure regulators (nonpressure compensating emitters only), return manifold and line, and air/vacuum relief valves

### 4.5.2 Approval Conditions

1. Site soil must be one of the approved effective soil design subgroups described in Table 2-4.
2. Site slope may not exceed 45%.
3. All components in contact with wastewater must be rated by the manufacturer for wastewater applications.
4. All pressurized distribution components and design elements of the drip distribution system that do not have design criteria specified within section 4.5 shall follow the design guidance provided in section 4.19.
5. System must be designed by a PE licensed in Idaho.
6. The design engineer shall provide an O&M manual for the system to the health district prior to permit issuance.



### 4.5.3 Design Requirements

Many considerations need to be made in the design of a drip distribution system based on site-, flow-, and effluent-specific characteristics. These characteristics will affect several system components depending on each specific design scenario. The design of a drip distribution system should be approached as an integrated system rather than individual components. System design should account for, but is not be limited to:

1. Tubing material and emitter type
2. Brand of drip tubing to be used and associated proprietary components
3. Level and type of pretreatment to be provided
4. System configuration based on site conditions and constraints
5. Extent of automation, monitoring, and timing of critical operation processes and procedures.

Design requirements vary dependent upon the allowable effluent quality and system flushing. Requirements based on these system parameters are included in the subsequent sections.

#### 4.5.3.1 Basic Design Requirements

The following minimum design elements apply to both septic tank and pretreated effluent systems and continuous and noncontinuous flush drip distribution systems:

1. Drip distribution tubes are placed directly in approved native soil at a depth of 6–18 inches with a minimum final cover of 12 inches.
2. Drip distribution tubes should be placed on contour and slightly slope towards the manifold for proper drainage.
  - a. Installations on slopes must account for depressurization flow and be designed to prevent movement of the wastewater to the bottom of the drip distribution zone during this time.
  - b. Manifold design must allow for all the associated drip tubing to drain back to the manifold and prevent wastewater from drip tubing at higher elevations from draining into drip tubing at the lowest elevations.
3. A minimum of two zones are recommended, but not required, regardless of system size, and zones should be kept as small as is reasonable.
  - a. Individual lateral lengths should be designed to provide equal discharge volumes across the lateral emitters (lateral length is calculated from the connection point on the supply line to the connection point on the return line).
  - b. Lateral lengths may differ within a zone as long as the minimum flushing velocity can be maintained at the terminal end of each lateral.
  - c. Zones within a system should be close to equal in size to achieve efficient and consistent application of wastewater.
  - d. In lower permeability soils (i.e., clayey soils), it is recommended that drip tubing and emitter spacing be reduced while maintaining the minimum square footage to increase the emission points and maintaining the dosing volume to decrease wastewater travel distance through the soil.

4. The design application rate is based on the most restrictive soil type encountered within the minimum effective depth of soil below the drip distribution tubing required to meet the necessary separation distance to limiting layers.
5. Septic tank effluent drip distribution systems are required to be adequately filtered with a 100–115 micron or smaller spin/screen filters or disk filters that are flushable or nonflushable before discharge into the drip distribution tubing network. Filters are not required for pretreated effluent drip distribution systems but are recommended.
6. When installed, effluent filters are required to be:
  - a. Automatically backflushed to flush the solids off the filter surface and return them to the inlet pipe of the septic tank, or
  - b. Inspected periodically and hand cleaned if necessary.
7. A minimum of two vacuum relief valves are required per zone.
  - a. The valves are located at the highest points on both the distribution and return manifolds.
  - b. Vacuum relief valves are located in a valve box that is adequately drained and insulated to prevent freezing.
8. Pressure compensating emitters shall be used in all drip distribution installations.
10. The hydraulic design of the drip distribution system should achieve discharge rates and volumes that vary no more than  $\pm 10\%$  between all the emitters within a zone during a complete dosing event.
  - a. Consideration should be given to the unequal distribution during flow pressurizing and depressurizing periods.
  - b. The designer must be able to mathematically support the design for equal distribution.
10. Dosing requirements in all drip distribution systems include the following:
  - a. Timed dosing is required.
  - b. Dosing will only occur when the dosing chamber has sufficient volume to deliver a full design dose to the drip distribution system.
  - c. Sufficient rest time shall be programmed to provide time for effluent to distribute away from the drip lines.
  - d. Shall include a flow meter or run time/event counter.
  - e. The capability to monitor flow rates both during dosing and flushing events.
  - f. Small, frequent doses should be avoided and dose volumes should be several times the total supply and return manifold and drip tubing volumes within the dosing zone.
11. Dosing chambers shall provide sufficient storage for equalization of peak flows and meet the requirement of section 4.19.3.3.2 and 4.19.3.4.
12. Each valve, filter, pressure regulator, and any other nondrip tube or piping component is required to be accessible from grade and should be insulated to prevent freezing.

#### **4.5.3.2 Additional Design Requirements for Septic Tank Effluent Drip Distribution Systems**

Septic tank effluent drip distribution systems discharge filtered effluent that has only passed through an appropriately sized septic tank, dosing chamber, and 100–115 micron filters before

entering the drip distribution tubing. The following additional minimum design elements apply only to septic tank effluent drip distribution systems:

1. Effective soil depth to limiting layers below the drip tubes shall meet the minimum depths specified in IDAPA 58.01.03.008.02.c (section 7.1) for daily design flows <2,500 gallons per day (GPD) or IDAPA 58.01.03.013.04.c (section 7.1) for daily design flows  $\geq 2,500$  GPD.
2. Total drip distribution area shall be determined by dividing the daily design flow by the soil application rates in Table 2-4.
3. Minimum drip tubing length that must be installed shall be determined by dividing the total drip distribution area by 2.
  - a. The minimum tubing length and drip tube spacing must create a system layout that equals or exceeds the total drip distribution area calculated in 2.
  - b. It is recommended that extra tubing be included in the system design for systems being placed in soil design group C soils.
4. Drip distribution tubes may be placed on a minimum of 2-foot centers.
5. Emitter spacing may be a maximum of 12 inches.
6. Emitter flow rate shall be  $\leq 0.6$  gallons per hour.
7. Filters shall be back flushed at the start of each dosing cycle, and zones should be flushed every 20–50 dosing cycles with a minimum fluid velocity of 2 feet per second designed at the distal end of the lateral connection.

#### **4.5.3.3 Additional Design Requirements for Pretreated Effluent Drip Distribution Systems**

Pretreated effluent drip distribution systems discharge effluent that has passed through an appropriately sized septic tank, pretreatment system, and dosing chamber before entering the drip tubing. The following additional minimum design elements apply only to pretreated effluent drip distribution systems:

1. Effective soil depth to limiting layers below the drip tubes shall meet the minimum depths specified in section 4.21.5, Table 4-21.
2. Total drip distribution area shall be determined by dividing the daily design flow by the soil application rates in Table 4-22.
3. Minimum drip tubing length that must be installed shall be determined by dividing the total drip distribution area by 2.
  - a. The minimum tubing length and drip tube spacing must equal or exceed the total drip distribution area calculated in 2.
  - b. It is recommended that extra tubing be included in the system design for systems being placed in soil design group C soils.
4. Drip distribution tubes may be placed on a minimum of 2-foot centers.
5. Emitter spacing may be a maximum of 24 inches.
6. Emitter flow rate shall be  $\leq 1.1$  gallons per hour.
7. If filters are flushed, it is recommended that frequency be once per week.
8. Drip distribution zones should be flushed every 2 weeks.

#### **4.5.3.4 Additional Design Requirements for Noncontinuous Flush Drip Distribution Systems**

The following additional minimum design elements apply only to noncontinuous flush drip distribution systems:

1. In noncontinuous flush systems, drip distribution laterals are flushed at regular intervals, but at least every 2 weeks, to prevent biofilm and solids buildup in the tubing network.
  - a. Minimum flushing velocity is based on the tubing manufacturer's recommendations for the return ends of the distribution lines and in the drip distribution tubing during field flush cycles; must be high enough to scour the drip distribution tubing; and is recommended to exceed the manufacturer's recommended velocity.
  - b. The minimum flushing duration is long enough to fill all lines and achieve several pipe volume changes in each lateral.
2. In noncontinuous flush systems, the return manifold is required to drain back to the dosing chamber.
3. In noncontinuous flush systems, timed or event-counted backflushing of the filters is required when filters are installed.
4. In noncontinuous flush systems, filters (when installed), flush valves, and a pressure gauge shall be placed in a head works (between the dose pump and drip field) and on the return manifold.

#### **4.5.3.5 Additional Design Requirements for Continuous Flush Drip Distribution Systems**

The following additional minimum design elements apply only to continuous flush drip distribution systems:

1. If flushing filters are installed, then they shall be backwashed according to the manufacturer's recommendations, and the process must be automated.
2. Drip distribution laterals are flushed during the dosing cycle.
  - a. The continuous flush system must be designed to the manufacturer's minimum recommended flow velocity, must be high enough to scour the drip distribution tubing, and is recommended to exceed the manufacturer's recommended velocity.
  - b. The dose duration must be long enough to achieve several pipe volume changes in each drip tubing lateral to adequately accomplish flushing the drip tubing lines.
3. Filters (when used) and pressure gauges may be placed in a head works (between the dose tank and drip distribution tubing).
4. Supply and return pressure gauges are needed to ensure that the field pressurization is within the required range specified by the drip tube manufacturer.
5. In continuous flush systems, both supply and return manifolds are required to drain back to the dosing chamber.
6. Due to the nature of the continuous flush process, the filter shall be examined after initial start-up and cleaned if necessary to prevent incorrect rate of low readings for the controller.

7. The drip distribution system will operate to the manufacturer's minimum recommended flow velocity for the duration of each cycle, and the total flow minus the emitter uptake flow would be the return and flushing flow.

#### 4.5.4 Construction

1. No wet weather installation is allowed.
2. Excavation and grading must be completed before installing the subsurface drip distribution system.
3. Drip distribution tubing may be installed using a trencher, static plow, or vibratory plow.
  - a. Care must be taken when using a trencher to ensure the tubing is in contact with the trench bottom and does not have many high and low points in the line.
  - b. Trenchers may limit the potential for smearing in clay soils.
  - c. When using a static or vibratory plow, care must be taken to ensure the drip distribution tubing does not snag and stretch when unrolling.
  - d. Use of a gage wheel with a static plow will assist in installing tubing to grade on level sites.
  - e. Vibratory plows allow for minimal site disturbance and may be best for cutting through roots in the soil.
4. Drip distribution systems may not be installed in unsettled fill material.
5. No construction activity or heavy equipment may be operated on the drip distribution area other than the minimum to install the drip distribution system.
6. Do not park or store materials on the drip distribution area.
7. For freezing conditions, the bottom drip distribution line must be higher than the supply and return line elevation at the dosing chamber.
8. All PVC pipe and fittings shall be PVC schedule 40 type 1 or higher rated for pressure applications.
9. Flexible PVC pipe should be used for connecting individual drip lines together when making turns in laterals and may be used for connecting drip laterals to supply and return manifolds.
10. All glued joints shall be cleaned and primed with purple (dyed) PVC primer before being glued.
11. All cutting of PVC pipe, flexible PVC, or drip tubing should be completed using pipe cutters.
12. Sawing PVC, flexible PVC, or drip distribution tubing is allowed only if followed by cleaning off any residual burs from the tubing or pipe and removing all shavings retained in the tubing or pipe.
13. All open PVC pipes, flexible PVC, or drip distribution tubing in the work area shall have the ends covered during storage and construction to prevent construction debris and insects from entering the tubing or pipe.
14. Before gluing, all glue joints and tube or pipe interior shall be inspected and cleared of construction or foreign debris.

15. Dig the return manifold trench along a line marked on the ground and back to the dosing chamber.
  - a. The return manifold trench should start at the farthest end of the manifold from the dosing chamber.
  - b. The return manifold must slope back to the dosing chamber.
16. Before start-up of the drip distribution system, the air release valves shall be removed and each zone in the system shall be flushed as follows:
  - a. System flushing is accomplished by the manufacturer or engineer using the control panel's manual override.
  - b. Use an appropriate length of flexible PVC pipe with a male fitting and attach it to the air release connection to direct the flush water away from the construction and drip distribution system area.
  - c. Flush each zone with a volume of clean water at least two times the volume of all piping and tubing from the dosing chamber to the air release valve with the zone being flushed.

*Note:* filters are not backflushed during start-up as any clogging could cause incorrect rate of flow readings for the controller.
17. If existing septic tanks or dosing chambers are to be used, they shall be pumped out by a permitted septic tank pumper, checked for structural or component problems, and repaired or replaced if necessary.
  - a. After a tank is emptied, the tank shall be rinsed with clean water, pumped again, refilled with clean water, and leak tested.
  - b. Debris in any tank should be kept to a minimum because it may clog the filters during start-up.
18. Once completed, cap the drip distribution areas for shallow installations (less than 12 inches) with 6–8 inches of clean soil and suitably vegetate.
  - a. Cap fill material shall be the same as or one soil group finer than that of the site material, except that no fill material finer than clay loam may be used.
  - b. Cap fill shall be free of debris, stones, frozen clods, or ice.
  - c. The cap should be crowned to promote drainage of rainfall or runoff away from the drip area.
  - d. Suitable vegetation should consist of typical lawn grasses or other appropriate low-profile vegetation that will provide thermal insulation in cold climates.
  - e. Trees, shrubs, and any other vegetation that aggressively seeks water should not be planted within 50 feet of the drip tubing network.
19. Development of a diversion berm around the drip distribution area will aid in the diversion of runoff around the system.

#### 4.5.5 Inspection

1. A preconstruction meeting between the health district, responsible charge engineer, and installer should occur before commencing any construction activities.

2. The health district shall inspect all components and fill material used in constructing the drip distribution system before backfilling or cap fill placement.
3. The responsible charge engineer should conduct as many inspections as necessary to verify system and component compliance with the engineered plans.
4. The responsible charge engineer shall provide the health district with a written statement that the system was constructed and functions in compliance with the approved plans and specifications. Additionally, the responsible charge engineer shall provide as-built plans to the health district if any construction deviations occur from the permitted construction plans. (IDAPA 58.01.03.005.15)

#### 4.5.6 Operation and Maintenance

1. The drip distribution system design engineer shall provide a copy of the system's OMM procedures to the health district as part of the permit application and prior to subsurface sewage disposal permit issuance (IDAPA 58.01.03.005.04.k).
2. Minimum OMM requirements should follow each system component manufacturer's recommendations.
  - a. Monitoring should be based on the most limiting process in the system design.
  - b. Regular monitoring of flow rates and pressures should be specified to diagnose possible overuse.
3. Additional OMM may be required for the pretreatment component of the drip distribution system.
  - a. The minimum OMM of the pretreatment component will be based on the manufacturer's recommendations and the minimum requirements specified within this manual for the specific pretreatment system.
  - b. Additional OMM may be based on specific site conditions or pretreatment component type.

#### 4.5.7 Suggested Design Example

1. Determine square feet needed for the septic tank effluent drip distribution system, as follows.
  - a. Wastewater flow in GPD is divided by the soil application rate (based on the soil classification from an on-site evaluation).
  - b. Result is the square feet (ft<sup>2</sup>) needed for the system.

Example conditions: three-bedroom home discharging pretreated effluent in subgroup C-2 soils.

Example calculation:  $(250 \text{ GPD}) / (0.2 \text{ gallons/ft}^2) = 1,250 \text{ ft}^2$

2. System design will use an application area of 2 ft<sup>2</sup>/ft of drip distribution tube. Divide the required square feet by the drip distribution tube application area (2 ft<sup>2</sup>/ft). This will determine the minimum length of drip distribution tube needed for the system.

Example:  $(1,250 \text{ ft}^2) / (2 \text{ ft}^2/\text{ft}) = 625 \text{ feet of drip tube}$

3. Determine pumping rate by finding the total number of emitters and multiplying by the flow rate per emitter (0.9 gallons/hour/emitter at 20 psi). Adjust output to GPM and add

1.5 GPM per connection for flushing to achieve, for example, a 2 feet/second flushing velocity.

*Note:* For continuous flush systems, the number of emitters will vary depending on the product selected.

Example:  $(625 \text{ feet}) / (2 \text{ feet/emitter}) = 312.5$ , use 313 emitters

$(313 \text{ emitters}) \times (0.9 \text{ gallons/hour/emitter}) = 281.7 \text{ gallons/hour}$

$(281.7 \text{ gallons/hour}) / (60 \text{ minutes/hour}) = 4.695 \text{ GPM}$ , or 5 GPM

10 connections at 1.5 GPM per connection = 15 GPM

Pumping rate: 5 GPM + 15 GPM = 20 GPM

4. Determine feet of head. Multiply the system design pressure (20 psi for this example—values can vary depending on the drip distribution tube used) by 2.31 feet/psi to get the head required to pump against.

Example:  $(20 \text{ psi}) \times (2.31 \text{ feet/psi}) = 46.2 \text{ feet of head}$

Add in the frictional head loss from the drip distribution tubing and piping.

5. Select a pump. Determine the size of the pump based on gallons per minute (step 3 of suggested design example) and total head (step 4 of suggested design example) needed to deliver a dose to the system. The pump selected for this example must achieve a minimum of 20 GPM plus the flush volume at 46.2 feet of head.

Figure 4-7 shows an overhead view of a typical drip distribution system. Figure 4-8 shows a potential layout of a filter, valve, and meter assembly, and Figure 4-9 illustrates a cross-sectional view of the filter, valve, and meter assembly. Figure 4-10 provides a view of the continuous flush system filter and meter assembly.



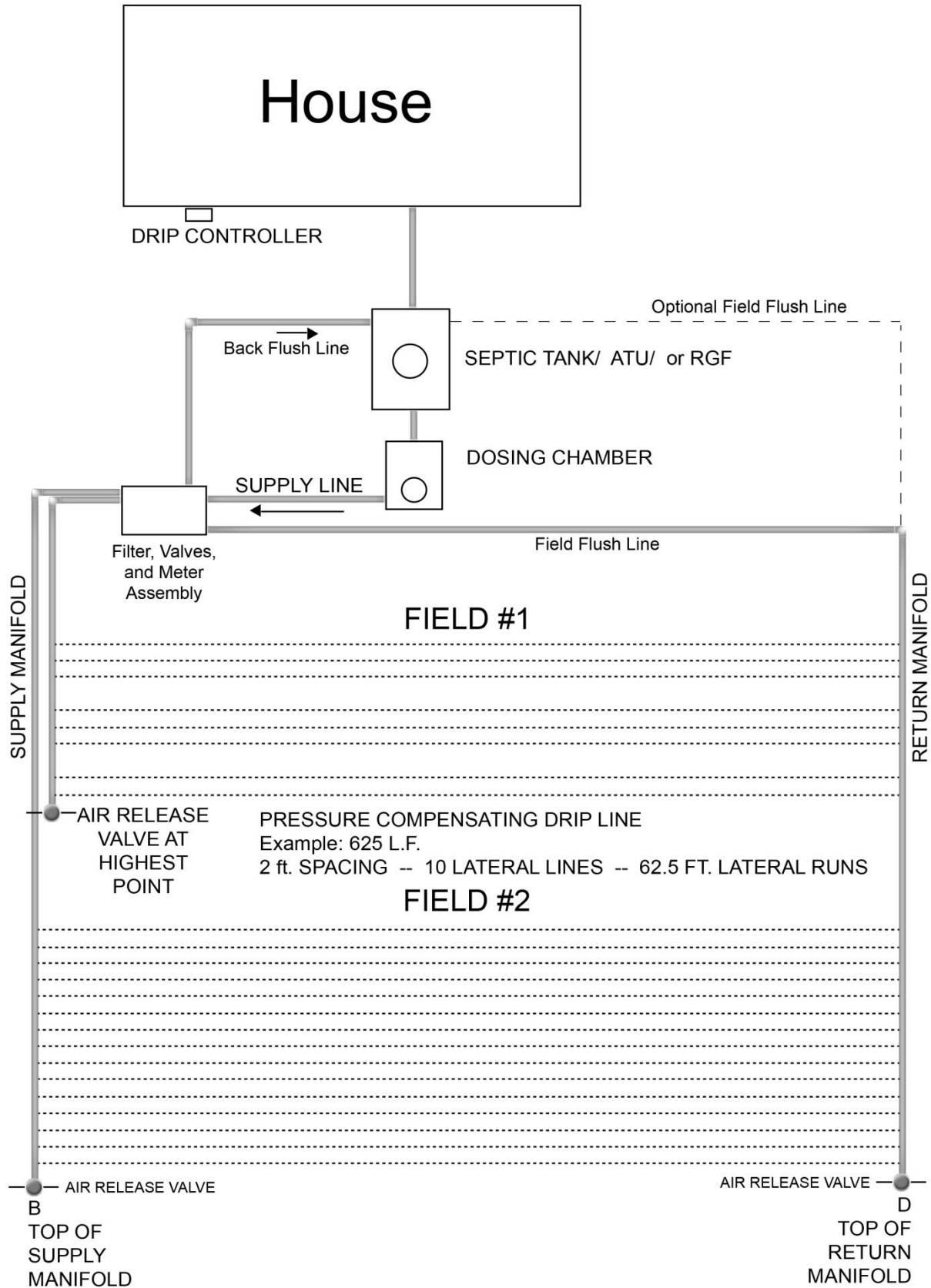

**Figure 4-7. Overhead view of typical drip distribution system.**

Controlled Document—Users are responsible for ensuring they work to the latest approved revision. Printed or electronically transmitted copies are uncontrolled.

## Valve Box Examples

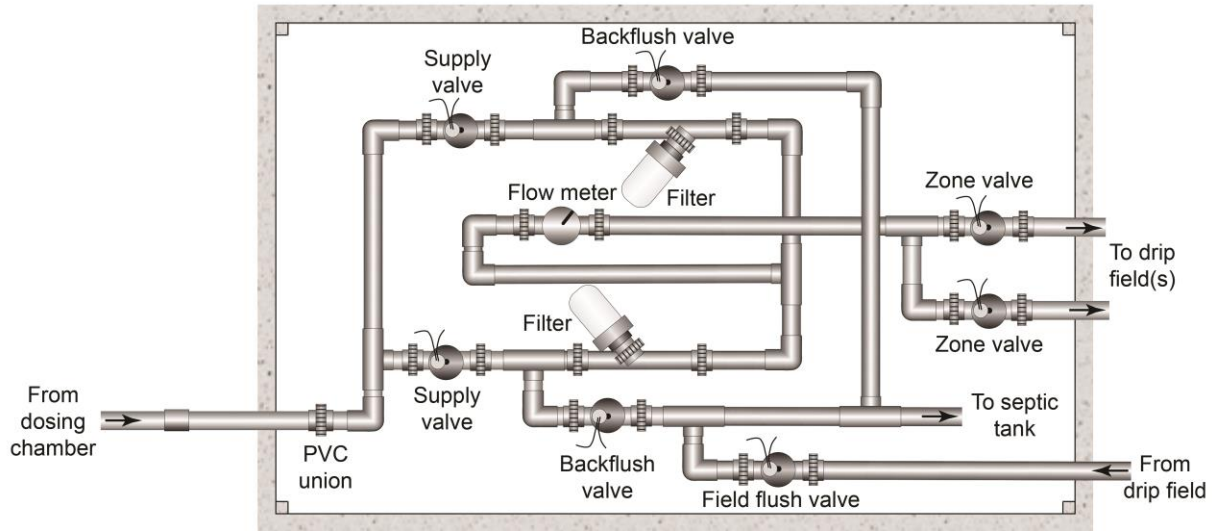

Figure 4-8. Overhead view of filter, valve, and meter assembly for a noncontinuous flush system.

## Valve Box

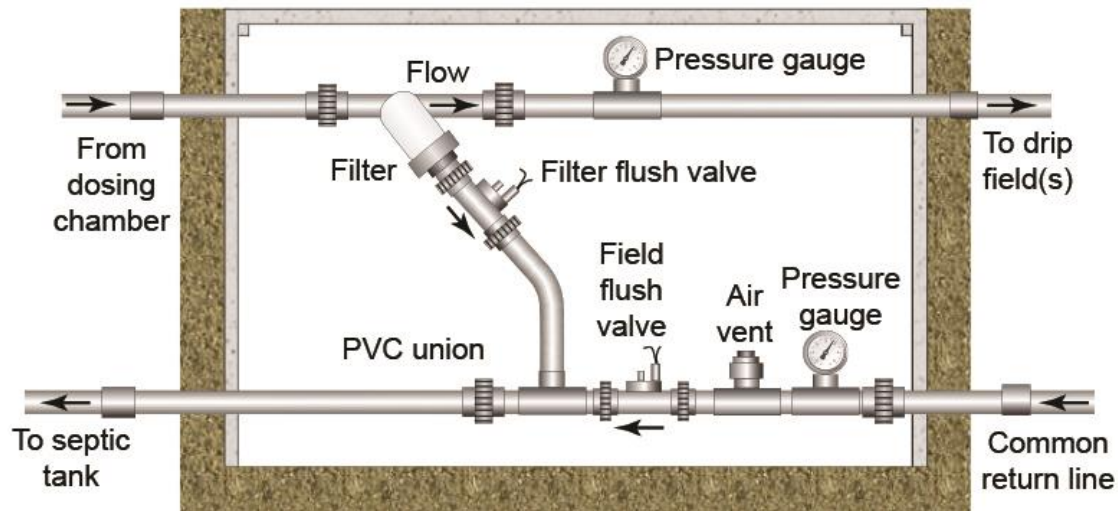

Figure 4-9. Cross-sectional view of typical filter, valve, and meter assembly for a noncontinuous flush system.

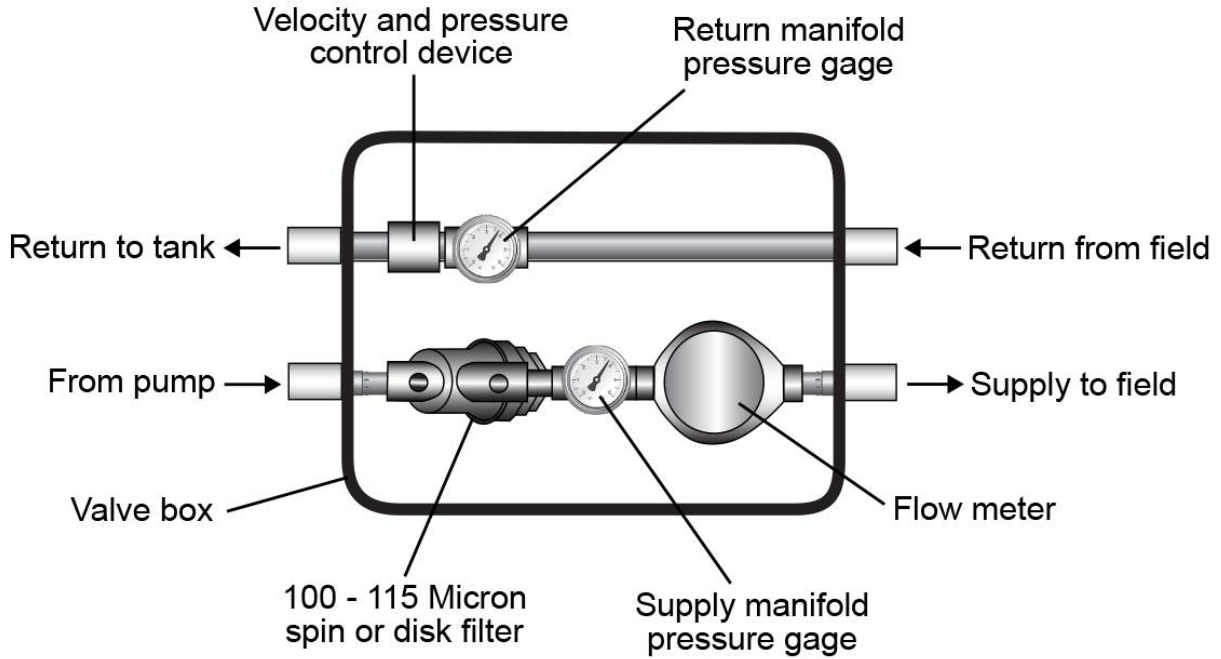

Figure 4-10. Overhead view of continuous flush system filter and meter assembly.

## 4.6 Evapotranspiration and Evapotranspiration/Infiltrative Systems

Revision: July 9, 2012

Installer registration permit: Complex

Licensed professional engineer required: Yes

### 4.6.1 Description

An evapotranspiration (ET) system is composed of a sand and gravel bed contained within an impervious lining, which receives septic tank effluent and in which evaporation through the system's surface and plant transpiration are the sole means of effluent removal. All forms of ET systems function best where the climate is dry and hot. Preferably, the difference between the site precipitation and evapotranspiration provides water loss of 2 inches per month on average.

An ET system that allows some wastewater to infiltrate the subsurface can be allowed under the proper site conditions and source attributes. This is an evapotranspiration infiltrative (ETI) system. An ETI system has more restrictive site and design constraints because of the additional wastewater discharge path into the surrounding soils.

Due to the complex water balance calculations for system sizing, coupled with liner design and construction details, these systems must be designed by a PE licensed in Idaho, or professional geologist (PG). Construction requires the services of a licensed Complex Alternative System Installer as specified in IDAPA 58.01.03.006.01.b.

Because of the impermeable liners, ET systems are classified among the non-discharging wastewater systems. This is different from ETI systems, which discharge a small amount of wastewater to the soil. Sites with soils that have percolation rates greater than 120 minutes/inch ( $3.5 \times 10^{-4}$  centimeters per second [cm/s]) and have site attributes that meet both the minimum vertical and minimum horizontal setback distances for design group C soils may be suitable for installation of a properly designed and constructed ETI system.

### 4.6.2 Approval Conditions

1. The site must not be subject to flooding.
2. Ground water
  - a. For ET systems, high ground water, seasonal or normal, must not come within 6 inches of the bottom of the impervious liner.
  - b. For ETI systems, vertical separation distances must meet the minimum distance requirement for design group C soils (section 2.2.2, Table 2-5).
3. Soil
  - a. ET systems may be approved where soils:
    - 1) Are very thin
    - 2) Are classified unsuitable as defined in IDAPA 58.01.03.008.02.b.
  - b. ETI systems are restricted to sites with soils that are classified as *Unsuitable* through use of the soil texture determination flowchart (section 2.1.1, Figure 2-2), exhibit unacceptably low infiltration (section 2.1.2, Table 2-4), and the site attributes meet

- design subgroup C-2 soil depth requirements (section 2.2.2, Table 2-5). Unacceptably low infiltration rate soils have percolation rates greater than 120 minutes/inch ( $3.5 \times 10^{-4}$  cm/s) (section 2.1.2, Table 2-4).
4. The adjusted growing season (March–October) site evapotranspiration must exceed the 10-year return frequency annual precipitation. Some sites may have attributes that provide evapotranspiration losses year-round. These beneficial site attributes may allow an ET or ETI system to be sized based on annual evapotranspiration rates (January–December). Permit applications proposing use of annual evapotranspiration must document the site attributes that justify this alteration. Attributes that may qualify a site for annual evapotranspiration losses include but are not necessarily limited to:
    - a. Site receives full sun exposure year-round.
    - b. Site has a growing season exceeding 210 days.
    - c. Site lacks features causing snow drifts to settle over the system.
    - d. System uses cool season growing grasses and other plants  
<http://www.hort.purdue.edu/newcrop/afcm/grassseed.html>.
  5. The slope must not exceed 12%.
  6. The setback distance from surface water for ET systems may be reduced to 100 feet if the system is constructed with a minimum of a 30-mil (0.030-inch) PVC or 60-mil (0.060-inch) high-density polyethylene (HDPE) liner. Horizontal setback distances to surface water for an ETI system must adhere to those for design group C soils (100 feet per IDAPA 58.01.03.008.02.d).
  7. Both ET and ETI systems must have a minimum 100 feet of separation to any domestic or public well.
  8. ETI systems may require an augmented soil liner to limit infiltration and ensure proper system function when the soils exhibit moderate-to-strong vertical soil structure or are very gravelly or very stony. Infiltration should be limited to no more than 10% of the home's wastewater flow. Infiltration rates of 85,000 minutes/inch ( $5 \times 10^{-7}$  cm/s) or more will typically be needed to inhibit wastewater infiltration sufficiently for proper system operation. This restriction is required to balance water losses before system maturation. At system maturation, a fully developed biomat will further inhibit wastewater infiltration into the soil and allow the ETI system to operate using evaporation and plant transpiration.
  9. The soil's infiltration rate will need to be determined. Table 4-5 identifies acceptable soil infiltration specifications depending on soil type and configuration. Soils with infiltration rates greater than  $5 \times 10^{-7}$  cm/s (85,000 minutes/inch) will need to have an augmented soil liner.

**Table 4-5. Dual ring infiltrometer testing specifications.**

Soils Type	ASTM Method	Soil Infiltration Rates (cm/s)
Coarse sand to unsuitable clayey soils	ASTM D3385	$1 \times 10^{-2}$ to $1 \times 10^{-6}$
Amended soil and compacted clay liners	ASTM D5093	$1 \times 10^{-5}$ to $1 \times 10^{-7}$

Notes: American Society for Testing and Materials (ASTM); centimeters per second (cm/s)

### 4.6.3 System Design Criteria

- Equation 4-1 gives the calculation for horizontal area.

$$(a) \text{ ET system: } T_{ET\text{area}} = \frac{nV}{(GS_{ET} - P)} \qquad (b) \text{ ETI system: } T_{ETI\text{area}} = \frac{nV}{(GS_{ET} + I - P)}$$

**Equation 4-1. ET and ETI system horizontal area in square feet.**

where:

$T_{ET\text{area}}$  and  $T_{ETI\text{area}}$  = total horizontal area in square feet (ft<sup>2</sup>).

$n$  = peaking factor, varies from 1 to 1.6, per EPA/625/R-00/008, TFS-31 (EPA 2002).

$V$  = annual volume of received effluent, in cubic feet (ft<sup>3</sup>).

$GS_{ET}$  = annual growing season (March–October) reference evapotranspiration, adjusted for the vegetation planted on the bed, in feet. Suitable sites may use annual (January–December) plant-specific reference evapotranspiration values, in feet.

$P$  = annual precipitation, in feet, with a return frequency of 10 years.

$I$  = annual infiltration volume, in ft<sup>3</sup>.

- Total bed depth ( $D_{\text{bed}}$ ) will be determined from a water mass balance beginning in October (Table 4-6). Credit for evaporation occurring between November and February may be allowed on a site-specific basis as specified in approval condition 4. Total bed depth criteria include the following:

*Note:* See Figure 4-11 for a cross section of the evapotranspiration system.

- Total vertical distance from the ground surface to the impermeable liner, for an ET system, or to the bottom of the excavated native soil, for an ETI system, should not exceed 4 feet.
- Vertical distance from the ET or ETI bed’s surface to the top of the distribution laterals must be 1 foot.
- Vertical distance from the top of the laterals to the highest saturated effluent elevation should be no less than 0.5 feet.

**Table 4-6. Water mass balance for an ET or ETI system.**

Month	A Precipitation Rate	B Effluent Depth	C Evapo- transpiration	D Infiltration (ETI only)	E Change ( $\Delta$ ) in Storage	F Cumulative Storage	G Saturated Bed Depth
Oct.							
Nov.							
Dec.							
Jan.							
Feb.							
March							
April							
May							
June							
July							
Aug.							
Sept.							

3. One or more standpipes are required to provide access for operations and maintenance activities, troubleshooting, and installation of a high-water alarm.
4. A high-water alarm is required. This high-water alarm shall indicate when the effluent level in the ET or ETI system reaches the bottom of the laterals, which indicates that the system is malfunctioning or is overloaded. The alarm shall be both audible and visible. The alarm relay shall be latching, which requires the owner, operator, or service personnel to physically inspect the effluent level, take corrective action, and reset the alarm.

#### 4.6.4 System-Sizing Procedure

1. Determine annual precipitation with a 10-year return frequency. Start with annual precipitation data in feet per month from the Desert Research Institute, Idaho Climate Summaries at <http://www.wrcc.dri.edu/summary/climsmid.html>. Perform a frequency analysis using the log Pearson III method described at <http://water.oregonstate.edu/streamflow/analysis/floodfreq/index.htm#log>. A web-based calculator for this method can be found at <http://onlinehydro.sdsu.edu/onlinepearson2.php>.

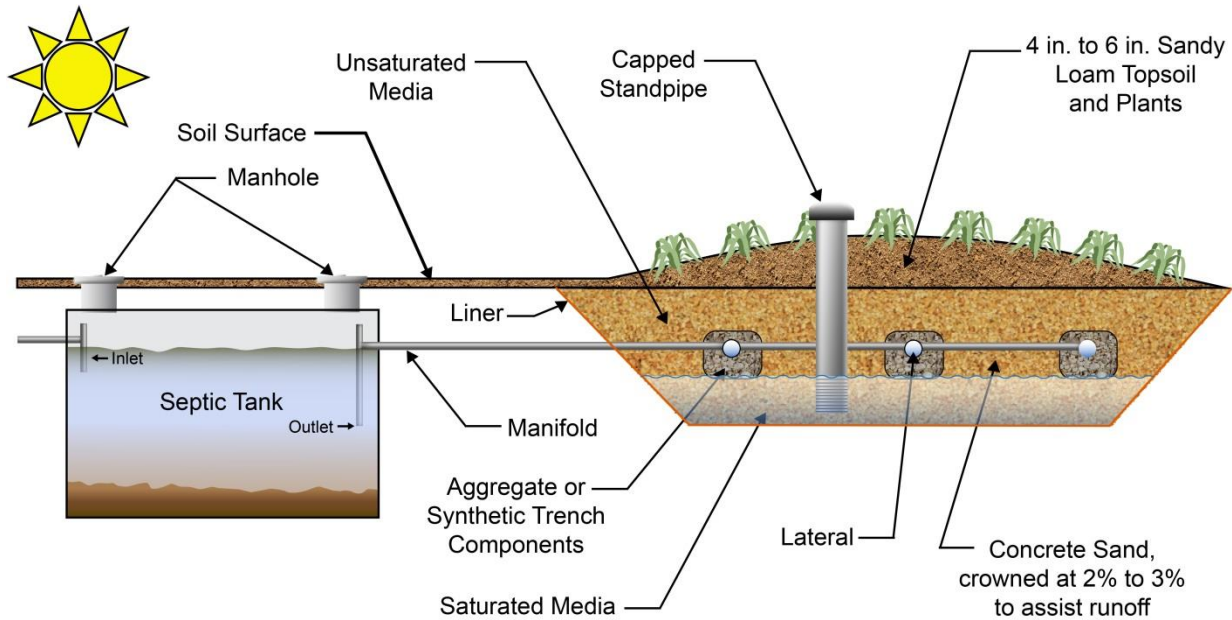

**Figure 4-11. Cross section of evapotranspiration system.**

2. Determine the Monthly Precipitation Contribution (MPC). The MPC is calculated by dividing a month’s long-term monthly average for the climatological site in question by the long-term average annual precipitation for that site. The MPC values multiplied by the 10-year return frequency annual precipitation will yield the monthly precipitation rates. Record these monthly precipitation values in Table 4-6, column A.
3. Calculate the monthly effluent depth, in cubic feet per month per square foot of surface area, by using Equation 4-2. Record the monthly effluent depth in Table 4-6, column B.

$$B = \frac{X \text{ Gallons/Day} * Y \text{ Days/Month} * 0.1337 \text{ ft}^3/\text{Gallon}}{T_{\text{area}} \text{ ft}^2}$$

**Equation 4-2. ET and ETI vertical effluent depth (feet).**

where:

$T_{\text{area}}$  (ft<sup>2</sup>) is the area derived from Equation 4-1 (a), for an ET system, or Equation 4-1 (b), for an ETI system.

4. Determine evapotranspiration in feet per month from the average growing season (March–October) reference evapotranspiration (ET<sub>r</sub>) rate for the weather station nearest the proposed project. Resources that provide this information include the AgriMet Agricultural Weather Network at <http://www.usbr.gov/pn/agrimet/monthlyet.html> and the University of Idaho, Kimberly Research and Extension Center at <http://www.kimberly.uidaho.edu/ETIdaho/>.

The ET<sub>r</sub> value may need to be adjusted for the water use efficiency of typical plant species used on the ET bed; this is done by multiplying the ET<sub>r</sub> value by a crop coefficient of 0.7. Equation 4-3 shows this calculation. If the University of Idaho Kimberly ET<sub>pot</sub> dataset for grasses is used, and the system is to be covered with grass, then the crop coefficient need not be used. Record the monthly adjusted ET<sub>r</sub> or ET<sub>pot</sub> values in Table 4-6, column C.



$$C = 0.7 * ET_r \quad \text{Equation 4-3. Plant water efficiency adjustment}$$

or

$$C = ET_{pot}$$

5. For ETI systems, calculate the amount of wastewater that is allowed to infiltrate the soil each month. This amount will not be allowed to exceed 10% of the monthly wastewater contribution. The infiltrative loss is restricted to 10% to assist the ETI system in developing a biomat within the first year. Any greater infiltration rate will allow large fluctuations in the ETI system effluent level, thereby inhibiting biomat development and yielding an undersized system once the biomat is established. A mature ETI system will have a biomat that inhibits effluent infiltration, limiting a mature system to using the soil evaporation and plant transpiration to function properly. Limiting monthly discharges to the soil to 10% of the monthly wastewater volume will also ensure that the system size is large enough to function properly when it has a mature biomat inhibiting infiltration. Record these monthly infiltration values in Table 4-6, column D.
6. Determine the change in the system's effluent depth (both ET and ETI). To calculate the change in storage use the values previously recorded in Table 4-6 in the appropriate column (e.g., effluent depth in column B, evapotranspiration in column C, etc.).
  - a. For ET systems,  $\Delta$  storage = effluent depth + [precipitation - evapotranspiration<sub>adjusted</sub>]
  - b. For ETI systems,  $\Delta$  storage = effluent depth + [precipitation - ET<sub>r adjusted</sub>] - infiltration
  - c. Calculate the change in storage (E) using Equation 4-4 and record monthly change in storage values in Table 4-6, column E.

$$E_{Mar} = B_{Mar} + A_{Mar} - C_{Mar} - D_{Mar} \quad \text{Equation 4-4. ET and ETI system monthly storage depth (feet)}$$

$$E_{Apr} = \dots$$

$$E_{Oct} = B_{Oct} + A_{Oct} - C_{Oct} - D_{Oct}$$

7. Determine the cumulative storage for each month by adding the change in storage for that month and the previous month's cumulative storage, as shown in Equation 4-5. Calculate the cumulative storage (F) using Equation 4-5. These values are found in Table 4-6, columns E and F. Record the cumulative storage values in Table 4-6, column F.

$$F_{Oct} = E_{Oct} \quad \text{Equation 4-5. ET system cumulative storage depth (feet)}$$

$$F_{Nov} = F_{Oct} + E_{Nov}$$

$$F_{Dec} = F_{Nov} + E_{Dec}$$

...

$$F_{Sept} = F_{Aug} + E_{Sept}$$

8. Determine the total bed depth required to prevent overflow. Since the bed is filled with concrete sand, the total bed is not available for storage. An acceptable value for sand

porosity is 35% (0.35). Calculate the saturated bed depth (G) using Equation 4-6. Record the saturated bed depth values in Table 4-6, column G.

$$G_{Oct} = \frac{F_{Oct}}{0.35}$$

...

$$G_{Sept} = \frac{F_{Sept}}{0.35}$$

**Equation 4-6. ET system saturated bed depth (feet)**

Select  $G_{max}$ , the largest value of saturated bed depths in Table 4-6, column G. This is the maximum effluent depth that the system will experience during the annual cycle.

9. Finally, calculate the total bed depth,  $D_{bed}$ , by adding 1.5 feet, as specified in section 4.6.3(2), to the maximum saturated bed depth ( $G_{max}$ ). If the total bed depth is greater than 4 feet, then the area of the ET/ETI bed should be increased to add the volume required to keep the ET/ETI bed maximum depth at 4 feet or less.

If site and climate constraints warrant, the system’s bed depth may be increased to no greater than 6 feet from the system’s surface; this may be accomplished by placing the bottom of excavation at 4 feet below the ground surface and then mounding the system above the ground surface. In such cases, the system liner is required to be extended above the ground surface, adequately secured to retain all effluent, and covered with topsoil. A pump may be required to lift the septic tank effluent up into the laterals in the bed.

#### 4.6.5 Construction

1. To provide primary clarification, an appropriately sized septic tank must be placed prior to the ET or ETI system. Septic tanks must meet the volume requirements specified in IDAPA 58.01.03.007.07.a.
2. Lining
  - a. An ET system must be lined with an impervious liner approved by DEQ. Synthetic liners must be placed on at least 4 inches of concrete sand bedding that is free of sharp stones. The liners must be bonded per manufacturer’s recommended procedures. Leak testing, as specified in section 4.6.6, is required.
  - b. An ETI system may need soil augmentation to decrease the infiltration rate to a value that allows no more than 10% of the daily wastewater volume to disperse into the underlying soils. Soil augmentation may be achieved by compaction, bentonite clay augmentation, or addition of soil-cement. In all instances, the liner must be designed, and construction overseen, by a PE or PG licensed in Idaho.
3. The bed should be filled with concrete sand. The sand should be crowned at 2%–3% to establish a slope for precipitation and snow melt runoff.
4. Distribution laterals may be placed in drainrock trenches that measure 1 x 1 foot and are constructed in the concrete sand layer, or may be constructed with gravelless trench components. The piping should be looped, and spaced to provide uniform effluent distribution (Figure 4-11).

5. The drainrock trenches shall be wrapped in geotextile fabric to keep the concrete sand from migrating into the void spaces provided by the drainrock.
6. A 4- to 6-inch layer of sandy loam topsoil must be placed directly on the concrete sand bed, matching the slope specified for the concrete sand.
7. An 8-inch minimum diameter standpipe shall be installed in the center of the bed. The standpipe shall extend down to the splash plate and up above the topsoil a minimum of 6 inches. The purpose of the standpipe is to monitor effluent levels in the bed, provide access for maintenance pumping to reduce the salinity levels in the bed, and provide access for emergency situations to prevent surfacing of effluent. If the ET or ETI system has an aspect ratio (AR), which is the ratio of length (L) to width (W), greater than two, then multiple standpipes will be required. The distance between any two standpipes should be approximately the width of the system. This may result in multiple standpipes. Figure 4-12 provides suggested standpipe configurations.

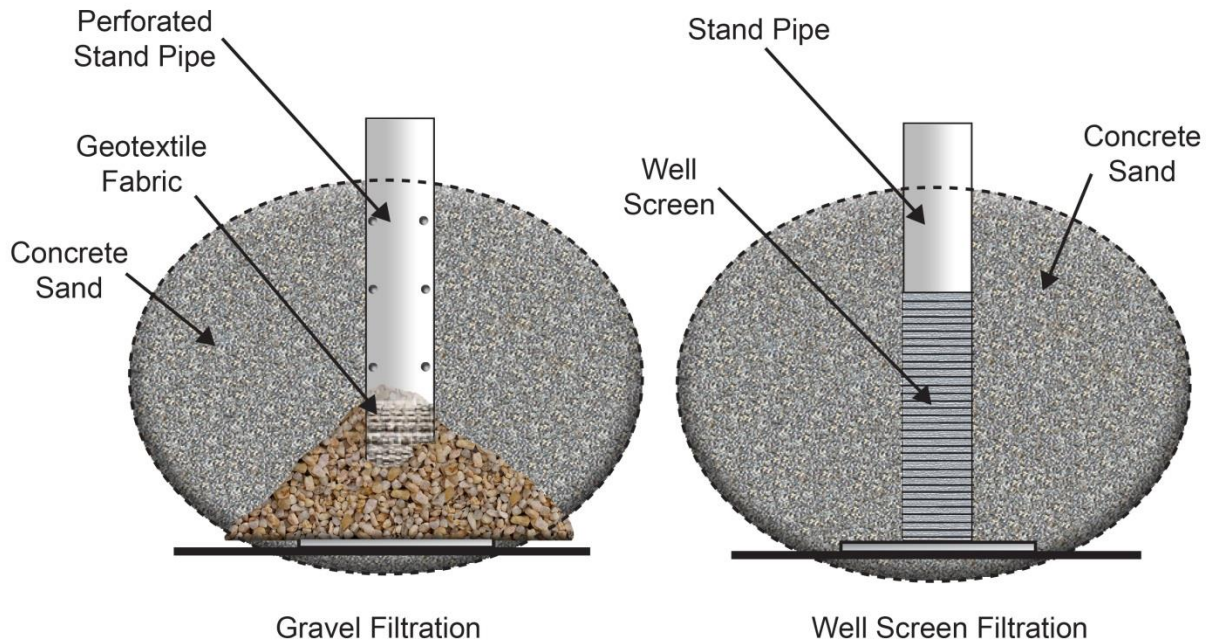

**Figure 4-12. Two examples of properly constructed standpipes.**

8. The finished bed should be planted with a combination of both shallow- and deep-rooting perennials. The species chosen, particularly the deep-rooted species, should be tolerant of elevated salinity levels. Small shrubs, large trees, and other woody deep-rooted plants are prohibited. Plants should be planted before system use and according to an acceptable planting schedule that will minimize plant die-off due to lack of water, excessive heat or cold, or other detrimental conditions.
9. The ET or ETI system should be fenced or placed in a location that prevents small children or pets from accessing its surface.

#### 4.6.6 Leak Testing

1. The ET system's liner must be leak-tested after the bed is filled with concrete sand. This test is required to verify that the integrity of the ET system's synthetic liner has not been compromised during construction. Additionally, in an ET system, this test will verify that the synthetic liner seams have been assembled properly. The liner must pass the leak test to successfully pass the final inspection and receive authorization to be put into use by the health district.
2. The leak test consists of filling the ET system with water to the inlet invert. Water may be any available water that is not classified as wastewater as specified by IDAPA 58.01.03.003.36. Allow the water to stand in the ET system for at least 5 days. This will allow time for any trapped air to be absorbed into the water. Refill the system to the inlet invert after the resting period if necessary.
3. Measure and record the elevation observed in a standpipe from an identified datum. An acceptable datum may be a predetermined point on the top edge of the standpipe. Clearly mark the selected datum for future reference and use.
4. Allow the system to lie undisturbed for at least 48 hours.
5. Return after the 48-hour dormancy period and measure the water elevation from the datum.
6. Passing criteria for an ET system is as follows:  
Water elevation in an ET system shall not drop by more than 1/8 inch in a 24-hour period.
7. Pump out the water via the standpipe(s) at the end of the leak test.

#### 4.6.7 Operations and Maintenance Requirements

1. Fertilizing the system is not required.
2. System irrigation is not required but may be allowed during prolonged droughts or periods of excessive heat to maintain a healthy plant population. At no time should irrigation become a significant contributor to the liquid in the system. This will hydraulically overload the system resulting in surfacing effluent.
3. Monthly monitoring and recording of the system's effluent depth is required for the first year. In subsequent years, effluent depth can be monitored and recorded quarterly. Measured effluent depths shall be submitted to the appropriate health district annually. Unexpectedly low or high effluent depths shall be immediately reported to the health district. The health district shall assist the owner in finding the appropriate corrective action. This reporting is required because of the following:
  - a. The lack of expected effluent may indicate a leaking system.
  - b. Excessive effluent, indicated by an active high-water alarm, may indicate excessive water usage, leaking toilet, or excessive irrigation of the system.
4. Periodic surface maintenance may be required for any of the following reasons:
  - a. In the summer, if the surface contains grasses, they should be mowed periodically, and the clippings removed and disposed of with other yard refuse.
  - b. Autumn maintenance may include gently spreading leaves over the surface, and allowing the resident flora to die back. Refuse removal is not necessary. A thin layer

- of leaves will provide a thermal blanket that will keep the system from freezing during the winter.
- c. No maintenance is foreseen for winter operation.
  - d. Spring maintenance may require removing refuse cover to allow the new growth to access light.
5. A pool test kit may be used to monitor effluent salinity. It is recommended that salinity tests be conducted at the end of the summer or in early autumn. Record the value along with the effluent depth. Plants showing signs of stress may indicate excess salinity in the system.
  6. Periodic system pumping and flushing may be required to prevent salinity build up. Excessive salinity will inhibit plant growth and could reduce evaporation from the system. The system should be pumped concurrently with the septic tank maintenance every 3–7 years. Backflushing with clean water may be necessary to dissolve residual salts. A second pumping of the system could further reduce the system’s salinity.

#### 4.6.8 Additional System Considerations

1. Ion exchange water softeners, those that use salt (sodium or potassium chlorides), are not recommended for discharge to ET or ETI systems due to excessively quick salt buildup. If an ion exchange water softener is used in the home, system pumping and flushing may be required multiple times a year to prevent stressing the plants and building up an impermeable salt layer inside the system.
2. Unless the net evaporation (the difference between total precipitation and evaporation) is large, the size required for ET systems may be impractical. In Kuna, Idaho, where the net evaporation is 25 inches per year, a system for a three-bedroom home may exceed 10,000 square feet and have either a diameter exceeding 120 feet, or be a square of about 105 feet on each side.
3. No substantiating evidence is currently available to support reduction in area required for ET or ETI designs below that which is provided herein.
4. Sources for identifying and obtaining plants recommended for populating the ET system surface may include, but not be limited to:
  - a. Natural Resources Conservation Service
  - b. University of Idaho Extension
  - c. Rocky Mountain Native Plant Company, 3780 Silt Mesa Road, Rifle, CO 81650

#### 4.6.9 Evapotranspiration System Calculation Example

The sections below discuss each column found in Table 4-6, water mass balance for an ET or ETI system (section 4.6.3). Use Table 4-6 for calculating water mass balance (section 4.6.3). Start with the first month in which storage will be positive; in Idaho, that is usually October. Calculations for each column in Table 4-6 are provided in the following sections.

**Calculations for the Precipitation Rate (Column A)**

1. Go to the Desert Research Institute, Idaho Climate Summaries website at: <http://www.wrcc.dri.edu/summary/climsmid.html>.

Select one of the 152 statewide sites located nearest the proposed system’s site. The first web page for the location is the Period of Record Monthly Climate Summary. Record the 12-monthly average total precipitation values and the annual average precipitation value from this page. As shown in Equation 4-7, divide each month’s average precipitation by the annual average and record the resulting value as the Monthly Precipitation Contribution (MPC).

$$MPC_{Jan} = \text{Monthly\_Average}_{Jan} / \sum_{X=Jan}^{Dec} \text{Monthly\_Average}_X \quad \text{Equation 4-7. Monthly precipitation contribution (Table 4-6, column A).}$$

$$MPC_X = \dots$$

$$MPC_{Dec} = \text{Monthly\_Average}_{Dec} / \sum_{X=Jan}^{Dec} \text{Monthly\_Average}_X$$

2. In the left column of this web page, scroll down the left side and click Monthly Totals, under the subheadings Precipitation and Monthly Precipitation Listings. This will provide the Monthly Total Precipitation table (in inches) for the selected site’s period of record. Evaluate the provided monthly average data, omitting any annual total if any 1 month shows more than 3 days of data missing. Identify the remaining years of acceptable data, count the total number of valid points (number of acceptable annual average values) and then go to the website at <http://onlinecalc.sdsu.edu/onlinepearson2.php>, which provides assistance with calculating flood frequency by the Log Pearson III method 2 (online Log Pearson III calculator provided by San Diego State University). To use the calculator, follow these steps:
  - a. Select “US Customary” units.
  - b. Indicate the number of years of average annual precipitation data.
  - c. Enter the data, using commas and no spaces to separate values, in the window that requests “Enter flood series Q.” The number of annual data values provided must equal the number of years entered in step b.
  - d. Click the Calculate button. The results will appear in a new window. The input data will appear first, followed by the results. Find and record the Q<sub>10-yr</sub> value.
3. Multiply the Q<sub>10-yr</sub> value by each month’s MPC, calculated in step 1 above. Record each of these values in Table 4-6, column A, in the corresponding month’s row.

**Calculations for Effluent Depth (Column B)**

For monthly accumulation of wastewater,

1. Obtain the average daily wastewater flow for the home as specified in IDAPA 58.01.03.007.08; i.e., X = 3 bedroom home = 250 GPD. Add or subtract 50 GPD for each bedroom according to IDAPA 58.01.03.007.08.

2. Multiply
  - a. The home's average daily wastewater flow (X GPD) by the number of days in the month under consideration, yielding gallons per month.
  - b. Convert each month's result to cubic feet per month (ft<sup>3</sup>/month) by multiplying by 0.1337 ft<sup>3</sup>/gallon.
  - c. Multiply the cubic feet per month value by the chosen peaking factor (PF) [1.0 ≤ PF ≤ 1.6].
  - d. Divide this product by the initial estimated ET or ETI system area (T<sub>ETarea</sub> or T<sub>ETIarea</sub>) as calculated in Equation 4-1.
3. Record the resulting effluent depth for the month under consideration in Table 4-6, column B.

### **Calculations for Evapotranspiration (Column C)**

Evapotranspiration values can be obtained from either the AgriMet Agricultural Weather Network website, at <http://www.usbr.gov/pn/agrimet/monthlyet.html> or from the University of Idaho Kimberly Research and Extension Center website at <http://www.kimberly.uidaho.edu/ETIdaho/>.

1. If you choose to use data from AgriMet follow the directions below, otherwise skip to step 2:
  - a. Because the values supplied are in inches per month, divide each month's value by 12 inches per foot to obtain feet per month.
  - b. Use only the data for March–October and multiply each monthly value by the 0.7 adjustment factor to account for vegetation different from alfalfa. Alfalfa is the crop used to develop the AgriMet data.
  - c. Record the result for each month in that month's row in Table 4-6, column C.
2. If you choose to use data from the Kimberly Research and Extension Center, follow these steps:
  - a. Access the datasets at <http://www.kimberly.uidaho.edu/ETIdaho/>. Select a weather station and click "Submit Query."
  - b. Select a crop, typically either
    - 1) Grass–Turf (lawns)–irrigated, or
    - 2) Pasture Grass–high maintenance
  - c. Select the potential daily ET<sub>c</sub> (ET<sub>pot</sub>).
  - d. Use the Monthly Mean values. The values supplied are in millimeters per day (mm/day).
    - 1) Multiply each value by the number of days in that month, to obtain millimeters per month (mm/month).
    - 2) Divide the millimeters per month value by 25.4 millimeters per inch (mm/in.), to obtain inches per month.
    - 3) Divide the inches per month value by 12 inches per foot, to obtain feet per month.
  - e. Record the result for each month in that month's row in Table 4-6, column C.

**Calculations for Infiltration (Column D)**

Calculate the allowed monthly infiltration by multiplying the daily wastewater generation rate by the number of days in the month and multiplying again by 0.10. Record each value in the corresponding month in Table 4-6, column D.

**Calculations for Change in Storage (Column E)**

Calculate the change in storage ( $\Delta$  storage) for each month. This will require that you add the precipitation, column A, to the effluent generated in the house, column B. Finally, subtract the evapotranspiration, column C, and infiltration, if present, column D. Record the result for each month in Table 4-6, column E.

**Calculations for Cumulative Storage (Column F)**

1. To complete column F, start by copying the value for October from Table 4-6, column E into column F.
2. Add the column E value for the next month to the previous month’s value in column F. Record this value in column F.
3. Repeat the previous step for all 12 months.

Equation 4-8 gives the calculation for cumulative storage.

$$F_{Oct} = E_{Oct}$$

$$F_{Nov} = F_{Oct} + E_{Nov}$$

$$F_{Dec} = \dots$$

$$F_{Sept} = F_{Aug} + E_{Sept}$$

**Equation 4-8. Cumulative storage (Table 4-6, column E).**

**Calculations for Saturated Bed Depth (Column G)**

1. As shown in Equation 4-9 divide each month’s cumulative storage value in Table 4-6, column F by the porosity of the bulk material that the system is made of. Typically, the concrete sand has a porosity of 35% (0.35). If the monthly value in column F is less than zero, put zero in column G.

$$G_{Oct} = F_{Oct} / 0.35$$

**Equation 4-9. Saturated bed depth (Table 4-6, column F).**

2. Identify the largest value in column G. This should occur in the spring, just before the growing season starts. The value must be less than 2.5 feet to accommodate the 1.5 feet of overburden topsoil and not exceed a maximum system depth of 4 feet.
3. If the maximum depth is greater than 2.5 feet, increase the system’s surface area and recalculate.
4. If the maximum depth is less than 2.5 feet, decrease the system’s surface area and recalculate.



5. Repeat this process until a surface area is identified that yields a saturated bed depth of 2.5 feet for the site’s specific precipitation and evaporation characteristics when coupled with the future home’s proposed wastewater generation rate.
6. If a suitably sized ET or ETI system is not determined, then
  - a. Vary the PF but do not go below a PF of one ( $PF \geq 1$ ).
  - b. Vary the number of bedrooms in the home.

Table 4-7 shows sample calculations for a three-bedroom home discharging 250 GPD in the Caldwell, Idaho, area into an ET system.

**Table 4-7. Sample water mass balance calculations for an ET system.**

Month	A	B	C	D	E	F
	Precipitation Rate (feet)	Effluent Depth (feet)	Evapo-transpiration (feet)	Change ( $\Delta$ ) in Storage (feet)	Cumulative Storage (feet)	Saturated Bed Depth (feet)
Oct.	0.086	0.087	0.232	-0.059	-0.059	0
Nov.	0.135	0.086	0.000	0.221	0.162	0.46
Dec.	0.142	0.089	0.000	0.231	0.393	1.12
Jan.	0.152	0.089	0.000	0.241	0.634	1.81
Feb.	0.118	0.080	0.000	0.198	0.832	2.38
March	0.122	0.089	0.167	0.044	0.876	2.50
April	0.108	0.086	0.327	-0.133	0.743	2.12
May	0.111	0.089	0.449	-0.249	0.494	1.41
June	0.088	0.086	0.544	-0.370	0.124	0.35
July	0.030	0.089	0.609	-0.490	-0.366	0
Aug.	0.031	0.089	0.497	-0.377	-0.743	0
Sept.	0.058	0.086	0.368	-0.224	-0.967	0

Since this system eliminates all discharged wastewater before year-end, and a maximum saturated bed depth of 2.5 feet appears in March, the system’s size is acceptable. The lack of a saturated layer during the heat of summer indicates that supplemental irrigation (sprinkler) will be required to maintain healthy plants.

Table 4-8 shows sample calculations for a three-bedroom home discharging 250 GPD in the Caldwell, Idaho, area into an ETI system.

**Table 4-8. Sample water mass balance calculation for ETI system.**

	A	B	C	D	E	F	G
Month	Precipitation Rate (feet)	Effluent Depth (feet)	Evapo-transpiration (feet)	Infiltration (feet)	Change ( $\Delta$ ) in Storage (feet)	Cumulative Storage (feet)	Saturated Bed Depth (feet)
Oct.	0.086	0.165	0.237	0.0088	0.0056	0.0056	0.006
Nov.	0.135	0.160	0.041	0.0085	0.2460	0.2520	0.719
Dec.	0.141	0.165	0.014	0.0088	0.2830	0.5350	1.530
Jan.	0.152	0.165	0.016	0.0088	0.2920	0.8270	2.360
Feb.	0.119	0.149	0.033	0.0080	0.2260	1.0530	3.000
March	0.121	0.165	0.110	0.0088	0.1670	1.2200	3.480
April	0.108	0.160	0.306	0.0085	-0.0470	1.1700	3.350
May	0.111	0.165	0.440	0.0088	-0.1730	1.0000	2.860
June	0.088	0.160	0.485	0.0085	-0.2460	0.7540	2.150
July	0.030	0.165	0.52	0.0088	-0.3338	0.4202	1.200
Aug.	0.032	0.165	0.461	0.0088	-0.2730	0.1472	0.421
Sept.	0.058	0.160	0.353	0.0085	-0.1430	0.0042	0.012

Since there is an excess remaining at the end of the year, this system’s area will have to be increased and the calculations repeated. This process is continued until an area is identified that yields no excess effluent in the system at the end of the year.

## 4.7 Experimental System

Revision: June 5, 2014

Installer registration permit: Complex

Licensed professional engineer required: Yes

### 4.7.1 Description

An experimental system includes an individual or subsurface sewage disposal system or component that has not been previously used in Idaho or one that requires field review before approval as an alternative system or subsurface sewage disposal system component.

### 4.7.2 Approval Conditions

1. If produced by a manufacturer, the experimental system should remain in the ownership of that manufacturer until approval of the system component has been provided as described by IDAPA 58.01.03.009 or section 1.4 of this manual.
2. All information required by IDAPA 58.01.03.009.02–03 regarding the system or component shall be provided to DEQ prior to subsurface sewage disposal permit issuance.
3. The manufacturer and property owner must hold DEQ and the health district harmless from any liability arising from use of the system.
4. A variance must be approved by DEQ as described in IDAPA 58.01.03.010 prior to permit issuance by the health district for the experimental system. The petition for variance should be submitted to DEQ's on-site wastewater coordinator. The subsurface sewage disposal permit application must be submitted to the health district where the experimental system is intended to be installed prior to submitting the petition for variance to DEQ.
5. The site for system or component installation must otherwise be acceptable for a standard system or approved alternative system.
6. The property owner must agree to replace the experimental system with a standard system or approved alternative system that meets the requirements of IDAPA 58.01.03 should DEQ or the health district determine that the system is a failing system (IDAPA 58.01.03.004.05).
7. Conditions for use of the system should be contained in the permit, including, if necessary, operation and maintenance requirements and conditions for abandonment (IDAPA 58.01.03.005.13 and 58.01.03.005.14).
8. It is recommended that the property owner or manufacturer secure a performance bond in the amount of the replacement system.

### 4.7.3 Design Requirements

1. The design of the system shall be provided by a PE licensed in Idaho, unless the design is a premanufactured and packaged system or component.
2. All components in contact with wastewater, effluent, or treated wastewater must be compatible with those waters. Such products should not decompose, dissolve, or otherwise contaminate processed waters at the point of discharge from the unit.

3. All components subject to wear or maintenance must be easily accessible and replaceable.

#### **4.7.4 Construction**

1. Installation instructions provided by the manufacturer should be used when installing the system.
2. Licensed public works contractors, plumbers, or electricians may be required to install respective components of experimental systems.

#### **4.7.5 Operation and Maintenance**

1. An O&M manual shall be provided by the system or component's design engineer or manufacturer to DEQ and the health district prior to permit issuance.
2. All operation and maintenance specified by the design engineer or manufacturer and DEQ or the health district shall be contained in the O&M manual and provided as part of the permit application (IDAPA 58.01.03.005.14).

## 4.8 Extended Treatment Package System

Revision: May 6, 2020

Installer registration permit: Complex

Licensed professional engineer required: No

### 4.8.1 Description

Manufactured and *packaged* mechanical treatment devices that provide additional biological treatment to septic tank effluent. Such units may use extended aeration, contact stabilization, rotating biological contact, trickling filters, or other approved methods to achieve enhanced treatment after primary clarification occurs in an appropriately sized septic tank. These systems provide secondary wastewater treatment capable of yielding high-quality effluent suitable for discharge in environmentally sensitive areas.

Property owners that install an ETPS unit must choose a service provider capable of meeting their OMM requirements. Verification of the chosen service provider shall be submitted with the subsurface sewage disposal permit application ensuring that the OMM (effluent quality testing) will occur (IDAPA 58.01.03.005.04.k). Property owners that do not want to meet the OMM requirements must meet the requirements of section 4.8.2(2) or choose another alternative system that will meet the conditions required for subsurface sewage disposal permit issuance.

### 4.8.2 Approval Conditions

1. A service provider will be available to provide managed system OMM as described in section 1.9.1 and 1.9.2 (IDAPA 58.01.03.005.14). The OMM is to be performed by an approved service provider (IDAPA 58.01.03.006.06). Approval of the service provider will be made by the Director before permit issuance. Approvable entities may include, but are not limited to, the following:
  - a. Municipal wastewater treatment departments
  - b. Water or sewer districts
  - c. Licensed complex installer with a service provider certificationA service provider contract should be entered into between the property owner and the service provider, as a necessary condition for issuing an installation permit (IDAPA 58.01.03.005.04.k).
2. ETPSs may be used for properties without an approved service provider **only under all of the following conditions**:
  - a. The site is acceptable for a standard system. All separation distances from ground water, surface water, and limiting layers shall be met.
  - b. Enough land is available, and suitable, for two full-size drainfields. One complete full-size drainfield shall be installed.
3. Final effluent disposal through subsurface discharge will meet the following criteria:
  - a. Manufacturers seeking approval on ETPS units for reducing total suspended solids (TSS) and carbonaceous biological oxygen demand (CBOD5) must submit NSF/ANSI Standard 40 approvals, reports, and associated data or equivalent third-

party standards. Manufacturers also seeking approval on the ETPS units for reduction of total nitrogen (TN) must submit NSF Standard 245 approvals, reports, and associated data or equivalent third-party standards.

- 1) Otherwise, the effluent must be discharged to a standard drainfield, sized as directed in IDAPA 58.01.03.008 (section 7.1), and meet the required effective soil depth for standard drainfields as directed in IDAPA 58.01.03.008.02.
  - 2) Additional drainfield-sizing reduction granted for use of gravelless trench products is not allowed.
- b. TN reduction may be required for ETPS units located in an area of concern as determined through an NP evaluation. Permit-specific TN reduction levels will be determined through the NP evaluation. Results for TN are determined through the addition of TKN and nitrate-nitrite nitrogen ( $TN = TKN + [NO_3 + NO_2 - N]$ ). TN reduction will be accepted as being met if the effluent exhibits a quantitative value obtained from laboratory analysis not to exceed the TN level stipulated on the subsurface sewage disposal permit.
4. Annual effluent monitoring for CBOD<sub>5</sub>, TSS, and TN (if seeking approval for TN reduction) is required for ETPS models listed under provisional use (Table 5-3), or as specified in permit conditions. Annual effluent monitoring of TN is only required for ETPS models listed under general use (Table 5-4) that treat TN to less than 27 mg/L. All ETPS models are subject to meet the applicable monitoring requirements in section 1.9.2 and reporting requirements of section 1.9.3.
  5. The ETPS will be preceded by an appropriately sized septic tank.
    - a. The septic tank may be either a separate septic tank, a volume integral with the system's package, or a combination of internal clarifier volume coupled with an external tank.
    - b. The septic tank shall provide the minimum tank capacity for residential facilities as specified in IDAPA 58.01.03.007.07.a, or for nonresidential facilities, a minimum of 2 days of hydraulic residence time (HRT) as stipulated in IDAPA 58.01.03.007.07.b.
    - c. Timed dosing from the clarifier to the aerobic treatment unit is preferred and highly recommended to maintain a constant source of nutrients for the system's aerobic microbes.

### 4.8.3 ETPS Unit Design

Procedures relating to design are required by IDAPA 53.01.03 (section 7.1) or may be required as permit conditions, as appropriate, to ensure protection of public health and the environment.

1. All materials will be durable, corrosion resistant, and designed for the intended use.
2. All electrical connections completed on site shall comply with the National Fire Protection Association (NFPA) Standard NFPA 70, National Electrical Code, as required by the Idaho Division of Building Safety, Electrical Division.
3. Design for each specific application should be provided by a PE licensed in Idaho.
4. Manufactured and *packaged* mechanical treatment devices will be required to prove that the specified equipment model meets the ETPS product approval policy outlined in section 1.4.2.2.

#### 4.8.4 Construction

Procedures relating to construction are required by IDAPA 58.01.03 (section 7.1) or may be required as permit conditions, as appropriate, to ensure the protection of public health and the environment.

##### 1. Installation

- a. A licensed complex system installer shall be required to install an ETPS unit and all other portions of the septic system connected to the ETPS unit or that the ETPS unit discharges to (IDAPA 58.01.03.006.01.b).
- b. A public works contractor may install an ETPS unit if they are under the direct supervision of a PE licensed in Idaho.
- c. Licensed plumbers and electricians will be required to install specific devices and components for proper system operation. If the device requires any on-site fabrication or component assembly, a public works contractor should be used.
- d. A sample port will be installed in the effluent line after the aerobic treatment unit. Figure 4-13 shows the placement of a sampling port after the ETPS unit, and Figure 4-14 shows the sample port and drainfield after the septic and treatment tank.

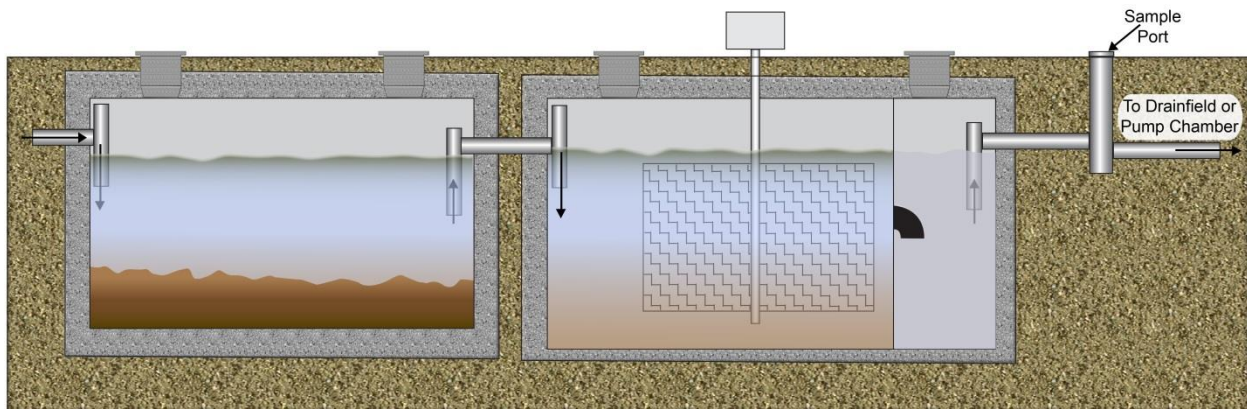
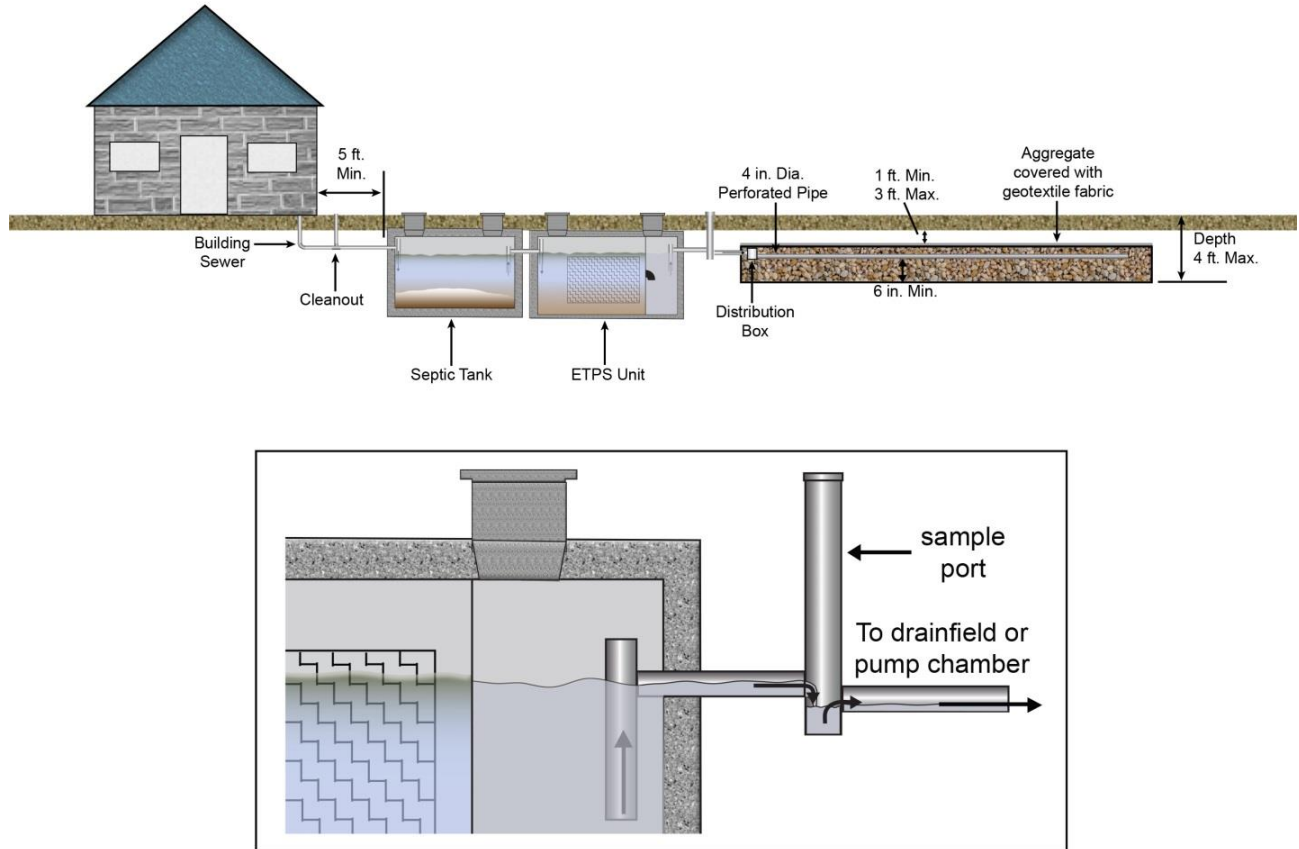

Figure 4-13. Sampling port example.



**Figure 4-14. Sampling port and drainfield.**

2. Within 30 days of completing the installation, the property owner shall provide certification to the regulatory authority, from their manufacturer's representative, that the system has been installed and is operating in accordance with the manufacturer's recommendations (IDAPA 58.01.03.005.15).
  - a. A statement requiring the submission of the installation verification form described above shall be written on the face of the subsurface sewage disposal permit.
  - b. The regulatory authority shall not finalize the subsurface sewage disposal permit until the certification of proper installation and operation is received and includes information on the manufacturer, product, model number, and serial number of the ETPS unit installed.



## 4.9 Extra Drainrock Trench

Revision: December 10, 2014

Installer registration permit: Property owner or standard and basic

Licensed professional engineer required: No

### 4.9.1 Description

An extra drainrock trench is an aggregate-filled trench (1 to 6 feet wide) with more than 6 inches of aggregate under the perforated pipe. Figure 4-15 shows a typical cross section of a standard trench using extra drainrock. Figure 4-16 shows a typical cross section of an above-grade capping fill trench using extra drainrock. When more than 6 inches of aggregate is installed under the perforated pipe in a drainfield, the required drainfield length may be reduced. This section explains the conditions and calculations involved.

### 4.9.2 Approval Conditions

1. The site must meet the requirements for site suitability (IDAPA 58.01.03.008.02, section 7.1) except that
  - a. The site may have a slope between 21% and 46% if the system is constructed according to the steep slope system requirements (section 4.26), and more than 12 inches of aggregate is installed under the perforated pipe in the drainfield, 12 inches of which is not used in determining the multiplication factor.
  - b. The site slope may not exceed 20% if the top of the drainfield is less than 24 inches below the ground surface and 12% if the drainfield aggregate extends above the ground surface. The drainfield must be constructed according to the capping fill system requirements (section 4.3) except that the drainfield may not exceed 6 feet in width.
2. The bottom of the drainfield may be no deeper than 48 inches below the ground surface.
3. Multiplying factors cannot be used in addition to alternative soil application rates allowed by ETPSs, recirculating gravel filters, or intermittent sand filters.
4. Extra drainrock trenches may not be used to reduce trench length in sand mounds.
5. Multiplication factors less than 0.50 are not allowed.
6. Gravelless drainfield components may not be substituted for aggregate.

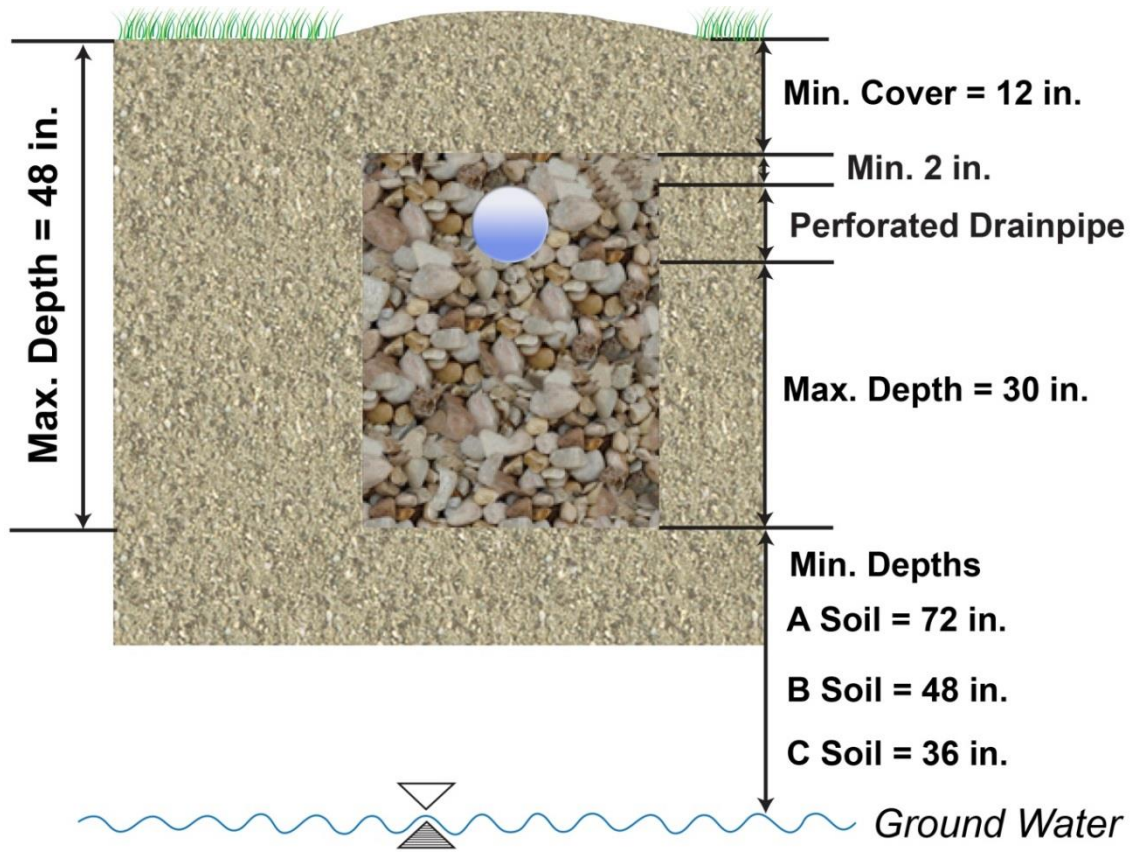

Figure 4-15. Cross section of standard trench with extra drainrock.

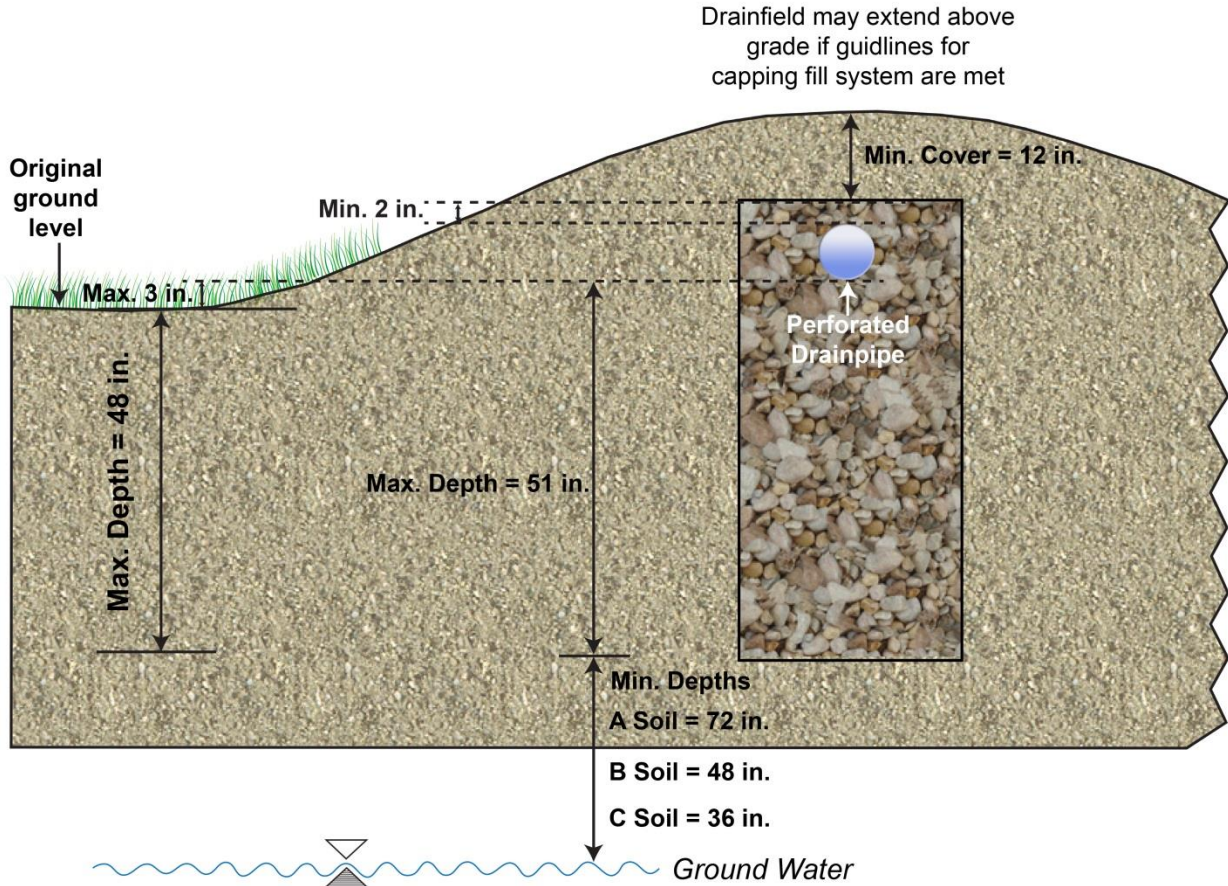

Figure 4-16. Cross section of an above-grade capping fill trench with extra drainrock.

### 4.9.3 Calculations

To determine required drainfield length when extra drainrock is installed, use the appropriate multiplication factor to adjust the standard trench length. Standard length is indicated in Table 3-2 (section 3.2.4).

The appropriate multiplication factor depends on the trench width and depth of gravel below the perforated pipe in the drainfield. Determine the appropriate multiplication factor as follows:

- Locate the factor in Table 4-9 for the particular combination of trench width and gravel depth below the drainpipe, or
- If the particular combination of trench width and gravel depth is not given in Table 4-9, use Equation 4-10.

**Table 4-9. Multiplication factors to adjust drainfield length for extra drainrock.**

Gravel Depth Below Perforated Pipe (inches)	Trench Width (inches)							
	12	18	24	30	36	48	60	72
12	0.75	0.78	0.80	0.82	0.83	0.86	0.87	0.89
18	0.60	0.64	0.66	0.69	0.71	0.75	0.78	0.80
24	0.50	0.54	0.57	0.60	0.62	0.66	0.70	0.73
30	a	a	0.50	0.53	0.55	0.60	0.64	0.67
36	a	a	a	a	0.50	0.54	0.58	0.61
42	a	a	a	a	a	0.50	0.54	0.57
48	a	a	a	a	a	a	0.50	0.53

a. Multiplication factor is less than 0.50; use 0.50 if this depth and width are desired.

$$\text{Multiplying Factor} = \frac{\text{Trench Width} + 2}{\text{Trench Width} + 1 + (2 \times \text{Gravel Depth})} = \frac{W + 2}{W + 1 + (2 \times D)}$$

**Equation 4-10. Multiplication factor.**

where:

W = trench width in feet  
D = gravel depth in feet

**Example 1:**

$$\text{Multiplying Factor} = \frac{W + 2}{W + 1 + (2 \times D)} = \frac{3 + 2}{3 + 1 + 2(1)} = \frac{5}{6} = 0.83$$

where:

Trench width (W) = 36 inches or 3 feet.  
Gravel depth (D) = 12 inches or 1 foot.

**Example 2:**

$$\text{Multiplying Factor} = \frac{W + 2}{W + 1 + (2 \times D)} = \frac{6 + 2}{6 + 1 + 2(3.5)} = \frac{8}{14} = 0.57$$

where:

Trench width (W) = 72 inches or 6 feet.  
Gravel depth (D) = 42 inches or 3.5 feet.

**Example 3:**

A three-bedroom home is proposed to be located on a site with uniform silt loam soil (soil design subgroup B-2; section 2.1.2, Table 2-4) and normal high ground water at 7 feet. In section 2.2.2, Table 2-5 shows the minimum distance from trench bottom to normal high ground water as 3 feet for this soil design subgroup. Maximum depth of the trench is 4 feet. The total absorption area required for the home is 556 ft<sup>2</sup> ([250 gallons/dwelling]/[0.45 GPD/ft<sup>2</sup>/day]), equivalent to trench dimensions of 3 feet wide and 185.5 feet in length (no trench may exceed 100 feet in total length for gravity distribution). With 30 inches of aggregate under the perforated pipe in the drainfield and a trench width of 36 inches, the trench length would be reduced to 55% of the 185.5-foot standard length (0.55 = 55%) or 102 feet, according to the appropriate multiplication factor (Table 4-9). This was calculated as follows:

1. Calculate the drainfield area required for a three-bedroom home.

$$\text{Trench Bottom} = \frac{\text{daily flow}}{\text{application rate}} = \frac{250 \text{ GPD}}{0.45 \text{ GPD/square foot}} = 556 \text{ square feet}$$

2. Calculate the length of trench required for the drainfield.

$$\text{Trench Length} = \frac{\text{trench bottom}}{\text{trench width}} = \frac{556 \text{ square feet}}{3 \text{ feet}} = 185.5 \text{ foot trench}$$

3. Using the appropriate factor from Table 4-9, calculate the reduced trench length for a drainfield 185.5 feet long, 36 inches wide with 30 inches of gravel under the drain pipe

Trench Reduction = (Trench length)(Multiplying Factor) = (185.5 foot trench)(0.55) = 102-foot total trench length. Two trenches will need to be constructed that in total provide 102 feet in trench length.

**Example 4:**

A three-bedroom home is proposed to be located on a site with uniform clay loam soil (soil design subgroup C-2; section 2.1.2, Table 2-4), normal high ground water at 5 feet, and a slope less than 6%. In section 2.2.2, Table 2-5 shows the minimum distance from trench bottom to normal high ground water as 2.5 feet for this soil design subgroup. Maximum depth of the trench is 2.5 feet. The total absorption area required for the home is 1,250 ft<sup>2</sup> ([250 gallons/dwelling]/[0.2 GPD/ft<sup>2</sup>/day]), equivalent to trench dimensions of 6 feet wide and 209 feet in length (no trench may exceed 100 feet in total length for gravity distribution). To maximize the multiplication factor, the system is chosen to be constructed as an extreme capping fill-extra drainrock trench. This allows 33 inches of aggregate under the perforated pipe in the drainfield. With a trench width of 72 inches, the trench length would be reduced to 64% of the 209-foot standard length (0.64 = 64%) or 134 feet, according to the appropriate multiplication factor (Equation 4-10). This was calculated as follows:

1. Calculate the drainfield area required for a three-bedroom home.

$$\text{Trench Bottom} = \frac{\text{daily flow}}{\text{application rate}} = \frac{250 \text{ GPD}}{0.2 \text{ GPD/square foot}} = 1,250 \text{ square feet}$$

2. Calculate the length of trench required for a standard drainfield.

$$\text{Trench Length} = \frac{\text{trench bottom}}{\text{trench width}} = \frac{1,250 \text{ square feet}}{6 \text{ feet}} = 209 \text{ foot trench}$$

3. Using the appropriate multiplication factor calculated through Equation 4-10, determine the reduced trench length for a drainfield 209 feet long, 72 inches wide, with 33 inches of gravel under the perforated drain pipe.

Trench Reduction = (Trench Length)(Multiplying Factor) = (209 foot trench)(0.64) = 134-foot total trench length. Two trenches will need to be constructed that in total provide 134 feet of trench length.

## 4.10 Floating Vault Toilets and Boat or Vessel Sewage Disposal

Revision: May 21, 2015

Installer registration permit: Property owner or standard and basic

Licensed professional engineer required: No

### 4.10.1 Description

#### 4.10.1.1 Floating Vault Toilet Description

Vault toilets and boat/vessel dump stations are necessary wastewater disposal facilities at recreational sites around water bodies. Many boats and vessels do not contain onboard toilets making it necessary to provide toilet facilities at recreation sites around water bodies such as boat ramps, docks, and campgrounds. The facilities provided most often are vault toilets. Due to the remoteness of some recreation sites, installation of a standard vault privy (section 4.29) may not be possible. Additionally, some recreational water bodies may be large enough that convenient use of a standard vault privy on shore is not feasible. To preserve the quality and beneficial uses of the waters of the state of Idaho it is preferable to have toilet facilities available at recreational areas that attract a large number of users. To accomplish this at recreational water sites, floating toilet facilities may be used for temporary storage of sewage.

#### 4.10.1.2 Boat or Vessel Sewage Disposal Description

Some boats and vessels do contain onboard toilet facilities that are classified as Type I, II, and III marine sanitation devices (MSD) or portable toilets. Type I and II MSD may have the ability to treat and discharge wastewater from the boat or vessel into the surrounding waters while a Type III MSD is certified to a no-discharge standard. Portable toilets are sewage collection devices that are self-contained and removable from a boat or vessel. Regardless of a boat or vessel's MSD type or use of portable toilets, discharge of wastewater or sewage (treated or untreated) from a boat or vessel into waters of the state of Idaho is illegal per IDAPA 58.01.02.080. The rule requires that any wastewater or sewage generated and stored on a boat or vessel must be disposed of at an approved facility (e.g., recreational vehicle dump station, septic system, or public system).

### 4.10.2 Approval Conditions

1. Wastewater generated on a boat or vessel and held in an MSD may be removed while the boat remains in the water by the following:
  - a. Dockside sewage connection to an approved municipal treatment system or an approved subsurface sewage disposal system sized for this use. Dockside sewage collection systems shall be reviewed and approved by DEQ.
  - b. Mobile boat pump-out service. Pump-out services constructed on a boat, vessel, or vehicle that is used to transport sewage or wastewater for disposal must be permitted by a health district (IDAPA 58.01.03.050). Small mobile pump stations that are nonmotorized and only used to pump boat holding tanks at a dock or marina and used to transport the contents to an approved disposal facility located near the dock or marina do not need to be permitted by a health district.

- c. Pump-out station that transfers wastewater from a boat or vessel to an approved municipal treatment system or an approved subsurface sewage disposal system sized for this use. Permanent pump-out stations constructed with a transport line from the pump-out location to the approved disposal site shall be reviewed and approved by DEQ as part of a sewage collection system.
2. Wastewater generated on a boat or vessel and held in an MSD that is not removed while the boat is in the water shall be disposed of in one of the following locations:
  - a. An approved municipal treatment system or an approved subsurface sewage disposal system
  - b. An approved RV dump station
3. Wastewater generated on a boat or vessel and held in a portable toilet may not be discharged overboard, on the ground or into surface waters, and shall be disposed of in one of the following locations:
  - a. An approved municipal treatment system or an approved subsurface sewage disposal system
  - b. An approved RV dump station
4. Floating vault toilet facilities located over waters of the state of Idaho shall be permitted by a health district and must meet the requirements of section 4.10.3.

#### **4.10.3 Floating Vault Toilet Design Requirements**

1. Floating vault toilets are limited to use on lakes, reservoirs, and ponds, where municipal services and subsurface sewage services are not available.
2. Floating vault toilets shall not be located within 300 feet of a surface water intake used for a drinking water supply.
3. Floating vault toilets must be pumped by an Idaho-permitted septic tank pumper. The pumper must be identified in the permit application and demonstrate they have the equipment necessary to access and pump the vault.
4. Floating vault toilets shall not be used as dump stations or holding tanks for wastewater generated in a boat or vessel's MSD or portable toilet.
5. The floating vault toilet shall be designed by a PE to ensure the structure is capable of withstanding adverse weather and wave action without tipping over, sinking, or sustaining severe damage, or may be obtained from a manufacturer with a design and model that has been preapproved by DEQ.
6. The floating vault tank, deck, and building shall meet the design requirements described in the following sections.

##### **4.10.3.1 Hull or Dock**

1. A floating vault toilet may be placed on an individual hull or dock that is either connected to shore or in the middle of the water body.
2. Hulls and docks shall be independently constructed from the vault tank and meet the following:
  - a. Capable of supporting the vault toilet when full



- b. Capable of withstanding adverse weather and wave action without tipping over, sinking, or sustaining severe damage
  - c. Securely anchored at their proposed location
3. Hulls or floating docks must be able to withstand towing or pushing to and from shore for storage and maintenance needs.

#### **4.10.3.2 Tank**

1. The vault tank shall be constructed to be watertight, constructed of durable materials that are not subject to excessive corrosion, decay, or cracking.
2. The vault tank shall be contained within an external shell (double-hulled) that is designed to protect the tank from impact and grounding and provides secondary containment if the vault tank develops a leak.
3. The vault tank shall be fitted with at least one clean-out hatch meeting the following minimum design requirements:
  - a. Closes to be watertight.
  - b. Locks so that the vault tank is not accessible to users.
4. The vault tank shall have a minimum capacity of 375 gallons for each toilet, except that no tank may be less than 500 gallons.
5. The vault tank shall be adequately vented and the vent shall be screened with a maximum screen size of 16-mesh.

#### **4.10.3.3 Building**

1. The building shall be firmly anchored to the hull or dock and rigidly constructed of materials that are capable of withstanding constant exposure to water.
2. All openings, spaces, and cracks that would permit flies to access the vault tank must be no wider than 1/16 inch.
  - a. Includes doors and seats when closed.
  - b. All gaps larger than 1/16 inch shall be screened with a maximum screen size of 16-mesh.
3. Doors shall be self-closing.
4. The building shall be adequately ventilated.
5. The seat opening shall be at least 12 inches from the side walls in all privies and spaced so that there is at least 24 inches between seats in multiple-seat installations.
6. The seat top shall not be less than 12 inches nor more than 20 inches above the floor.
7. The seat shall be constructed of nonabsorbent material.
8. The building shall contain an adequate number of grab bars inside and outside of the building.

#### **4.10.4 Operation and Maintenance**

The floating vault toilet permit application shall be accompanied with an operation and maintenance manual provided by the design engineer or manufacturer that includes the following information:

1. Operation, maintenance, and replacement instructions for any mechanical or electrical components
2. Pumping and servicing/cleaning instructions including pumping frequency
3. Seasonal maintenance needs
4. Annual or biannual maintenance needs
5. Launching, trailering, and anchoring instructions
6. On-water transportation instructions
7. Winterization needs

## 4.11 Gravelless Trench System

Revision: January 30, 2013

Installer registration permit: Property owner or standard and basic

Licensed professional engineer required: No

### 4.11.1 Description

A gravelless trench system meets all the requirements of a standard trench system except that the drainrock is replaced by an approved gravelless trench component (section 5.6). Typical components include gravelless chambers, large diameter nylon fabric wrapped piping of varying dimensions, and drainrock substitution systems. Approved gravelless products are granted a reduction in disposal area square footage. Reduction is only allowed in trench designs up to 36 inches in width. No reduction is allowed for installation widths greater than 36 inches, or for installation in sand mound designs.

### 4.11.2 Approval Conditions

1. Unless otherwise noted, the system must be installed according to the gravelless trench component manufacturer's recommendations.
2. Reduction in square footage cannot be in addition to other allowable disposal area reductions (i.e., drainfield reductions due to increased application rates for treatment).
3. The measured width of the installed product should be at least 90% of the excavated trench width (section 5.6, Table 5-10).

### 4.11.3 Design Requirements

1. Length of gravelless trench product needed should be calculated on the following basis:
  - a. Disposal trench length is determined by the application rating for each product (section 5.6, Table 5-9, rating column)

Example (large diameter pipe):

- 1) Product selected has a rating (square feet of application area per linear foot) of 1.33 ft<sup>2</sup>/ft
- 2) 3-bedroom home (250 GPD) in soil design subgroup B-1 soils (application rate of 0.6 GPD/square foot [ft<sup>2</sup>])
- 3)  $([250 \text{ GPD}]/[0.6 \text{ GPD}/\text{ft}^2])/(1.33 \text{ ft}^2/\text{ft}) = 314$  linear feet of gravelless trench product

Example (gravelless chamber):

- 1) Product selected has a rating (square feet of application area per linear foot) of 4.0 ft<sup>2</sup>/ft
- 2) 3-bedroom home (250 GPD) in soil design subgroup B-1 soils (application rate of 0.6 GPD/ft<sup>2</sup>)
- 3)  $([250 \text{ GPD}]/[0.6 \text{ GPD}/\text{ft}^2])/(4.0 \text{ ft}^2/\text{ft}) = 105$  linear feet of gravelless trench product

- b. Disposal trench length is calculated the same way for both gravelless pipe and gravelless chamber products (attention must be paid to specific product application ratings).
  - c. Width of trench depends on the manufacturer's installation requirements for each approved product.
2. Individual lines in soil design group C soils should be as long as possible, not exceeding the 100-foot maximum.

#### **4.11.4 Construction**

1. The trench should follow the contour of the land.
2. Trench excavations should not be less than 8 inches wide and no more than 36 inches wide. Width dimensions will depend on the manufacturer's installation instructions.
3. Pipe must be installed level. A transit, engineer's level, or surveying station is required.
4. Effluent piping entering gravelless chambers should be installed into the highest inlet hole available on the chamber end cap.
5. An inspection port/sludge sump should be installed at the end of each line.
6. Large diameter gravelless pipe products should be covered with geotextile fabric, untreated building paper, or a 3 inch layer of straw unless the product has a built in filter fabric in the design.

Gravelless chambers are not required to be covered with geotextile fabric, untreated building paper, or straw unless specifically required by the manufacturer.

7. Care must be taken not to overexcavate trench width wider than the product width. If overexcavation is unavoidable hand backfilling of trench should be performed up to the product height and fill should be walked in to ensure sidewall support of the product.

## 4.12 Gray Water Sump

Revision: April 3, 2013

Installer registration permit: Property owner or standard and basic

Licensed professional engineer required: No

### 4.12.1 Description

A gray water sump is a receptacle designed to receive hand-carried gray water that is connected to a disposal trench in soil.

### 4.12.2 Approval Conditions

1. Limited to serve facilities such as recreation parks, camp sites, seasonal dwellings, or construction sites.
2. Gray water flow is limited to 10 GPD per unit.
3. Gray water may not be piped to the disposal system.
4. Soils at the disposal site must be approved by the permit-issuing agency before approval of the permit application.
5. Seepage chamber must be located a minimum of 100 feet from any surface water. Separation from limiting layers will be the same as for standard systems.

### 4.12.3 Construction

1. General details:  
Figure 4-17 shows a cross section of a gray water sump system.
2. A disposal trench may be substituted for a seepage chamber.
3. A sign must identify the disposal system at public places. Letters should be at least 3 inches high.

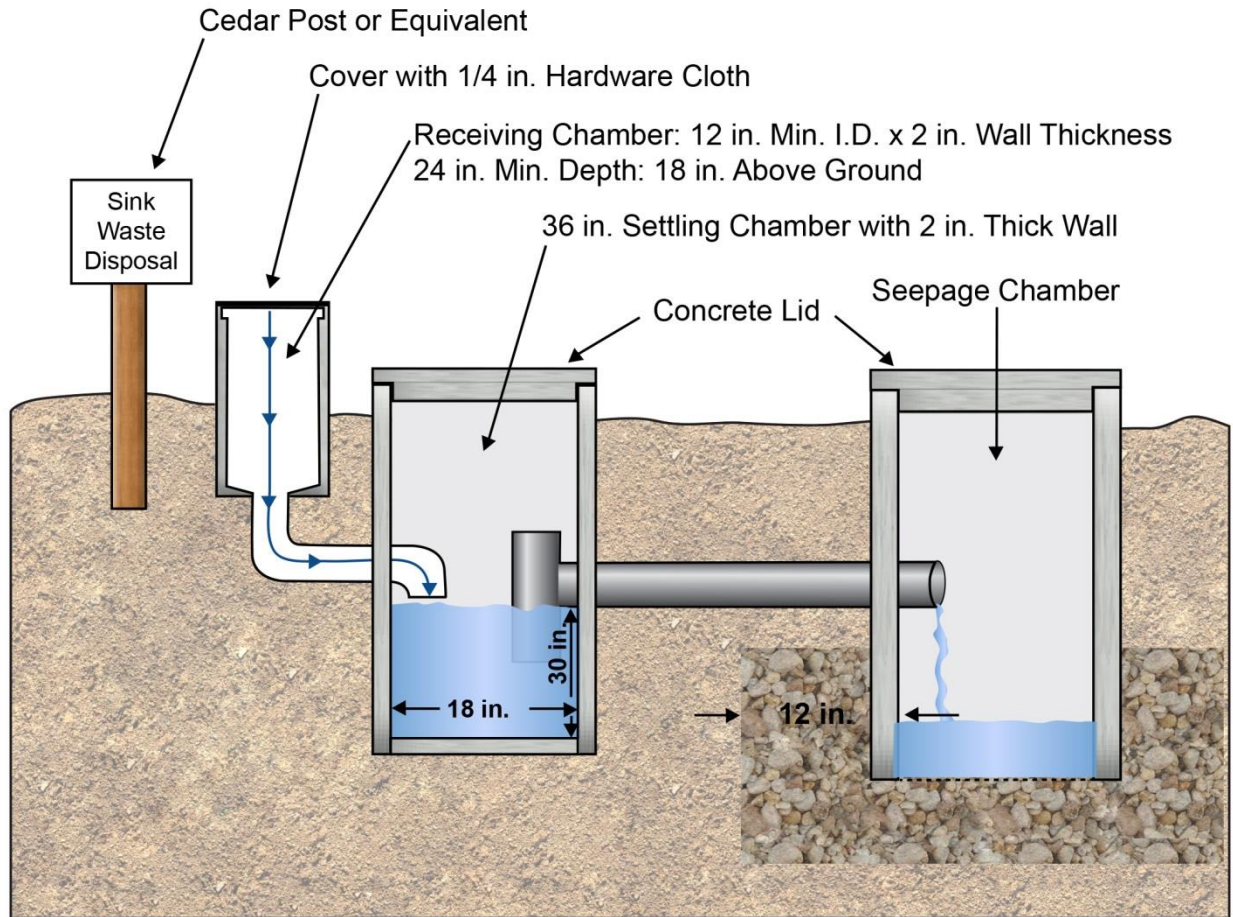

Figure 4-17. Cross section of gray water sump system.

## 4.13 Gray Water System

Revision: May 6, 2020

Installer registration permit: Property owner or standard and basic (complex if pressurized)

Licensed professional engineer required: No (yes if pressurized)

### 4.13.1 Description

A gray water system is used to distribute gray water in the root zone of landscaping. Gray water is domestic wastewater that consists of used water from bathtubs, showers, and sinks used only for hand washing. Other acceptable gray water sources may be determined on a case-by-case basis as long as the source does not come into contact with blackwaste or food products (e.g., drinking fountain or ice machine). Gray water does not include wastewater from toilets, kitchen sinks, water softeners, dishwashers, or clothes washing machines, or nondomestic wastewater sources. A gray water system consists of a separate plumbing system for the approved gray water sources from the nonapproved wastewater sources, a dosing chamber or tank with surge capacity to temporarily hold large drain flows, a filter to remove particles that could clog the irrigation system, a pump to move the gray water from the surge tank to the dosing chamber to the drip irrigation field (if necessary), and a drip irrigation system or mini-leachfield to distribute the gray water.

### 4.13.2 Approval Conditions

1. Gray water treatment system components must meet all the effective soil depths and separation distance criteria required by IDAPA 58.01.03 for standard systems.
2. Minimum irrigation area shall be based on the landscape area calculated in Equation 4-11 and/or Equation 4-12.
3. Separate plumbing designs for the gray water and other wastewater sources will need to be approved by the Idaho Division of Building Safety, Plumbing Program.
4. Gray water tanks for gravity flow systems must be watertight, noncorrosive, and included on the approved product lists in sections 5.2 and 5.3.
5. Dosing chambers shall meet the requirements of section 4.19.3.4 and should account for surge flows and storage to meet the irrigation needs of the system:
  - a. Must have an overflow to the subsurface sewage disposal system with an invert elevation lower than the inlet or pressure pipe outlet of the chamber.
  - b. High level audio and visual alarms are not required.
6. The system must be designed by a PE licensed in Idaho if using drip or pressure distribution.
7. The design engineer shall provide an O&M manual for the system to the health district before permit issuance.
8. The drip distribution (irrigation) system shall meet the requirements of section 4.5 for pretreated effluent drip distribution systems except that a pretreatment system is not required.
9. Mini-leachfields shall meet the design requirements for drainfields outlined in IDAPA 58.01.03.008, except for those deviations allowed in Table 4-10, and shall use geotextile fabric for the drainrock-soil barrier.

- 10 Gray water may not be used to irrigate vegetable gardens.
11. Gray water shall not be applied on the land surface or be allowed to reach the land surface.
12. All wastewater generated that is not approved to be discharged to the gray water system shall either discharge to a full-sized subsurface sewage disposal system or collection system for a private or public municipal wastewater treatment plant. Because the gray water system is intended for irrigation and not year-round disposal, the subsurface sewage disposal system must be designed for *all* wastewater flows including both gray water and black water wastes.

**Table 4-10. Gray water gravity flow mini-leachfield design criteria.**

<b>Mini-leachfield Design Criteria</b>	<b>Minimum</b>	<b>Maximum</b>
Number of drain lines per irrigation zone	1	—
Length of each perforated line	—	100 feet
Distribution area square footage	—	1,500
Bottom width of trench	6 inches	18 inches
Total depth of trench	12 inches	18 inches
Spacing of line, center-to-center	3 feet	4 feet
Depth of earth cover over lines	6 inches	12 inches
Depth of aggregate over pipe	2 inches	—
Depth of aggregate beneath pipe	2 inches	—
Grade on perforated pipe	Level	1 inch/100 feet

### 4.13.3 Design Requirements

1. Gray water flows are determined by calculating the maximum number of occupants or visitors in the wastewater-generating structure. Residences shall be based on the first bedroom with two occupants and each bedroom thereafter with one occupant unless higher usage is proposed by the applicant.
2. Estimated daily gray water flows for each occupant are shown in Table 4-11:

**Table 4-11. Gray water flow by fixture type connected to system in gallons per person per day.**

<b>Fixture</b>	<b>Gallons/Person/Day</b>
Shower/bath	18
Hand sinks (faucets)	12
Other	Case-by-case determination

Multiply the number of occupants and visitors by the estimated gray water flow for the fixtures proposed to be connected to the gray water system.



For example: A three-bedroom house is designed for four people. The house has showers and hand sinks, thus each occupant is assumed to produce 30 GPD of gray water, resulting in a total of 120 GPD.

- The formula shown in Equation 4-11 is used to estimate the square footage of landscape to be irrigated:

$$LA = \frac{GW}{ET \times PF \times 0.62}$$

**Equation 4-11. Landscaped area needed for gray water produced.**

where:

- GW = estimated gray water produced (gallons per week)
- LA = landscaped area (square feet)
- ET = evapotranspiration (inches per week)
- PF = plant factor, based on climate and type of plants either 0.3, 0.5, or 0.8
- 0.62 = conversion factor (from inches of ET to gallons per week)

For example: If ET = 2 inches per week, and lawn grasses are grown with a PF of 0.8 (high water using) then the landscaped area is equal to:

$$LA = (120 \text{ GPD} \times 7 \text{ days}) / (2 \times 0.8 \times 0.62) = 847 \text{ ft}^2 \text{ of lawn.}$$

- An alternative to using gray water for lawns is to irrigate landscape plants. A plant factor depends on the type of plants watered, an ET rate, and plant canopy. Table 4-12 is used to calculate square footage of landscape plants that can be irrigated with gray water.

**Table 4-12. Gray water application rates for landscape plants.**

Evapotranspiration (inches per week)	Relative Water Need of Plant (plant factor)	Gallons per Week		
		200 ft <sup>2</sup> Canopy	100 ft <sup>2</sup> Canopy	50 ft <sup>2</sup> Canopy
1	Low water using 0.3	38	19	10
	Medium water using 0.5	62	31	16
	High water using 0.8	100	50	25
2	Low water using 0.3	76	38	19
	Medium water using 0.5	124	62	31
	High water using 0.8	200	100	50
3	Low water using 0.3	114	57	28
	Medium water using 0.5	186	93	47
	High water using 0.8	300	150	75

Note: square feet (ft<sup>2</sup>)

Gallons per week (GPW) calculation for this chart was determined with Equation 4-12:

$$\text{Gray water flow (GPW)} = ET \times \text{plant factor} \times \text{area} \times 0.62 \text{ (conversion factor)}$$

**Equation 4-12. Gallons per week needed for irrigated plants.**

This formula does not account for irrigation efficiency. If the irrigation system does not distribute water evenly, extra water will need to be applied.

For example: A three-bedroom home will produce 840 GPW (7 days x 120 GPD). If ET = 2 inches per week, then with the 840 gallons of gray water a homeowner could irrigate the following :

- a. Four small fruit trees: 4 x 50 = 200 gallons (high water using, 50-foot canopy)
- b. Six medium shade trees: 6 x 62 = 372 gallons (medium water using, 100-foot canopy)
- c. Eight large shrubs: 8 x 31 = 248 gallons (medium water using, 50-foot canopy)
- d. Total water use per week: 820 GPW

**4.13.4 Other Requirements**

1. The Uniform Plumbing Code (UPC) Gray Water Standards require that all gray water piping be marked *Danger—Unsafe Water*.
2. Valves in the plumbing system must be readily accessible, and backwater valves must be installed on dosing chamber drain connections to sanitary drains or sewer piping. Ball valves are recommended to be used in the system. Finally all piping must be downstream of water-seal type trap(s). If no such trap exists, an approved vented running trap shall be installed upstream of the connection to protect the building from possible waste or sewer gasses.
3. Dosing chamber or tank must be vented, and the tank drain and overflow gravity drain must be permanently connected to the structure’s septic tank or sewer line. The drain and overflow drain shall not be smaller in diameter than the inlet pipe.
4. Filters with a minimum flow capacity of 25 GPM are required.

*Notes:*

1. The plants listed in Table 4-13 are tolerant of sodium and chloride ions or have been reported to do well under gray water irrigation.
2. Different types of media can be used in gray water filtration. These include nylon or cloth filters, sand filters, and rack or grate filters.

**Table 4-13. Sodium and chloride tolerant plants.**

Agapanthus	Cottonwood	Honeysuckle	Olive	Rosemary
Arizona cypress	Crape myrtle	Italian stone pine	Pfitzer bush	Strawberry clover
Bermuda grass	Deodar cedar	Juniper	Purple hopseed bush	Star jasmine
Bougainvillea	Evergreen shrubs	Oaks	Redwoods	Sweet clover

---

Carpet grass	Holly	Oleander	Rose
--------------	-------	----------	------

---

Figure 4-18 shows a single-tank gravity gray water system, and Figure 4-19 shows a single-tank pumped gray water system.

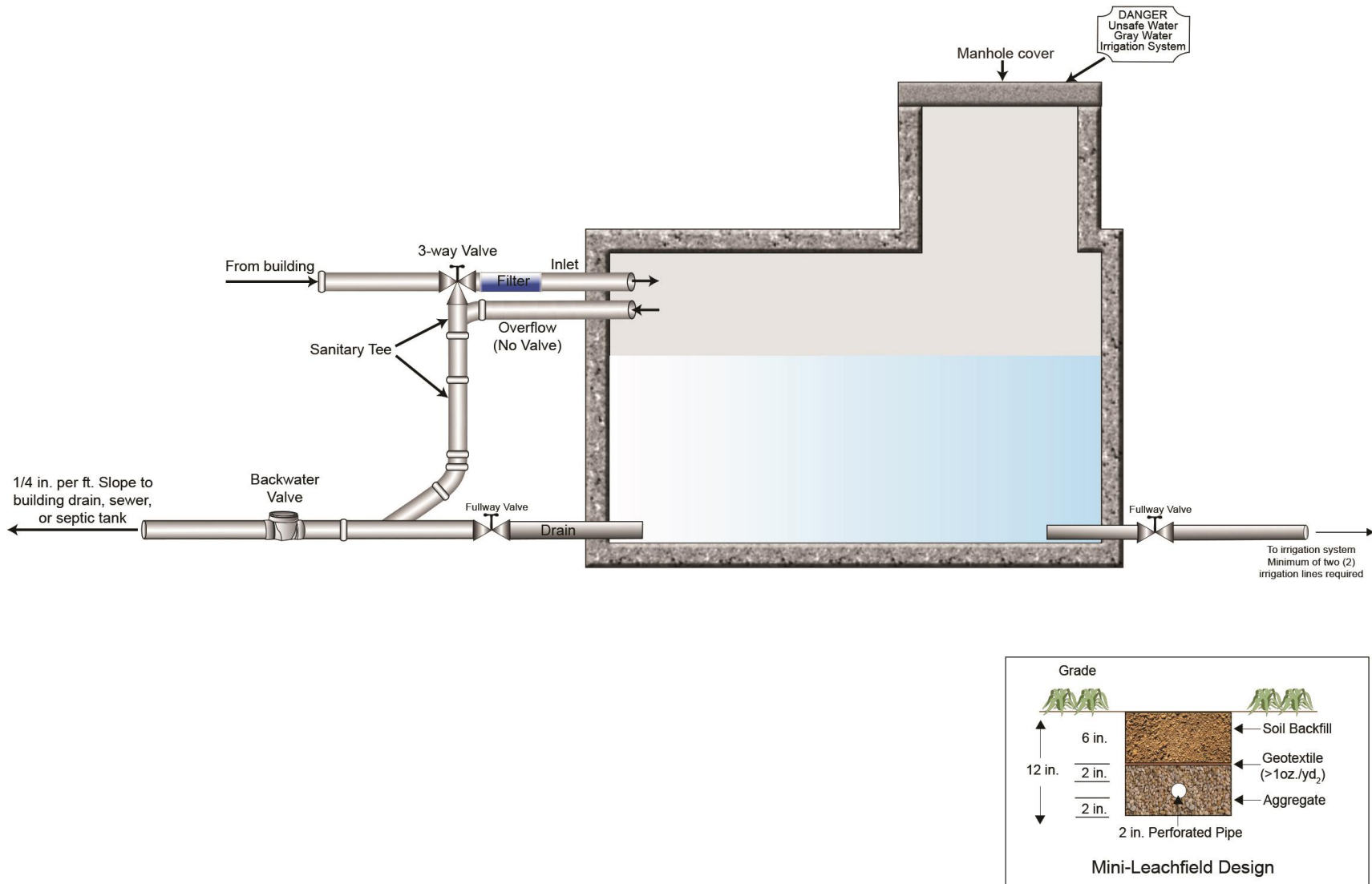

Figure 4-18. Gray water system (single-tank gravity).

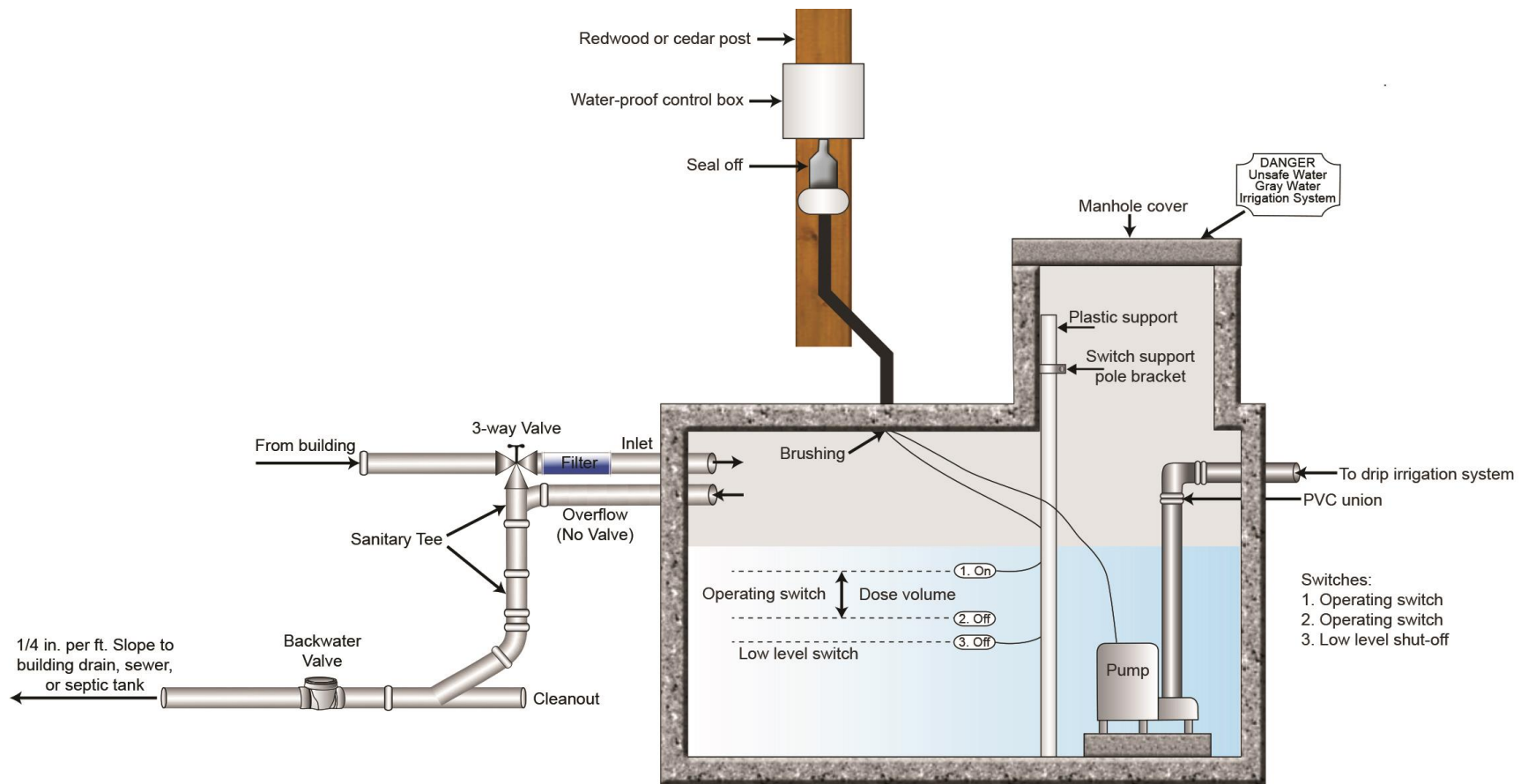

Figure 4-19. Gray water system (single-tank pumped).

## 4.14 Emergency Holding Tank

Revision: April 18, 2013

Installer registration permit: Property owner or standard and basic

Licensed professional engineer required: No

### 4.14.1 Description

An emergency holding tank is a sealed septic tank for the temporary storage of water-carried sewage. The septic tank is pumped periodically, and the sewage is disposed of at a secondary treatment site.

### 4.14.2 Approval Conditions

1. An emergency situation exists and installation of a holding tank is necessary to prevent a potential public health hazard.
2. A management entity or arrangement to provide maintenance and pumping of the tank by a permitted septic tank pumper must be approved by the Director. Such an entity or arrangement must be in operation prior to the emergency holding tank permit being issued.
3. The arrangement and permitted septic tank pumper shall be provided in writing prior to issuing the emergency holding tank permit.
4. Emergency holding tanks may not be approved for new wastewater generating structures.
5. Emergency holding tanks may not be approved for permanent, year-round structures except temporarily to satisfy approval condition 1.
6. Emergency holding tanks may not be located in a floodway.
7. The emergency holding tank permit shall specify a specific date or specific predetermined circumstance for the abandonment of the emergency holding tank (IDAPA 58.01.03.005.13). The specific date or predetermined circumstance shall be provided in writing and be signed by the permit applicant prior to permit issuance (IDAPA 58.01.03.005.13).

### 4.14.3 Design Requirements

1. Emergency holding tanks must meet the distance limitations of a septic tank (IDAPA 58.01.03.007.17).
2. Emergency holding tanks must meet the septic tank design and construction standards as described in IDAPA 58.01.03.007. Requirements of IDAPA 58.01.03.007.07, 58.01.03.007.08, 58.01.03.007.19, and 58.01.03.007.22 shall be exempt from the design and construction standards of an emergency holding tank.
3. If the emergency holding tank is a modified septic tank, the outlet opening shall be sealed.
4. A manhole extension shall be brought to finished grade at the inlet end of the emergency holding tank.
5. An emergency warning system shall be required to be installed to indicate when the emergency holding tank is two-thirds full.

6. The tank shall meet the volume requirements of a septic tank, except that no tank shall be less than 1,500 gallons.

## 4.15 Individual Wastewater Incinerator

Revision: August 18, 2016

Installer registration permit: Property owner or standard and basic

Licensed professional engineer required: No

### 4.15.1 Description

Housed within a dwelling or other structure, individual wastewater incinerators store and incinerate wastewater and/or blackwaste. Incineration is facilitated by petroleum fuels or electricity.

### 4.15.2 Approval Conditions

1. Water under pressure shall not serve the dwelling unless:
  - a. A public sewer connection is provided to the dwelling, or
  - b. A full-size subsurface sewage disposal system is installed, or
  - c. An incinerator capable of combusting the daily design flow for the dwelling's sewage blackwater and gray water is installed.
    - 1) Water under pressure for dwellings served by an incinerator is limited to storage tanks that are not continuously or automatically filled by natural sources (e.g., springs) or mechanical sources (e.g., pumped wells and surface water).
    - 2) Daily design flow shall be per IDAPA 58.01.03.007.08.
    - 3) Low flow water fixtures shall be installed throughout the dwelling.
    - 4) The installation permit shall include a statement: "Incinerator must be maintained and operable at all times the dwelling is occupied until such time that the dwelling is connected to an approved wastewater disposal system. The wastewater holding tank is only approved for temporary storage of wastewater prior to discharge to the incinerator and shall not be used as a permanent pump-and-haul holding tank."
2. Nonwater carried incinerator:
  - a. May be located in structures other than a dwelling if the structure is constructed to meet the requirements of a pit privy building (section 4.17.4).
  - b. Units are restricted to disposal of human feces and urine and shall be installed and operated according to the manufacturer's recommendations.
3. Water carried incinerator:
  - a. Wastewater holding tanks shall have a volume two times the capacity of the water supply tank and shall not be less than two times the maximum incineration volume of the installed unit.
  - b. Wastewater holding tank shall not be used as a permanent holding tank that necessitates pumping and hauling of the wastewater by a pumper truck.
4. Individual wastewater incinerator models must be approved by DEQ before installation (section 5.5).
5. Incinerators shall be installed according to the manufacturer's specifications.



6. Proper electrical, plumbing, and gas line permits must be obtained through the Idaho Division of Building Safety or any other applicable regulatory agency for the area the incinerator is installed within.

#### 4.15.3 Design Requirements

1. All materials used in construction of an incinerator toilet must be durable and easily cleaned. Styrene rubber, PVC, and fiberglass are examples of acceptable materials for toilet components.
2. The combustion area and flue must be constructed of heat-resistant, noncorrosive metals.
3. The design must demonstrate adequate resistance to internal and external stresses.
4. All mechanical and electrical components should be designed to operate safely and be capable of providing continuous service under reasonably foreseen conditions such as extremes in temperature and humidity.
5. For standard dwellings, the incinerator or toilet unit must be capable of accommodating full-time use based on two people in the first bedroom and one person in every other bedroom. Full-time use for other structures or dwellings will be determined on actual capacity and projected visitors per day.
6. Continuous positive ventilation of the storage or treatment chamber must be provided to the outside.
  - a. Ventilation components should be independent of the other structure ventilation systems.
  - b. Venting connections must not be made to room vents or to chimneys.
  - c. All vents must be designed to prevent flies and other insects from entering the treatment chamber.

*Note:* Toilets, as plumbing fixtures, are under the regulation of the Idaho Division of Building Safety, Plumbing Program. Current plumbing code prohibits using incinerator toilets without the permission of the health district. Proof of permission will be provided through a permit issued by the health district. Some incinerators may require significant volumes of fuel and long operation times to operate at peak capacity.

#### 4.15.4 Operation and Maintenance

1. The toilet and/or incinerator should be inspected regularly to check the quantity of incinerated waste for removal needs.
2. The toilet and/or incinerator components should be inspected and maintained according to the manufacturer's recommendations.

## 4.16 Individual Lagoon

Revision: September 18, 2014

Installer registration permit: Complex

Licensed professional engineer required: Yes

### 4.16.1 Description

An individual lagoon is a pond sealed with a natural or synthetic liner into which sewage from a household or small business is discharged. Bacteria digest the solids in the presence of oxygen, and the liquid is evaporated into the atmosphere.

### 4.16.2 Approval Conditions

1. Lagoons are applicable only in areas of Idaho where the annual evaporation exceeds the annual precipitation.
2. The lagoon may not be placed within 200 feet of the owner's property line as measured from the toe of the exterior slope.
3. The bottom of the finished lagoon must not be constructed within the following:
  - a. 6 inches of the maximum seasonal high ground water
  - b. 2 feet of the normal high ground water level
  - c. 2 feet of bedrock
4. Site must be located in an area of maximum exposure to the sun and wind.
5. Lagoons shall not be installed in a floodway.
6. Slope must not be greater than 12%.
7. Lagoons are restricted from use in areas where such systems may have an ice cover for more than 3 months.
8. A source of makeup water with a backflow prevention system between the source and lagoon must be readily available.
9. Lot size should be at least 10 acres but in no case should be less than 5 acres. If the lot is less than 10 acres, a variance must be required.
10. This design is for individual residential dwellings or small commercial businesses that only discharge domestic wastewater. Facilities discharging nondomestic wastewater do not qualify for an individual lagoon under this guidance. Owners of facilities proposing to discharge nondomestic wastewater to a lagoon need to contact DEQ and follow the "Wastewater Rules" (IDAPA 58.01.16).
11. System designs that meet the definition of a central system (IDAPA 58.01.03.003.08) do not qualify for an individual lagoon under this guidance. Owners of central systems that are proposing to discharge into a lagoon need to contact DEQ and follow the "Wastewater Rules" (IDAPA 58.01.16).
12. The system shall be designed by a PE licensed in Idaho.

### 4.16.3 Design Requirements

1. Area of the lagoon at the 2-foot minimum depth is first determined by the net evaporation of the area. Equation 4-13 gives the calculation for horizontal area.

$$A = \frac{1.2 \times \text{yearly flow (in cubic feet)}}{\text{Annual net moisture (in feet)}} \quad \text{Equation 4-13. Lagoon horizontal area (square feet).}$$

where:

Yearly flow in cubic feet = (GPD x 365 days) x (7.48 gallons/ft<sup>3</sup>).

Annual net moisture as determined from a water mass balance beginning in October.

2. Total liquid depth:

2-foot minimum depth + 2 foot freeboard + annual net moisture as determined by a water mass balance.

3. The top of the lagoon embankment shall be at least 1 foot above the established flood elevation for the site.
4. The lagoon shall be lined with material that is watertight and demonstrates at least a 20-year service life. The following requirements must be met for flexible membrane liners:
  - a. Have properties equivalent to or greater than 30-mil PVC.
  - b. Have field repair instructions and materials provided to the purchaser of the liner.
  - c. Have factory fabricated boots for waterproof field bonding of piping to the liner.
  - d. Liner must be placed against smooth, regular surfaces free of sharp edges, nails, wire, splinters, or other objects that may puncture the liner. A 4-inch layer of clean sand should provide liner protection.
5. The lagoon shall not exceed a maximum leakage rate of 500 gallons per acre of lagoon surface area per day.
6. Minimum dike embankment details:
  - a. Inner and outer slope: 3 horizontal to 1 vertical (3:1)
  - b. Inner slopes should not be flatter than 4 horizontal to 1 vertical (4:1)
  - c. Top of the embankment width: 4 feet minimum.
7. The effluent discharge inlet to the lagoon must be placed near its center with a concrete splash pad constructed around the inlet.
8. A water depth gauge clearly visible from the edge of the lagoon should be located near the concrete splash pad.
9. A cleanout must be placed on the influent line at a point above the lagoon's maximum liquid elevation.
10. If the sewage is pumped to the lagoon, a valve must be installed in the line that will permit repairs without draining the lagoon and will prevent backflow of effluent to the pumping chamber.
11. The lagoon must be fenced to exclude children, pets, and livestock. A sign indicating *Danger—Human Sewage* is recommended.

#### 4.16.4 Construction

1. All fill must be compacted to at least 95% standard Proctor density.
2. All soil used in constructing the pond bottom and dike cores shall be relatively impervious, incompressible and tight, and compacted to at least 95% standard Proctor density.

#### 4.16.5 Inspections

1. A preconstruction conference should be held between the health district, installer, and responsible charge engineer.
2. The site must be inspected when the cells have been excavated and formed, and prior to installation of the lagoon liner. Compaction test results for all fill material, dikes, and the lagoon bottom shall be provided at this time.
3. The site must be inspected after the impervious liner is placed and prior to filling the lagoon.
4. Individual lagoons shall be seepage tested by a PE or PG licensed in Idaho, or by individuals under their supervision.
  - a. Seepage testing procedures, to demonstrate seepage rate compliance, must be submitted to DEQ for review and approval prior to conducting required seepage testing (see <http://www.deq.idaho.gov/water-quality/wastewater/lagoon-seepage-testing.aspx> for more information).
  - b. This is a one-time seepage test that must be performed before the lagoon is placed into service.
5. The responsible charge engineer should conduct as many inspections as necessary to verify that the system and components are in compliance with the engineered plans.
6. The responsible charge engineer shall provide the health district with a written statement that the system was constructed and functions in compliance with the approved plans and specifications. Additionally, the responsible charge engineer shall provide as-built plans to the health district if any construction deviations occur from the permitted construction plans (IDAPA 58.01.03.005.15).

#### 4.16.6 Operation and Maintenance

1. The lagoon design engineer shall provide a copy of the system's OMM procedures to the health district as part of the permit application and prior to subsurface sewage disposal permit issuance (IDAPA 58.01.03.005.04.k).
2. The lagoon must be kept filled with at least 2 feet of liquid.

Annual maintenance and testing of the backflow prevention device installed on the makeup water supply line shall be performed and completed according to the manufacturer's recommendations.
3. Embankments must be stable and maintained to avoid breach, overflow, aesthetic nuisance, or disturbance to the lagoon operation.
4. Permanent vegetation shall be maintained on the top and outer slopes of the embankment except where a foot or vehicle path is in use.

5. Woody vegetation should be removed from the embankments; grasses should be mowed; and other vegetation should be maintained regularly.
6. Weeds and other vegetation must not be allowed to grow in the lagoon.
7. Floating aquatic weeds must be physically removed on a regular basis.
8. The fence and all gates must be maintained to exclude animals, children, and other unwanted intrusion.
9. Directions for repair of the impervious liner should be included.
10. Directions on how to address potential odor issues from the lagoon should be described.

## 4.17 Pit Privy

Revision: March 20, 2015

Installer registration permit: Property owner or standard and basic

Licensed professional engineer required: No

### 4.17.1 Description

A pit privy is a building that contains a toilet facility located over an excavation in natural soil for the disposal of blackwaste.

### 4.17.2 Approval Conditions

1. Surface water will be excluded.
2. Pit privies should not be located in floodways.
3. Effective soil depths (IDAPA 58.01.03.008.02.c) and separation distances (IDAPA 58.01.03.008.02.d) shall be met from the pit excavation with the following exceptions:
  - a. Clay soils of all types are acceptable.
  - b. Impermeable layer restrictions are waived.
4. Structures on the property served by water under pressure shall install a subsurface sewage disposal system.
5. The pit shall be abandoned when the blackwaste comes within 16 inches of the ground surface.
6. The pit privy installation permit shall contain a statement that requires the pit privy to be abandoned upon the installation of a subsurface sewage disposal system.

### 4.17.3 Pit Construction Requirements

1. Area where the privy is placed must be
  - a. Firm and level for at least 12 inches from the sides of the building.
  - b. Shall be at least 12 inches above the highest ground elevation as measured 18 inches from the sides of the building.
  - c. Shall be graded at a maximum slope of 3:1 starting 18 inches from the sides of the building
2. Pit dimensions should be at least 3 feet wide on all sides and 4 feet deep but no deeper than 6 feet below original ground level.
3. Pit cribbing, when required, shall
  - a. Fit firmly.
  - b. Be in uniform contact with the earth walls on all sides.
  - c. Rise at least 6 inches above the original ground line and descend to the full depth of the pit.

### 4.17.4 Building Construction Requirements

1. The privy building shall be firmly anchored and rigidly constructed.

2. All openings, spaces, and cracks that would permit flies to access the pit must be no wider than 1/16 inch. This would include doors and seats when closed.
3. Doors shall be self-closing.
4. The privy building shall be ventilated with two screened openings that each have a cross-sectional area of 1 ft<sup>2</sup> per seat located at the top of opposite walls.
5. All gaps larger than 1/16 inch shall be screened with a maximum 16-mesh screen size.
6. The pit must be vented through the building with a screened vent stack having a minimum diameter of 3 inches per seat and extending at least 12 inches above the roof of the building.
7. The seat opening shall be at least 12 inches from the side walls in all privies and spaced so that there is at least 24 inches between seats in multiple-seat installations.
8. The seat shall have an inside clearance of at least 21 inches from the front wall and 24 inches from the rear wall of the privy.
9. The seat top shall not be less than 12 inches or more than 20 inches above the floor.
10. The floor and toilet riser shall be built of nonabsorbent and sealed material or tongue-and-groove lumber and in a manner to deny access to insects.
11. The seat shall be constructed of nonabsorbent material.

#### **4.17.5 Abandoning a Pit Privy**

1. The privy building should be dismantled, and the portions of the building that may have come into contact with human sewage should be disposed of in a landfill.
2. The pit shall be filled with soil that is free of rock and graded to allow for about 12 inches of settling.
3. The site should be marked and protected from traffic or excavation activities.

## 4.18 Portable Sanitation Units

Revision: March 20, 2015

Installer registration permit: Not applicable

Licensed professional engineer required: No

### 4.18.1 Description

Portable sanitation units are prefabricated, portable, self-contained toilets that may be housed in trailers or as stand-alone units used for special or temporary events, construction sites, parks, and other events or locations with restroom needs.

### 4.18.2 Approval Conditions

1. Permanent sewage disposal facilities are not available.
2. All units must be serviced by a pumper with equipment that is permitted through a health district under IDAPA 58.01.03.
3. Units must be manufactured to meet the most current version of ANSI standard Z4.3.
4. Chemicals and biologicals, if used in the waste container, must be compatible with the final disposal site. Chemicals considered hazardous wastes must not be used.
5. Toilets shall contain an adequate supply of toilet paper and hand sanitizer (potable water hand-washing stations may be supplied instead of hand sanitizer).

### 4.18.3 Units Required

1. Table 4-14 and Table 4-15 provide work site requirements.
2. Table 4-16 provides special event requirements.
3. Campouts and overnight event requirements are at least 1 unit for every 50 participants.
4. The following should be taken into consideration when selecting the number of units for an event:
  - a. If the units are serving an event with food and beverage service 10%–20% more units should be added to the recommended totals in Table 4-15.
  - b. Traffic flow.
  - c. Outside temperature (i.e., on warmer days attendees will take in more liquids).
  - d. Special needs (e.g., changing tables, children use, handicapped accessibility).
  - e. Urinals may be substituted for one-third of the total units specified if facilities will not serve women.



**Table 4-14. Portable units required per number of employees if the units are serviced once per week.**

Total Number of Employees	Minimum Number of Units (8-hour days/40-hour week)
1–10	1
11–20	2
21–30	3
31–40	4
Over 40	1 additional unit for each 10 additional employees.

**Table 4-15. Portable units required per number of employees if the units are serviced more than once per week.**

Total Number of Employees	Minimum Number of Units (8-hour days/40-hour week)
1–15	1
16–35	2
36–55	3
56–75	4
76–95	5
Over 95	1 additional unit for each 20 additional employees.

**Table 4-16. Portable unit requirements for number of people per event hours based on a 50/50 mix of men and women.**

Number of People	Number of Hours for the Event									
	1	2	3	4	5	6	7	8	9	10
0–500	2	4	4	5	6	7	9	9	10	12
501–1,000	4	6	8	8	9	9	11	12	13	13
1,001–2,000	5	6	9	12	14	16	18	20	23	25
2,001–3,000	6	9	12	16	20	24	26	30	34	38
3,001–4,000	8	13	16	22	25	30	35	40	45	50
4,001–5,000	12	15	20	25	31	38	44	50	56	63
5,001–10,000	15	25	38	50	63	75	88	100	113	125
10,000–15,000	20	38	56	75	94	113	131	150	169	188

Number of People	Number of Hours for the Event									
	1	2	3	4	5	6	7	8	9	10
15,000–20,000	25	50	75	100	125	150	175	200	225	250
20,000–25,000	38	69	99	130	160	191	221	252	282	313
25,000–30,000	46	82	119	156	192	229	266	302	339	376
30,000–35,000	53	96	139	181	224	267	310	352	395	438
35,000–40,000	61	109	158	207	256	305	354	403	452	501
40,000–45,000	68	123	178	233	288	343	398	453	508	563
45,000–50,000	76	137	198	259	320	381	442	503	564	626

#### 4.18.4 Service Requirements

1. Work site units should be serviced weekly.
2. Special events with more than 500 people in attendance should have a service attendant on site during the event.
3. The employer, event promoter, or manager must be responsible for the hygiene and use of each portable sanitation unit.
4. Units should be serviced and removed from a site as soon as possible after the completion of an event.
5. All equipment used to pump or transport sewage from a portable sanitation unit must be permitted by an Idaho health district under the requirements of IDAPA 58.01.03.
6. All sewage removed from a portable sanitation unit must be disposed of at a location approved by the health district or DEQ through the pumper’s permit application.

## 4.19 Pressure Distribution System

Revision: August 6, 2020

Installer registration permit: Complex

Licensed professional engineer required: Yes

### 4.19.1 Description

A pressure distribution system is a low-pressure system of small-diameter perforated plastic pipe laterals, manifold, pressure transport line, dosing chamber, and a pump or siphon. The pressure distribution system is used when it is desirable to:

1. Maintain a uniform application of effluent across the drainfield.
2. Treat and dispose of effluent in the uppermost levels of the soil profile.
3. Aid in mitigating the potential contamination of ground water.
4. Improve the performance and increase the life span of a drainfield.

### 4.19.2 Approval Conditions

1. Pressure distribution shall be used in drip distribution, pressurized gray water systems, sand mounds, intermittent sand filters, recirculating gravel filters, drainfields that exceed 1,500 ft<sup>2</sup> in total trench bottom (IDAPA 58.01.03.008.4), and large soil absorption systems.
2. Pressure distribution may be used in in-trench sand filters to obtain a reduced separation distance to permeable limiting layers, standard or basic alternative systems at the applicant's request, and in environmentally sensitive areas.
3. Geotextile filter fabrics are required to be used for cover over drainfield aggregate in pressure distribution systems.
4. All design guidance related to dosing chambers, in-tank pumps, and pump to gravity distribution systems contained herein shall be followed for any alternative system using these components regardless of whether the drainfield is pressurized or not (IDAPA 58.01.03.004.10).
5. The design guidance provided herein for piping, pump, and dosage requirements is meant to be a simple design strategy and is not intended to supplant or limit engineering design for these components and systems.
6. Plans for systems with designs different than those provided herein and where daily wastewater flows exceed 2,500 gallons shall be reviewed by DEQ.
7. The system must be designed by a PE licensed in Idaho.
8. The design engineer shall provide an O&M manual for the system to the health district prior to permit issuance.
9. The following guides are recommended for use in pressure system design:

Otis, R.J. 1981. *Design of Pressure Distribution Networks for Septic-Tank Absorption Systems*. Madison, WI: University of Wisconsin. Small Scale Waste Management Project Publication No. 9.6. [www.soils.wisc.edu/sswmp/pubs/9.6.pdf](http://www.soils.wisc.edu/sswmp/pubs/9.6.pdf).

Converse, J.C. 2000. *Pressure Distribution Network Design*. Madison, WI: University of Wisconsin. Small Scale Waste Management Project Publication No. 9.14.  
[www.soils.wisc.edu/sswmp/pubs/9.14.pdf](http://www.soils.wisc.edu/sswmp/pubs/9.14.pdf).

### 4.19.3 Design Requirements

Many considerations need to be made in the design of a pressure distribution system based on site- and flow-specific characteristics. These characteristics will affect several system components depending on each specific design scenario. Typical system design should occur based on the following design procedures:

1. Layout the distribution lateral network.
2. Select the orifice size and spacing.
3. Determine the lateral diameter compatible with the orifice size and spacing.
4. Determine the lateral discharge rate.
5. Determine the manifold diameter based on the number, spacing, and discharge rate of the laterals.
6. All pipe velocities are recommended to be at least 2 feet per second.
7. Determine the total internal volume of the manifold and lateral.
8. Determine the desired dose volume and rate.
9. Calculate the static and dynamic pressure requirements of the piping network and document this in a system performance curve.
10. Select a pump based on the dose volume, discharge rate, friction losses, and total head of the system and the pump manufacturer-supplied performance curve.
  - a. Plot the pump performance curve on the system performance curve. The point where the pump curve crosses the system performance curve is where that pump will operate.
  - b. The crossing point must exceed the specified minimum operating system pressure and should occur near the center of the pump performance curve.
11. Select the correct size of dosing chamber based on the system design flow and pump selection.
12. Select the pump controls.

#### 4.19.3.1 Piping

Pressure distribution system piping typically consists of several sections including transport piping, manifold, and laterals. Each of these piping selections have components and design factors that are unique to that particular section.

##### *Lateral Piping*

Lateral piping is placed within the drainfield and is used to evenly distribute wastewater effluent to the drainfield infiltrative surface. To distribute the effluent, several small diameter orifices are drilled into each lateral. Recommendations for the design of lateral piping and the associated orifices are included below.

### *Distribution Laterals*

1. Lateral length should be shorter than the trench length by at least 6 inches but not more than 36 inches.
2. Laterals in trenches should be placed equidistant from each trench sidewall and from each other.
3. Lateral spacing in beds is recommended to be equal to orifice spacing.
  - a. The outside laterals should be placed at one-half the selected lateral spacing from the bed's edge.
  - b. Laterals should not be placed farther apart than 3 feet on center in bed designs and should not be placed farther than 1.5 feet from the bed's edge regardless of orifice spacing.
  - c. The maximum lateral spacing in sand mounds, intermittent and in-trench sand filters, and recirculating gravel filters is 2.25 feet.
4. Determine the lateral diameter based on distribution lateral network design.
  - a. Lateral diameter typically ranges from 0.75 to 4 inches for most system applications.
  - b. Lateral diameter for typical individual dwelling systems range from 0.75 to 2 inches.
5. Lateral length should be selected based on the lateral diameter, orifice spacing, and piping schedule/class.

Lateral length is constrained by the minimum pressure at the distal end of the lateral, which shall not drop below 90% of the manifold pressure. This uniform pressure ensures relatively uniform effluent discharge down the length of the lateral.
6. Individual ball or gate valves shall be installed on each lateral to balance residual head on terraced systems.
7. Sweeping cleanouts should be placed at the terminal end of each lateral and accessible from grade.
  - a. Cleanout sweeps should be the same diameter piping as the main lateral.
  - b. A ball valve or threaded cap should be located on the end of the cleanout that allows the lateral to be flushed.
  - c. Prior to pressurization of the distribution laterals, the system should be flushed with clean water while all of the terminal ball valves are open or caps are removed.
  - d. Cleanout access risers shall not extend past the installation depth of the drainfield (i.e., drainrock or gravelless system component) and native soil or medium sand interface.

### *Orifices*

1. Orifice sizing, spacing, and quantity, coupled with each lateral's pressure, establish the flow rate of the distribution network.
2. Orifice placement should occur
  - a. Along the same axis of the distribution lateral.
  - b. In a staggered location between any two adjoining laterals so they are located half of the orifice spacing from one another along the drainfield length.

- c. Orifices should be placed to serve a circular area as best as possible with limited overlap (e.g., 6-foot wide trench with two laterals and orifice placement to serve an area 3 feet in diameter).
3. Orifice orientation
  - a. Is typically toward the bottom of the trench in aggregate-filled drainfields to facilitate lateral drainage and towards the top of the trench in gravelless trench component drainfields.
  - b. If the orifices in the distribution laterals are oriented up, the distribution lateral must slope back towards the manifold to aid in drainage. Sloping of the distribution lateral should be as minimal as possible. All manifold and distribution lateral drainage not drained to the drainfield shall drain back to the dosing chamber if not retained in the transport piping below frost levels.
4. Orifice diameter
  - a. Typical orifice diameter is 0.25 inch but may be smaller or larger depending upon system design requirements.
  - b. Orifices smaller than 0.25 inch may lead to clogging, which should be considered in system design.
  - c. Typical discharge rates based on orifice size are provided in Table 4-17
5. Orifice spacing should distribute effluent as evenly and uniformly as possible over the infiltrative surface.
  - a. Typical orifice spacing is 30–36 inches but may be closer or farther apart depending upon system design requirements, system flow rate, and soil type.
  - b. For most installations, the spacing will be between 18–36 inches.
  - c. The maximum orifice spacing for sand mounds, intermittent and in-trench sand filters, and recirculating gravel filters is 2.25 feet.
6. Orifices should be drilled with a sharp bit, and any burs, chips, or cuttings from the drilling process should be removed from the piping prior to assembly.
7. Orifice shields are recommended to be used when orifices are oriented up.

**Table 4-17. Orifice discharge rate in gallons per minute based on pressure.**

Pressure (feet)	Orifice Diameter (inches)				
	1/8	3/16	1/4	5/16	3/8
2.5	0.29	0.66	1.17	1.82	2.62
3.0	0.32	0.72	1.28	2.00	2.87
3.5	0.34	0.78	1.38	2.15	3.10
4.0	0.37	0.83	1.47	2.3	3.32
4.5	0.39	0.88	1.56	2.44	3.52
5.0	0.41	0.93	1.65	2.57	3.71
5.5	0.43	0.97	1.73	2.7	3.89
6.0	0.45	1.02	1.8	2.82	4.06
6.5	0.47	1.06	1.88	2.94	4.23
7.0	0.4	1.1	1.95	3.05	4.39
7.5	0.5	1.14	2.02	3.15	4.54
8.0	0.52	1.17	2.08	3.26	4.69
8.5	0.54	1.21	2.15	3.36	4.83
9.0	0.55	1.24	2.21	3.45	4.97
9.5	0.57	1.28	2.27	3.55	5.11
10.0	0.58	1.31	2.33	3.64	5.24

Notes: Values were calculated as:  $GPM = 11.79 \times d^2 \times h^{1/2}$ ; where d = orifice diameter in inches, h = head in feet.

### *Lateral Discharge Rate*

Once the numbers of laterals, lateral diameter, orifice spacing, and orifice diameter have been selected, the individual lateral discharge rate and total distribution system discharge rate can be calculated. Individual lateral discharge rate is calculated by the following:

$$GPM = (\text{individual orifice discharge rate}) \times (\text{number of orifices per lateral})$$

The total distribution system discharge rate is calculated by the following:

$$GPM = (\text{individual lateral discharge rate}) \times (\text{total number of laterals})$$

#### **4.19.3.1.1 Manifold Piping**

The manifold is typically a larger diameter pipe that provides a uniformly pressurized effluent to the distribution laterals. The manifold is at the terminal end of the transport piping. There are three common manifold designs:

- End manifold
- Central manifold
- Offset manifold

End manifolds are located at one end of the distribution laterals. Central manifolds are located at the midpoint of the distribution laterals. Offset manifolds may be located at any point along the distribution laterals. Multiple manifolds may also be used in a system design as long as the

pressures at each manifold are equal. The following design elements for manifolds are recommended:

1. The manifold pipe diameter must accommodate the number, spacing, and discharge rate of the distribution laterals.
2. It is recommended that the outlet to the laterals occur at the crown of the manifold to minimize leakage from the distribution laterals prior to their complete pressurization.
3. The manifold should drain to either the pump chamber or the distribution laterals when the pump shuts off.
4. If the manifold cannot drain, it should be insulated to protect it from freezing.

#### **4.19.3.1.2 Transport Piping**

The transport piping, or line, is the piping that connects the pump in the dosing chamber and manifold. The length and diameter of this piping varies based upon pump selection, wastewater flows, transportation distance, and elevation difference between the pump and drainfield. Several design recommendations should be followed for this section of piping:

1. The transport pipe exiting the dosing chamber should have a minimum strength equivalent meeting the specifications in Table 5-13.
2. Transport piping should be sloped to drain back into the dosing chamber when the pump shuts off. A small drain hole (0.25 inch) may be drilled in the transport pipe inside the dosing chamber to aid in the pipe draining. This drain hole must be taken into account in pressure distribution design and pump selection.
3. If the transport pipe cannot be sloped back to the dosing chamber, the piping should be buried below the site-specific frost line to prevent freezing.
4. Friction loss should be considered when selecting the diameter of the transport piping.
  - a. The material and diameter of the transport pipe will influence the friction loss.
  - b. The friction increases with increasing flow rates.
  - c. Friction losses must be included in the system performance curve to properly select a suitable pump.

#### **4.19.3.2 Pressurization Unit**

Pressurization of the piping network occurs through a pressurization unit, which may be an electrically driven pump or a gravity charged siphon. Electrically driven pumps may be used in any pressurized design regardless of the site layout. Siphons are limited to pressurized designs where all of the piping components are located below the siphon discharge invert. A critical component of either pump selection or siphon design is the total head the pressurization unit must operate against. Total head can be calculated using Equation 4-14.



$$H_{total} = E + T + R$$

**Equation 4-14. Total head.**

where:

$H_{total}$  = total head

E = elevation difference between the pump or siphon bell opening and manifold

T = piping network's friction head

R = residual head (2.5-10 feet)

#### 4.19.3.2.1 Pumps

Pumps used in the pressure distribution design are either centrifugal effluent pumps or turbine effluent pumps. Centrifugal pumps are typically a high capacity/low-head pump with a relatively flat performance curve. Turbine pumps are typically a low capacity/high-head pump with a relatively steep performance curve. The type of pump that is selected should be based on the point where the pump's performance curve intersects the system's performance curve. A pump is suitable for a particular system if the middle of its performance curve intersects the system performance curve at an acceptable pressure and flow value. Specific pump selection factors are discussed below:

1. Use the pump head discharge rate curves supplied by the manufacturer to select a pump that will perform at the required head.
2. To help maximize pump efficiency, pump selection should also address maximum usable head.
  - a. Select pumps where the operating point will be greater than 15% of the maximum discharge rate (maximum gallons per minute rating).
  - b. For example, a pump with a maximum discharge rate of 80 GPM should only be used if the operational requirement is greater than 80 GPM x 0.15 or 12 GPM.
3. Other pump considerations:
  - a. Pump should be specified for effluent.
  - b. Pump should transfer solids as large as orifice diameter.
  - c. Pumps must be kept submerged.
  - d. Pump should be serviceable from ground level without entering the pump chamber. PVC unions are available to assist in the easy removal of pumps.
  - e. Pumps and electrical connections shall conform to the requirements of the Idaho Division of Building Safety, Electrical Division.
    - 1) Electrical permits are required for installing all pumps, and the applicant, responsible contractor, and/or the responsible charge engineer are responsible for obtaining the proper electrical permits.
    - 2) Installation of all electrical connections is required to be performed by a licensed electrician. The applicant, responsible contractor, and/or the responsible charge engineer are responsible for ensuring that the installation is performed by a properly licensed individual.
    - 3) Subsurface sewage disposal installer registration permits are not equivalent to, or substitutes for, a proper electrical license.

- f. Impellers shall be cast iron, bronze, or other corrosion-resistant material. Regardless of the material, the impeller may freeze if the pump remains inactive for several months.
- g. If a check valve is used, a bleeder hole should be installed so the volute is kept filled with effluent. Some pumps may run backwards if the impeller is in air.
- h. Siphon (vacuum) breakers should be used in pressure distribution networks where the low water level in the dosing chamber is above the lateral inverts in the drainfield.

#### 4.19.3.2.2 Siphons

Siphons build up more head in the dosing chamber than the distribution piping network requires to operate correctly. The siphon flow rate must be greater than the discharge rate out of the distribution lateral orifices. Siphons only work in a demand dosing situation. Recommendations for siphon dosing systems are included below:

1. Frequent maintenance checks should be performed on siphons to ensure they are operating properly and are not distributing effluent under *trickling* conditions.
2. High water audio and visual alarms should be placed in siphon dosing chambers above the operating point of the siphon and below the siphon vent.
3. Siphons must discharge to a piping network that allows steady flow. Piping networks that have abrupt bends or tees will create pressure oscillations that will disrupt the siphon flow, resulting in *trickling* flows.
4. Siphon trap diameter must be smaller than the piping network's transport pipe.
5. The dosing chamber must provide an overflow tee in case the siphon becomes plugged. This tee also allows gas in the drainfield to escape into the dosing chamber as the effluent displaces it.

#### 4.19.3.3 Dosing

Dosing consists of the type of dosing that is selected for the system design and dosing volume (dose). Two types of dosing are available for system pressurization: demand dosing and timed dosing. These dosing parameters are discussed below.

##### 4.19.3.3.1 Demand Dosing

Demand dosing can be performed using both electrically driven pumps and gravity driven siphons. In demand dosing, a specific volume of effluent is sent to the drainfield with each dose based on the specific system demand. This demand is triggered by the volume of effluent reaching a predetermined level within the dosing chamber. Once this level is reached, the entire predetermined volume of effluent is delivered to the drainfield. After a pumping cycle effluent will not be delivered to the drainfield until enough effluent has entered the dosing chamber to reach the predetermined pump-on level. This type of dosing leaves little control over how much effluent is delivered to the drainfield during high flow events.

##### 4.19.3.3.2 Timed Dosing

Timed dosing can only be performed through the use of an electrically driven pump. Due to the more frequent start/stop cycling of the pump in timed dosing, a pump with good longevity is

recommended. Turbine pumps are typically a good fit for this design based on their longevity relative to start/stop cycles. Timed dosing uses a timer to deliver effluent to the drainfield on a regularly timed schedule. Scheduling is done by setting an amount of time the pump is off between cycles and the amount of time the pump is on during the cycle. Advantages of this dosing method are listed below:

- Smaller and more frequent doses can be delivered to the drainfield.
- Peak and surge flows can be leveled out so the drainfield is not overloaded.
- A higher level of treatment is provided to the effluent at the infiltrative surface.
- Greater drainfield longevity.

With timed dosing, surge capacity should be taken into account when sizing the dosing chamber. The chamber should be large enough to handle peak and surge flows. A high-level override switch may be used below the high-level alarm to override the pump timer when large flows enter the dosing chamber. Controls can also be put in place to ensure that only full doses will be delivered to the drainfield preventing pump cycles that will not result in effluent reaching the drainfield.

#### 4.19.3.3.3 Dose

The dose is the volume of effluent necessary to fill the entire pressurized piping network and the volume of effluent that is desired to be delivered to the infiltrative surface with each dose. The dose volume is based on the volume of the transport and distribution piping network and the frequency at which the drainfield is desired to be dosed throughout any given day. Dose volume is determined by the following sets of design criteria:

1. Determine the volume of all piping components including the transport piping, manifold, and distribution laterals. Only pipe volumes that drain between doses should be used in dosage calculations. Table 4-18 can be used to calculate distribution line, manifold, and transport line volumes.

**Table 4-18. Gallons per foot of pipe length.**

Diameter (inches)	Schedule 40	Class 200	Class 160	Class 125
1	0.045	0.058	0.058	—
1.25	0.078	0.092	0.096	0.098
1.5	0.105	0.120	0.125	0.130
2	0.175	0.189	0.196	0.204
3	0.385	0.417	0.417	0.435
4	0.667	0.667	0.714	0.714
6	1.429	1.429	1.429	1.667

2. Determine the dose volume delivered to the infiltrative surface by dividing the system design flow, in gallons per day.
3. The daily dose-volume ratio should be five to ten times the volume of the manifold and distribution lateral piping that drains between doses plus one time for the interior volume of the transport line.

4. Each dose delivered to the infiltrative surface of the drainfield should not exceed 20% of the estimated average daily wastewater flow. If the total dose volume is too small, then the pipe network will not become fully pressurized or may not be pressurized for a significant portion of the total dosing cycle and may need to be adjusted.

#### **4.19.3.4 Dosing Chamber**

Dosing chambers are tanks that contain a pump or siphon and their associated equipment. The dosing chamber is either a separate septic tank located after the septic tank or may be the last compartment of a multicompartment septic tank. If the dosing chamber is part of a multicompartment septic tank, it must be hydraulically isolated from the compartment(s) of the tank that comprise the septic tank portion of the tank. The construction of a dosing chamber shall meet the requirements of IDAPA 58.01.03.007 except as specified herein. Figure 4-20 provides a dosing chamber diagram with a pump and screen, and Figure 4-21 provides a dosing chamber diagram with a pump vault unit.

1. Dosing chambers must be listed on the approved list of dosing chambers (section 5.3), or must be listed on the approved list of septic tanks (section 5.2).
2. Pump vaults and effluent filters must be listed on the approved list of pump vaults (section 5.7) or must be listed on the approved list of septic tank effluent filters (section 5.8).
3. Any system using a pump located after the septic tank to deliver effluent to the drainfield (pressurized or nonpressurized) or a nonpackaged alternative pretreatment component shall locate the pump in a dosing chamber meeting the minimum requirements herein.
4. Dosing chamber must be watertight, with all joints sealed. Precautions must be made in high ground water areas to prevent the tank from floating.
5. Effluent must be screened or filtered prior to the pump.
  - a. A screen constructed of noncorrosive material must be installed to protect the pump with a minimum of 1/8-inch or slits and have a minimum screening flow area of 4 ft<sup>2</sup> for non-engineered applications
  - b. Screen placement must not interfere with the floats and should be easily removable for cleaning.
  - c. An effluent screen or filter placed in the septic tank may be used as a suitable alternative to pump screens and must be constructed with 1/8-inch or smaller holes or slits of noncorrosive material and include a flow area appropriate to provide a rated mean-time between screen cleanings of 4 years or more based on system design flow, or have a screening flow area of at least 1 ft<sup>2</sup> in non-engineered systems unless the filter has a close-off feature that prevents effluent from being discharged to the drainfield when the filter is removed. If placed in the septic tank, a riser to finish grade is needed to provide easy access for cleaning. All screens must be installed according to manufacturer's recommendations.
  - d. The filter flow area for engineered systems should meet screen cleaning interval outlined in the system O&M manual.
  - e. Any effluent filter used in a septic tank in place of conventional outlet piping, shall conform to the liquid draw requirements listed under IDAPA 58.01.03.007.11.d,

- which is 40% of tank liquid volume in vertical-walled tanks and 35% on horizontal cylindrical tanks.
6. The volume of the dosing chamber should be equal to at least two times the system design flow when a single pump is used.
    - a. If duplex pumps are used, the volume of the dosing chamber may be reduced to equal the system design flow. The dosing chamber must come from the approved septic tank or dosing chamber list.
    - b. The volume of the dosing chamber must be sufficient enough to keep the pump covered with effluent, deliver an adequate dose based on the system design, and store 1 day of design flow above the high-level alarm.
    - c. Additional dosing chamber capacity may be necessary if the pressurized system is designed to have surge capacity.
  7. The dosing chamber manhole located above the pump shall be brought to grade using a rise. Access to the pumps, controls, and screen is necessary.
  8. A high-level audio and visual alarm float switch shall be located within the dosing chamber 2–3 inches above the pump-on level to indicate when the level of effluent in the dosing chamber is higher than the height of the volume of one dose.
  9. A low-level shutoff float switch shall be connected to the pump and be set to a height that is 2–3 inches above the top of the pump. This ensures the pump remains submerged.
  10. If a differential control float is used to turn the pump on and off, care must be exercised to ensure the float will effectively deal with the required dose based on the inches of drop in the dosing chamber.
  11. Dosing chamber electrical requirements:
    - a. All electrical system designs and installations must be approved by the Idaho Division of Building Safety, Electrical Division.
    - b. Electrical permits are required for installing all electrical components and the applicant, responsible contractor, and/or the responsible charge engineer are responsible for obtaining the proper electrical permits.
    - c. Installation of all electrical connections is required to be performed by a licensed electrician. The applicant, responsible contractor, and/or the responsible charge engineer are responsible for ensuring that the installation is performed by a properly licensed individual.
    - d. Subsurface sewage disposal installer registration permits are not a substitute for an electrical installer license.
    - e. Visual and audible alarms should be connected to a separate circuit from the pump. It is recommended that a DC battery backup power source be considered for the visual and audible alarm.

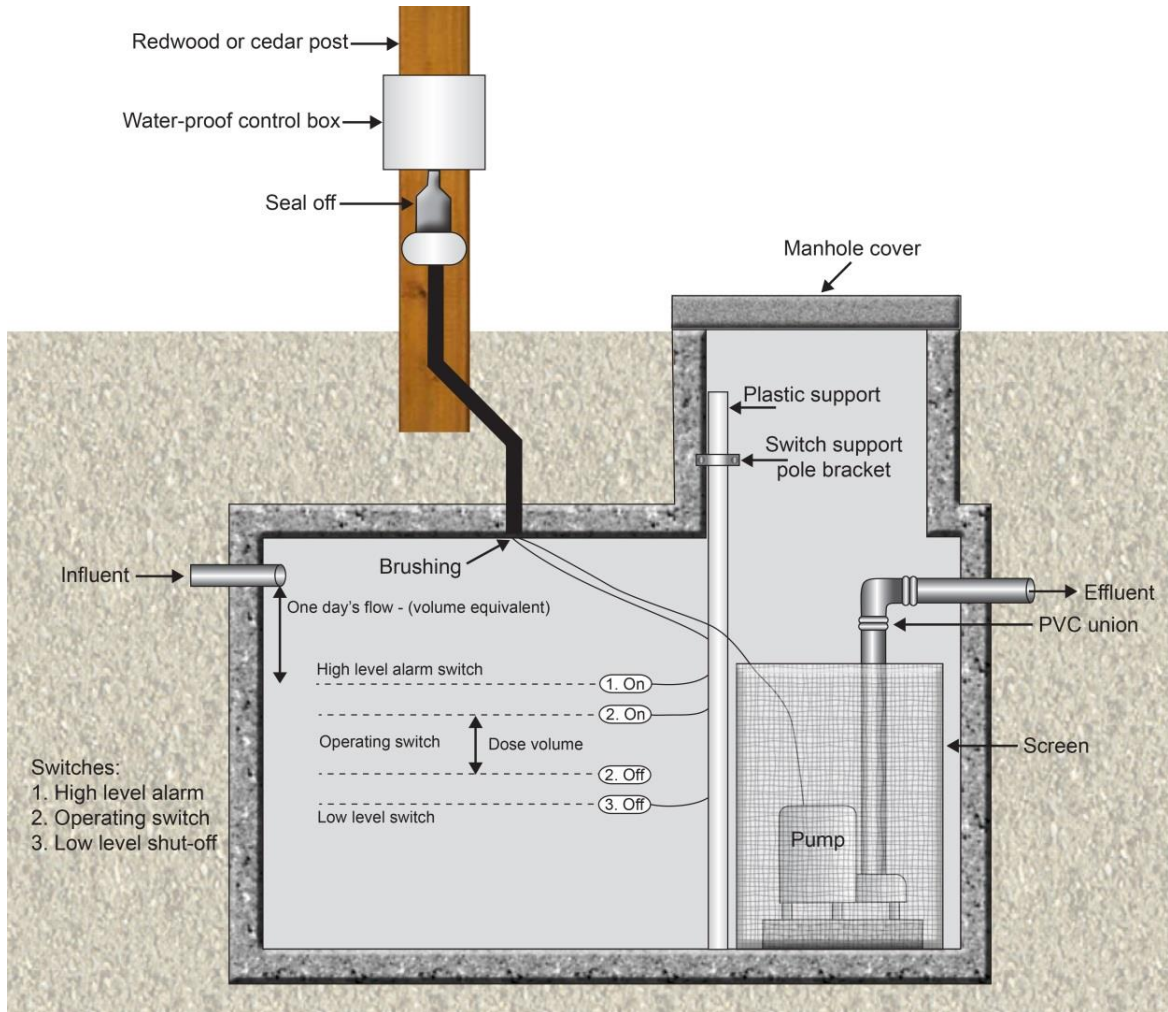
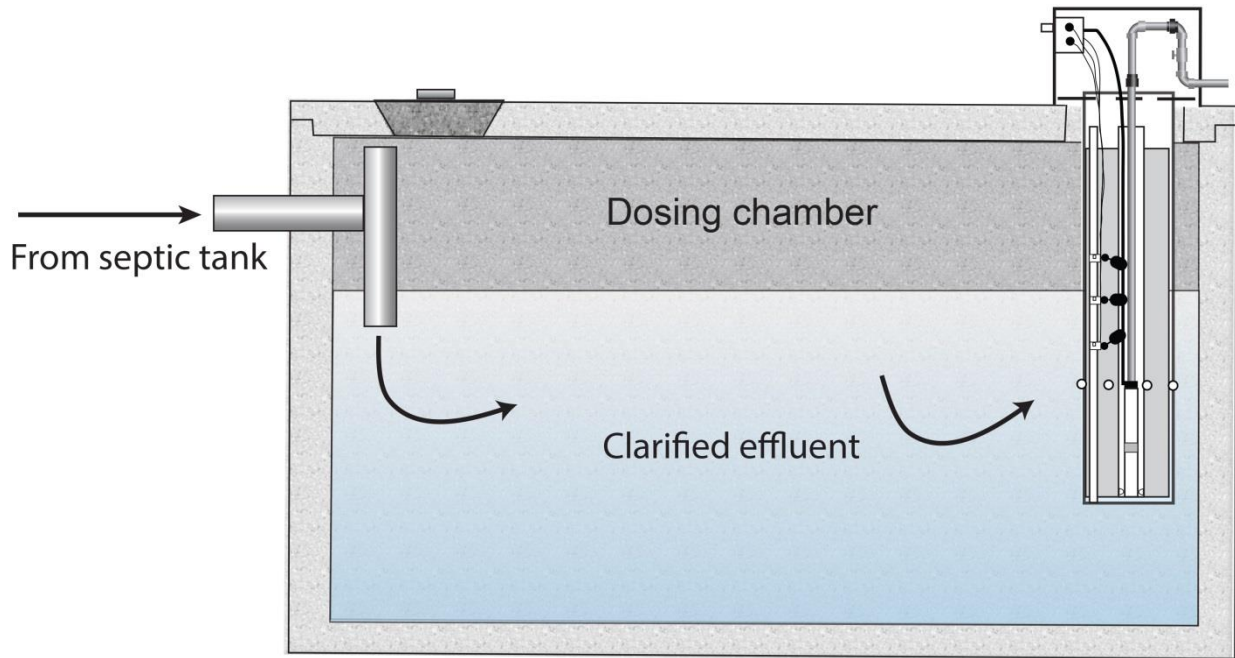

Figure 4-20. Dosing chamber with a pump and screen.

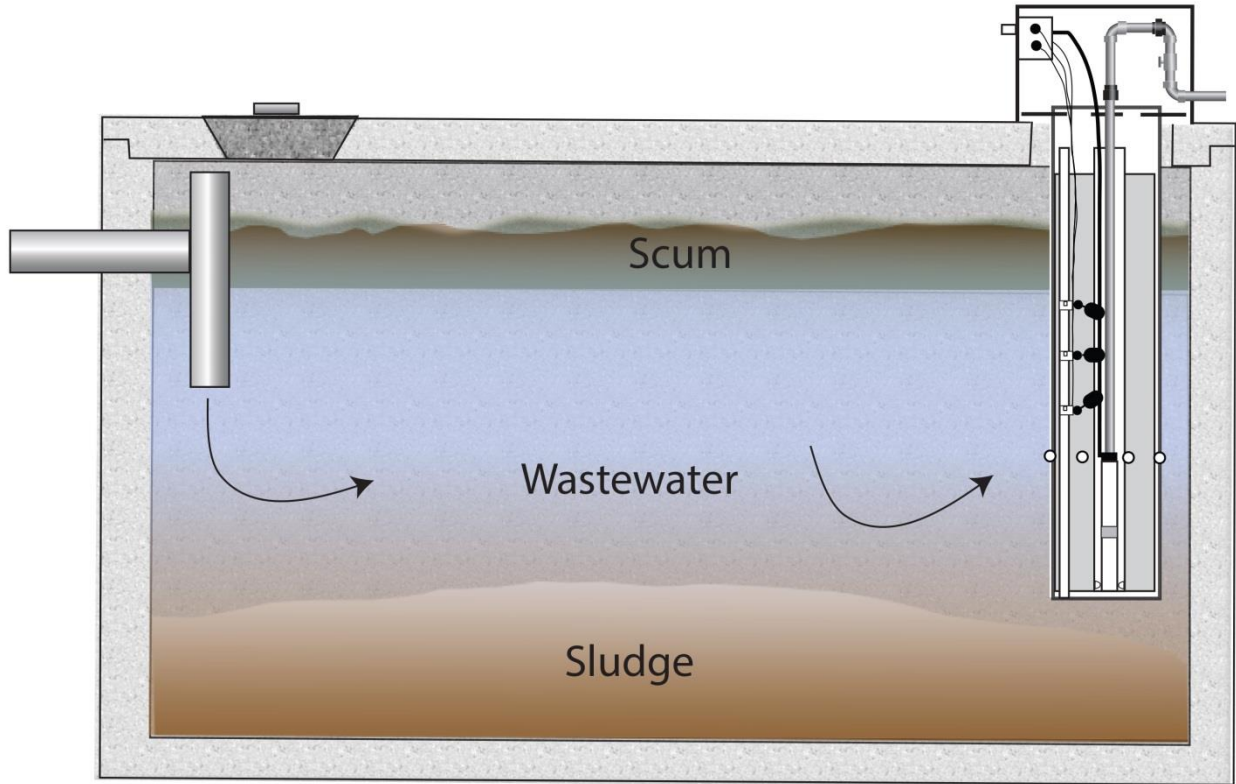

**Figure 4-21. Dosing chamber with a pump vault unit.**

#### **4.19.3.5 In-Tank Pumps**

Placement of sewage effluent pumps in a septic tank is an acceptable practice under the following conditions:

1. The site is too small for the installation of a dosing chamber or a septic tank with a segregated dosing chamber compartment, or the flows are less than 100 GPD.
2. Sewage effluent pumps must be placed in an approved pump vault (section 5.7).
3. Effluent drawdown from the septic tank is limited to a maximum 120 gallons per dose with a maximum pump rate of 30 GPM.
4. Septic tanks must be sized to allow for 1-day flow above the high-water alarm, unless a duplex pump is used.
5. Pump vault inlets must be set at 50% of the liquid volume.
6. Pump vault placement inside the septic tank shall be in accordance with the manufacturer's recommendations.
7. Pump vault screens shall be 1/8-inch holes, or slits (or smaller); constructed of noncorrosive material; and have a minimum area of 12 ft<sup>2</sup>.
8. Pump vault and pump placement must not interfere with the floats or alarm, and the pump vault should be easy to remove for cleaning (Figure 4-22).
9. The same electrical requirements that apply to both pumps and dosing chambers apply to in-tank pumps.



**Figure 4-22. Example of effluent pump installed into single-compartment septic tank using a pump vault unit.**

#### **4.19.3.6 Pump to Gravity Distribution**

A pump to drop box system may be used when an area for drainfield placement cannot be reached by standard gravity flow from the wastewater generating structure. Standard drainfields located at higher elevations than the septic tank are not required to be designed as a pressure distribution system unless the square footage of the disposal area exceeds 1,500 ft<sup>2</sup>. When the drainfield is not pressurized, wastewater is conveyed by a pump through a transport (pressure) line to a drop box where effluent pressurization breaks to gravity distribution into the drainfield (Figure 4-23). For a description of a drop box, see section 3.2.6.2. Distribution boxes may be substituted as a drop box for the purpose of a pump to gravity distribution system. Alternating to larger diameter pipe to break pressurization and achieve gravity flow should not be used as a substitute for a drop box.

1. Pump selection, transport (pressure) line design, dosage, and dosing chamber or in-tank pump design shall follow the procedures in Section 4.19, "Pressure Distribution System."
2. A drop box should be installed that allows gravity distribution to all drainfield trenches.
3. Upon entry into the drop box, the effluent line should be angled to the bottom of the box with the effluent line terminating above the high water level of the drop box.  
A 0.25-inch hole may need to be drilled in the top of the angle connection to prevent a potential siphon.
4. A complex installer's permit shall be required for installation.



5. Pump and transport pipe design/selection may require engineering based upon the regulatory authority’s judgment. Pump design/selection should be performed by a PE licensed in Idaho when elevation gains of greater than 100 feet or lengths of 500 feet are exceeded in effluent transport.

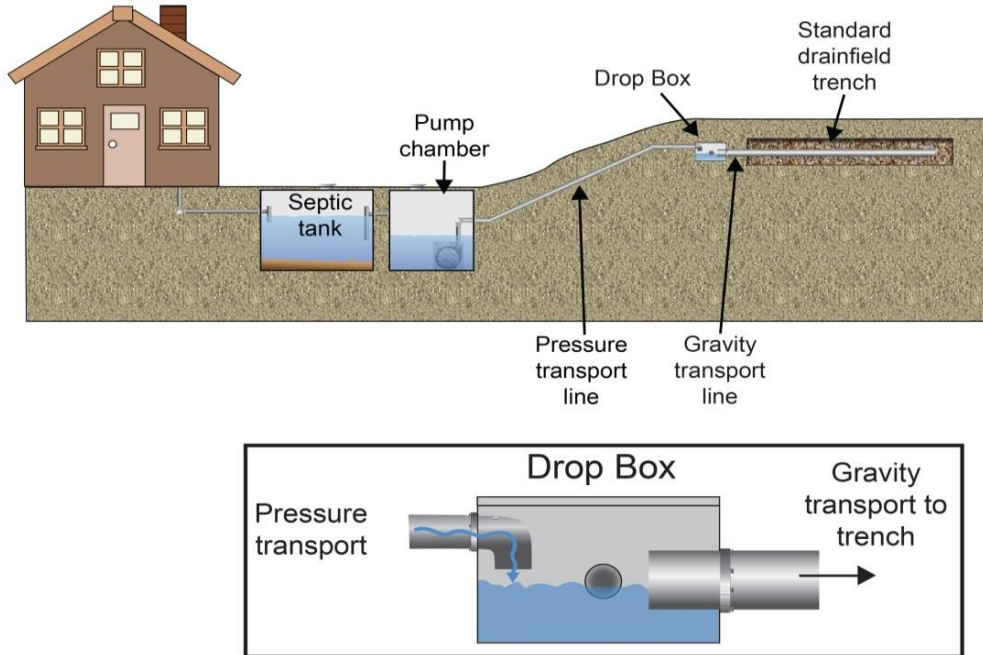

Figure 4-23. Example of pump to drop box installation.

#### 4.19.4 Inspections

1. Site inspections shall be conducted by the health district at the following minimum intervals (IDAPA 58.01.03.011.01):
  - a. Preconstruction conference that should be conducted with the health district, responsible charge engineer (except for the pump to gravity distribution system designs that do not require engineering), complex installer, and property owner (if available) present.
  - b. During construction as needed.
  - c. Final construction inspection that includes a pump drawdown/alarm check and pressure test of the distribution network.
2. The responsible charge engineer (except for the pump to gravity distribution system designs that do not require engineering) shall provide the health district with a written statement that the system was constructed and functions in compliance with the approved plans and specifications. Additionally, the responsible charge engineer shall provide as-built plans to the health district if any construction deviations occur from the permitted construction plans. (IDAPA 58.01.03.005.15).

#### 4.19.5 Operation and Maintenance

An O&M manual shall be developed by the system's design engineer that contains the following minimum requirements and shall be submitted as part of the permit application (IDAPA 58.01.03.005.14).

1. Operation and maintenance is the responsibility of the system owner.
2. Sludge depth in the septic tank should be checked annually and the tank should be pumped when the sludge exceeds 40% of the liquid depth.
3. All pump and pump chamber alarm floats and controls should be inspected on a regular schedule to ensure proper function.
4. Drainfield laterals should be flushed annually to ensure any biomat buildup is removed from the distribution lateral. Lateral flushing procedures should be described.
5. The system's residual head should be tested at the distal end of the drainfield annually after lateral flushing. Residual head testing procedures should be described.
6. Pump screens and effluent filters should be inspected regularly and cleaned. All material created from cleaning the screen or filter should be discharged into the septic tank.
7. All manufactured components of the pressure distribution system should be maintained according to the manufacturer's recommendations.
8. Any other operation and maintenance as recommended by the system design engineer.

## 4.20 Recreational Vehicle Dump Station

Revision: April 19, 2013

Installer registration permit: Property owner or standard and basic

Licensed professional engineer required: No

### 4.20.1 Description

Recreational vehicle (RV) dump stations are sealed septic tanks for the disposal of RV-generated wastewater. RV dump stations pose a unique problem for subsurface sewage disposal systems because the recirculating fluid used in RV tanks contains formaldehyde and/or paraformaldehyde. The presence of these chemicals inhibits bacterial action inside of a septic tank, which leads to solids carry over and premature failure of the drainfield. Compounding the problem is that RV units recirculate the fluid several times before it is dumped. The fluid disposed in the dump station then is both *strong* and preserved. Because of these issues with RV-generated wastewater, RV dump stations should not be connected to subsurface sewage disposal systems.

### 4.20.2 Approval Conditions

1. A management entity or arrangement to provide maintenance and pumping of the dump station tank by a permitted septic tank pumper should be provided prior to permit issuance.
2. An RV dump station tank shall not have wastewater conveyed to it through a collection system.
3. RV wastewater shall be discharged into the dump station vault directly from the RV's wastewater storage tanks.
4. If the RV dump station tank is a modified septic tank, the inlet and outlet openings shall be sealed.
5. RV dump stations may not be located in a floodway.
6. The RV dump station tank lid shall be sloped to the dump point and have a wastewater spill containment rim.
7. A source for dump station wash-down water shall be provided to the RV dump station location.
8. The water source shall meet the same separation distances from the RV dump station tank as required by IDAPA 58.01.03.007.17.

### 4.20.3 Requirements

1. The RV dump station tank must meet the distance limitations of a septic tank (IDAPA 58.01.03.007.17).
2. The RV dump station tank must meet the septic tank design and construction standards as described in IDAPA 58.01.03.007. Requirements of IDAPA 58.01.03.007.07, 58.01.03.007.08, 58.01.03.007.09-10, 58.01.03.007.19, and 58.01.03.007.22 are exempt.
3. If the RV dump station tank is a modified septic tank, the inlet and outlet opening shall be sealed

4. A manhole extension shall be brought to finished grade that allows pumping access to the RV dump station tank.
5. An emergency warning system shall be required to be installed to indicate when the RV dump station tank is two-thirds full.
6. The RV dump station tank shall meet the volume requirements of a septic tank, except that no RV dump station tank shall be less than 1,500 gallons.
7. Any permit issued for a subsurface sewage disposal system serving RV spaces should include a requirement to install an RV dump station tank that allows RVs to discharge their preserved waste prior to discharging of waste to the subsurface sewage disposal system.

#### **4.20.4 Recreational Vehicle Dump Station Waste Disposal**

1. RV dump station tank waste shall be pumped and removed by a permitted septic tank pumper.
2. Wastewater from an RV dump may be disposed of at the following locations:
  - a. Municipal treatment plant
  - b. Approved septage land application site
  - c. Approved discharge to public sewer

## 4.21 Recirculating Gravel Filter

Revision: May 18, 2016

Installer registration permit: Complex

Licensed professional engineer required: Yes

### 4.21.1 Description

A recirculating gravel filter is a bed of filter media in a container that filters and biologically treats septic tank effluent. The filter effluent is returned to the recirculation tank for blending with untreated septic tank effluent and recirculated back to the filter. The treated effluent is distributed to a disposal trench of reduced dimension. The effluent returned from the filter may either return to the recirculation tank or a combination of the equalization tank and recirculating tank depending on effluent treatment requirements. Minimum system components include, but are not limited to, the following:

1. Septic tank
2. Equalization tank (if nitrogen reduction is required)
3. Recirculation tank
4. Low-pressure distribution system
5. Free-access filters
6. Flow splitter
7. Dosing chamber (if drainfield is pressurized)
8. Drainfield

### 4.21.2 Approval Conditions

1. Nondomestic wastewater must be pretreated to normal domestic wastewater strengths (section 3.2.1, Table 3-1) before discharge to the recirculating gravel filter system.
2. The bottom of the filter must not come within 12 inches of seasonal high ground water.
3. All pressurized distribution components and design elements of the recirculating gravel filter system that are not specified within section 4.21 must be designed and installed according to the guidance for pressure distribution systems in section 4.19.
4. All tanks and the recirculating gravel filter container shall meet the same separation distance requirements as a septic tank.
5. Recirculating gravel filters required to reduce total nitrogen shall meet the additional design requirements in section 4.21.3.4.
6. System must be designed by a PE licensed in Idaho.
7. Recirculating gravel filters required to reduce total nitrogen to 27 mg/L shall follow the operation and maintenance requirements outlined in sections 1.9.1 and 1.9.3, effective July 1, 2017.
  - a. Operation and maintenance must be performed, as described in section 1.9.1, by a permitted complex installer that maintains a current service provider certification.
  - b. All subsurface sewage disposal permits issued for recirculating gravel filters meeting the above requirements shall contain the following statement beginning July 1, 2017:  
*Annual treatment system equipment servicing and reporting is required per IDAPA*

- 58.01.03.005.14. Operation and maintenance must be conducted by a complex installer maintaining a current service provider certification.*
- c. See sections 1.9.1 and 1.9.3 for compliance-related information for recirculating gravel filter operation, maintenance, and reporting.

### **4.21.3 Design Requirements**

Minimum design requirements for the recirculating gravel filter components are provided below.

#### **4.21.3.1 Recirculating Tank**

1. Minimum recirculating tank volume shall be capable of maintaining two times the daily design flow of the system (Figure 4-24).
2. The recirculating tank may be a modified septic tank or dosing chamber selected from section 5.2 or section 5.3.
  - a. Alternatively, the recirculation tank may be designed by the system's design engineer to meet the minimum requirements of this section and IDAPA 58.01.03.007.
  - b. Recirculating tank design is exempt from subsections .07, .08, .10, and .11 of IDAPA 58.01.03.007.
3. The recirculating tank shall be accessible from grade and the return line, pump, pump screen, and pump components shall be accessible from these access points.
4. The recirculating filter effluent return point shall be located before the recirculation tank and shall enter at the inlet of the recirculating tank, unless a gravity float valve is used in which case the return point shall be located near the inlet.
5. The recirculating tank shall meet all other minimum design and equipment requirements of section 4.19.3.4.

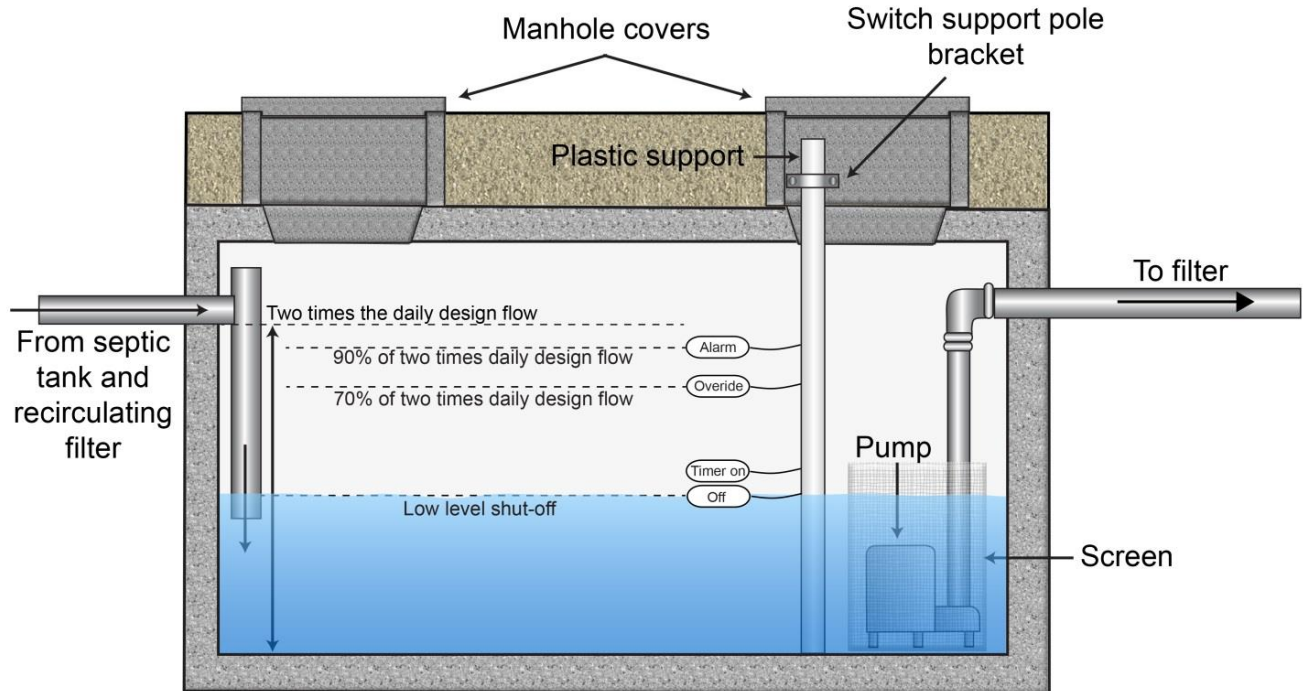

Figure 4-24. Recirculating tank in system design without nitrogen treatment requirements.

#### 4.21.3.2 Recirculating Filter

1. The filter container shall be constructed of reinforced concrete or other materials where equivalent function, workmanship, watertightness, and at least a 20-year service life can be documented.
2. The following requirements must be met for flexible membrane liners when used in place of concrete:
  - a. Have properties equivalent to or greater than 30-mil PVC.
  - b. Have field repair instructions and materials provided to the purchaser of the liner.
  - c. Have factory fabricated *boots* for waterproof field bonding of piping to the liner.
  - d. Liner must be placed against smooth, regular surfaces free of sharp edges, nails, wire, splinters, or other objects that may puncture the liner. A 4-inch layer of clean sand should provide liner protection.
3. The filter surface area is sized at a maximum of 5 gallons/ft<sup>2</sup>/day forward flow (forward flow is equivalent to the daily design flow from the structure).
4. Filter construction media shall meet the specifications in section 3.2.8.1.3 for pea gravel and section 3.2.8.1.1 for drainrock.
5. Minimum filter construction specifications (i.e., media depth, geotextile fabric placement, cover slopes, filter container height, and piping placement) shall meet the dimensions and locations depicted in Figure 4-25.
6. The bottom of the filter may be sloped at least 1% to the underdrain pipe.
7. An underdrain must be located at the bottom of the filter to return filtered effluent to the dosing chamber meeting the following requirements:

- a. May be placed directly on the bottom of the filter.
  - b. Placed level throughout the bottom of the filter.
  - c. Constructed of slotted drain pipe with 0.25-inch slots, 2.5 inches deep and spaced 4 inches apart located vertically on the pipe, or perforated sewer pipe with holes located at 5 and 7 o'clock.
  - d. One underdrain should be installed for each filter cell zone.
  - e. The distal end is vented to the atmosphere, protected with a screen, and located within the filter to allow entry of air flow into the bottom of the filter and access for cleaning and ponding observation.
  - f. Connected to solid pipe that meets the construction requirements of IDAPA 58.01.03.007.21, extends through the filter, and is sealed so the joint between the filter wall and pipe is watertight.
8. Two observation tubes should be placed in the recirculating filter to monitor for ponding and clogging formation.
    - a. The monitoring tubes must be secured and perforated near the bottom.
    - b. The monitoring tubes must extend through the recirculating filter cover and have a removable cap.
  9. The surface of the recirculating filter must be left open to facilitate oxygenation of the filter. No soil cover shall be placed above the upper layer of drainrock in the recirculating gravel filter. However, the filter must be designed to prevent accidental contact with effluent from the surface. The following minimum requirements must be followed:
    - a. Chain-link fence or another acceptable protective barrier (Figure 4-25) shall be placed at the top of the filter container and cover the entire surface of the filter to prevent access, unless fencing is placed around the entire system to prevent access.
    - b. Geotextile fabric shall be placed over the access barrier.
    - c. Fencing around the recirculating gravel filter is recommended for all central systems.



## Recirculating Gravel Filter

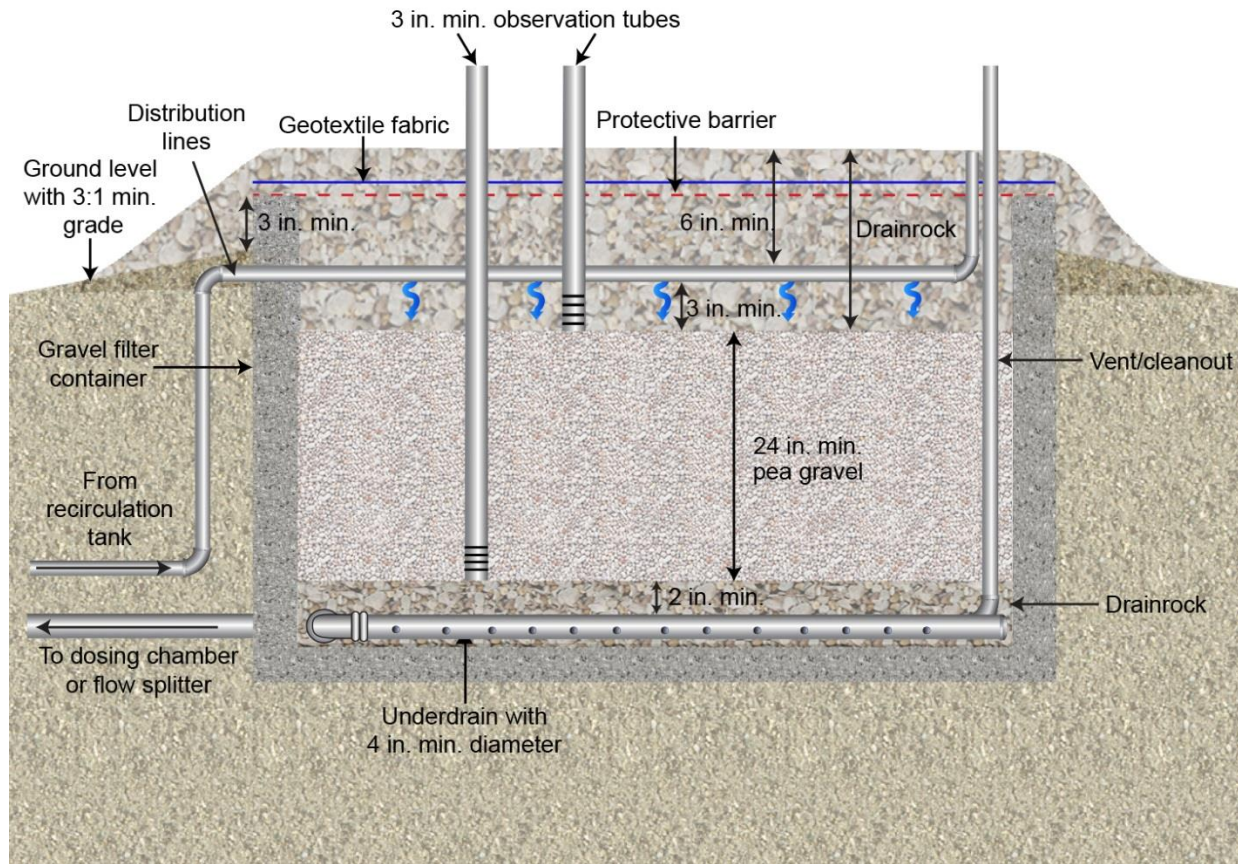

Figure 4-25. Recirculating gravel filter.

### 4.21.3.2.1 Recirculating Filter Cells

Depending on the volume of effluent and type of structure using a recirculating gravel filter, the recirculating filter may need to be split into cells that contain dosing zones (Figure 4-26). A filter cell is the total filter area that can be served by a single dosing pump or set of pumps. A filter zone is the area of a cell that can be dosed by a single dosing pump at any one time. Zone sizing depends upon pump size, lateral length, perforation size, and perforation spacing. The minimum filter design requirements for cells, zones, and pumps include the following:

1. Single-family homes: one cell, one zone, and one pump. If more than one cell or zone is used for a single-family home, duplex pumps are not required.
2. Central systems or systems connected to anything other than a single-family home (flows up to 2,500 GPD): one cell, two zones, and one pump per zone.
3. Large soil absorption systems (flows of 2,500 to 5,000 GPD): one cell, three zones, and one pump per zone.
4. Large soil absorption systems (flows over 5,000 GPD): two cells, two zones per cell, and one pump per zone.

5. An alternative to installing one pump per zone is to install duplex pumps connected to sequencing valves that alternate zones for each pressurization cycle. For systems with multiple cells, each cell must have a dedicated set of duplex pumps. Pumps should alternate between each cycle.
6. Filter cells are recommended to be hydraulically isolated from one another and shall be constructed according to the minimum requirements in section 4.21.3.2.
7. Each cell shall be equivalent in surface area and volume and have the same number of zones.
8. Each zone shall have the same number of laterals and perforations.

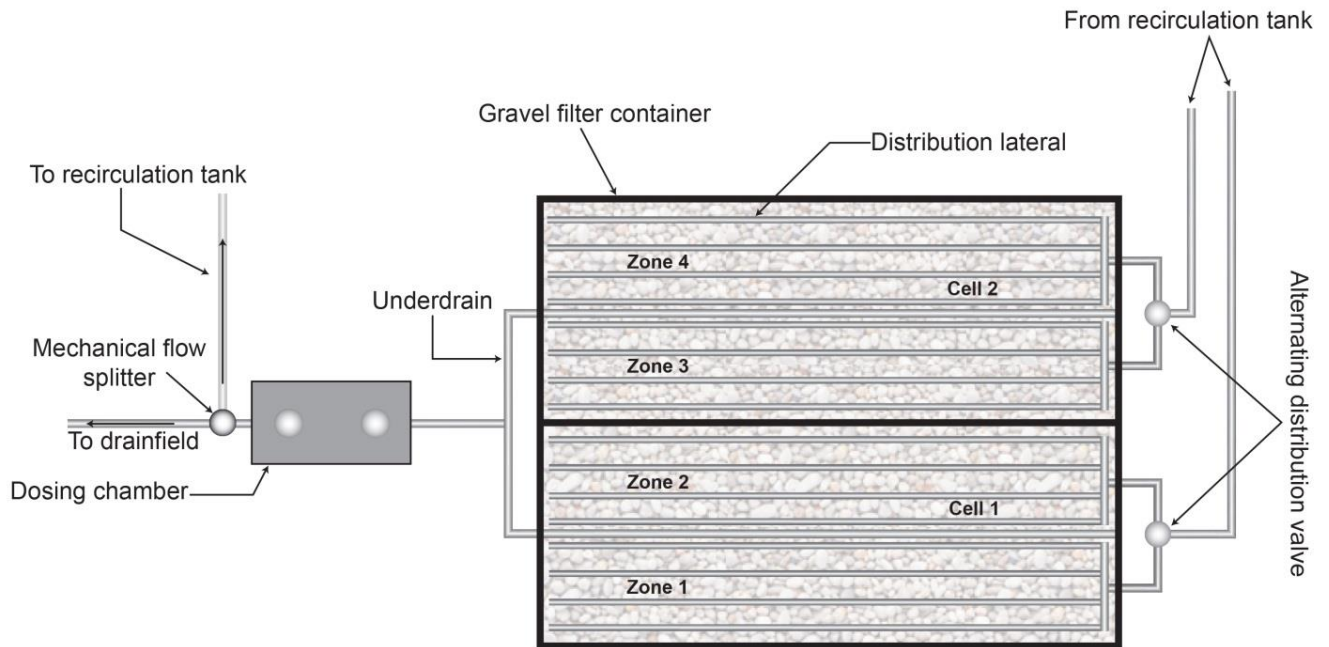

**Figure 4-26. Overhead view of a recirculating gravel filter with multiple cells and dosing zones discharging to a dosing chamber and using mechanical flow splitting.**

#### 4.21.3.2.2 Recirculating Filter Dosing

1. The minimum recirculation ratio of the filter is 5:1, and the maximum recirculation ratio is 7:1 (the daily flow moves through the filter a minimum of five times or a maximum of seven times before discharge to the drainfield).
2. Timed dosing is required, and the filter dosing cycle should meet the following minimum recommendations:
  - a. Pumps are set to dose each zone approximately two times per hour.
  - b. Dose volume delivered to the filter surface for each cycle should be 10.4% of the daily flow from the structure (forward flow).
  - c. A pump-on override float should be set at a point that equates to 70% of the recirculating tank's volume.
  - d. A low-level off float should be placed to ensure that the pump remains fully submerged at all times.

3. The pump controls should meet the following:
  - a. Be capable of monitoring low- and high-level events so that timer settings can be adjusted accordingly.
  - b. Have event counters and run-time meters to monitor daily flows.

#### **4.21.3.3 Effluent Return**

1. Effluent must be returned from the filter to the recirculation tank, which may occur by gravity or under pressure.
2. Gravity return must occur using a float valve (Figure 4-27) within the recirculating tank, and the float valve must:
  - a. Be located on the inlet side of the recirculating tank.
  - b. Allow for continual splitting of filtered effluent when the buoy is fully seated and discharging to the drainfield.
  - c. Be capable of returning 83% of the filtered effluent to the recirculation tank when the buoy is fully seated.
3. Other types of gravity flow splitters shall not be used to split recirculation flows.
4. Pressurized return must be done using a dosing chamber that meets the minimum requirements of section 4.19.3.4, and the dosing chamber must:
  - a. Be located after the recirculating filter.
  - b. Use a mechanical flow splitter (Figure 4-28 and Figure 4-29) that is capable of simultaneously returning effluent to the recirculating tank and discharging effluent to the drainfield.
5. Mechanical flow splitters shall:
  - c. Be located outside of the dosing chamber and prior to the recirculation tank.
  - b. Be capable of returning effluent to the recirculating tank and discharging to the drainfield in a volume ratio equivalent to the designed recirculation ratio (e.g., if a recirculation ratio of 5:1 is used, 83% of the filtered effluent by volume shall be returned to the recirculating tank, and 17% shall be discharged to the drainfield (Figure 4-30 and Figure 4-31).
6. Discharge of effluent to the drainfield must occur after filtration and flow splitting.

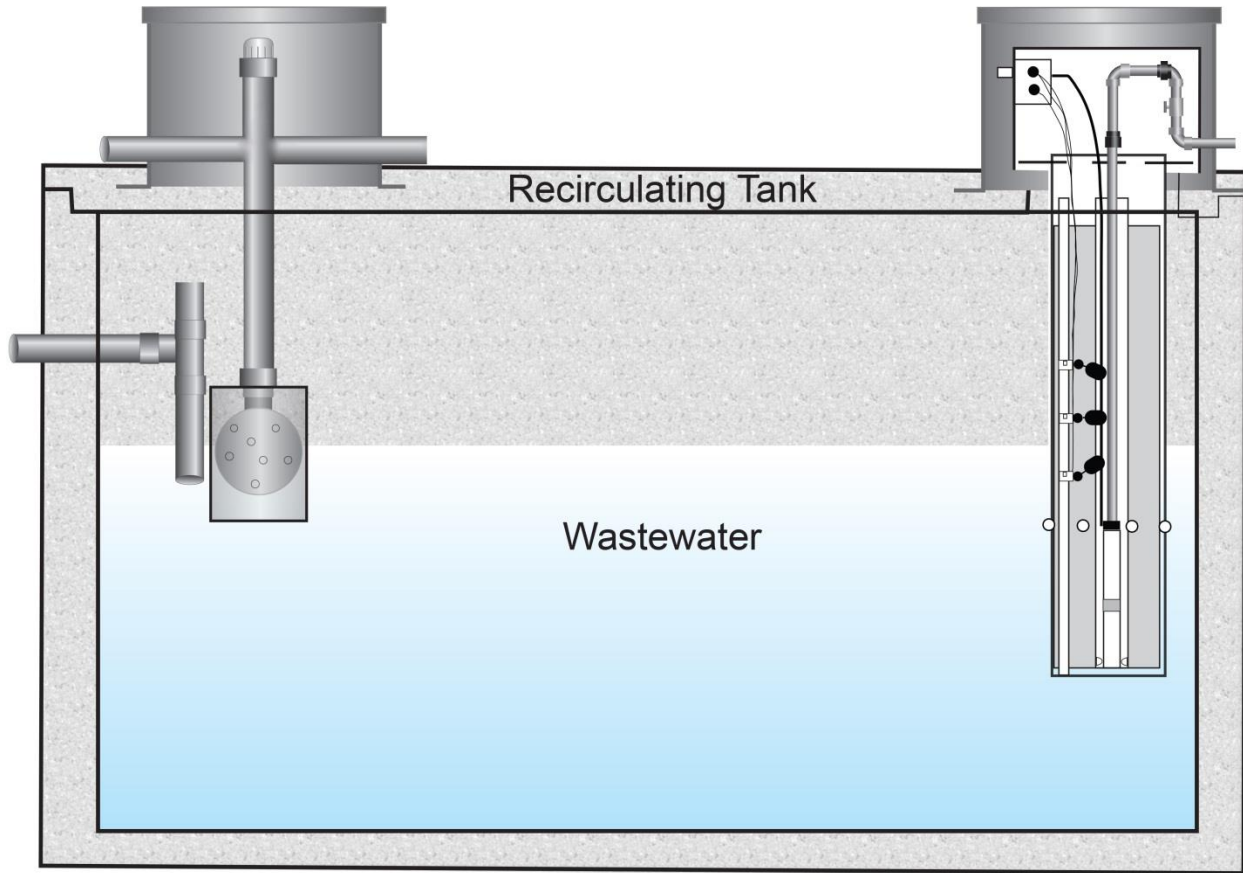

Figure 4-27. Gravity float valve return location within the recirculating tank.

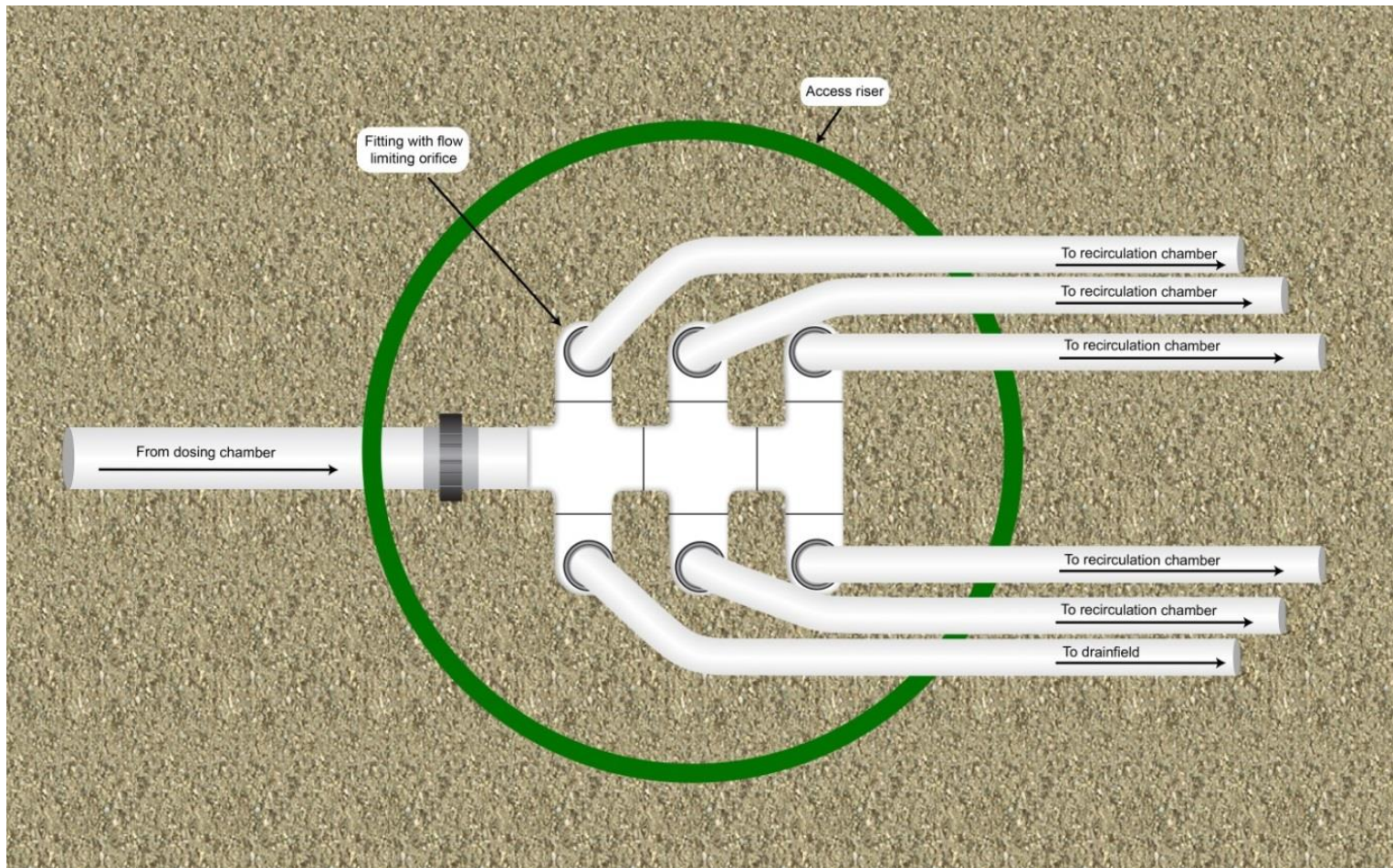

Figure 4-28. Bottom view of a mechanical flow splitter for gravity distribution that delivers wastewater to all transport pipes with each dose.

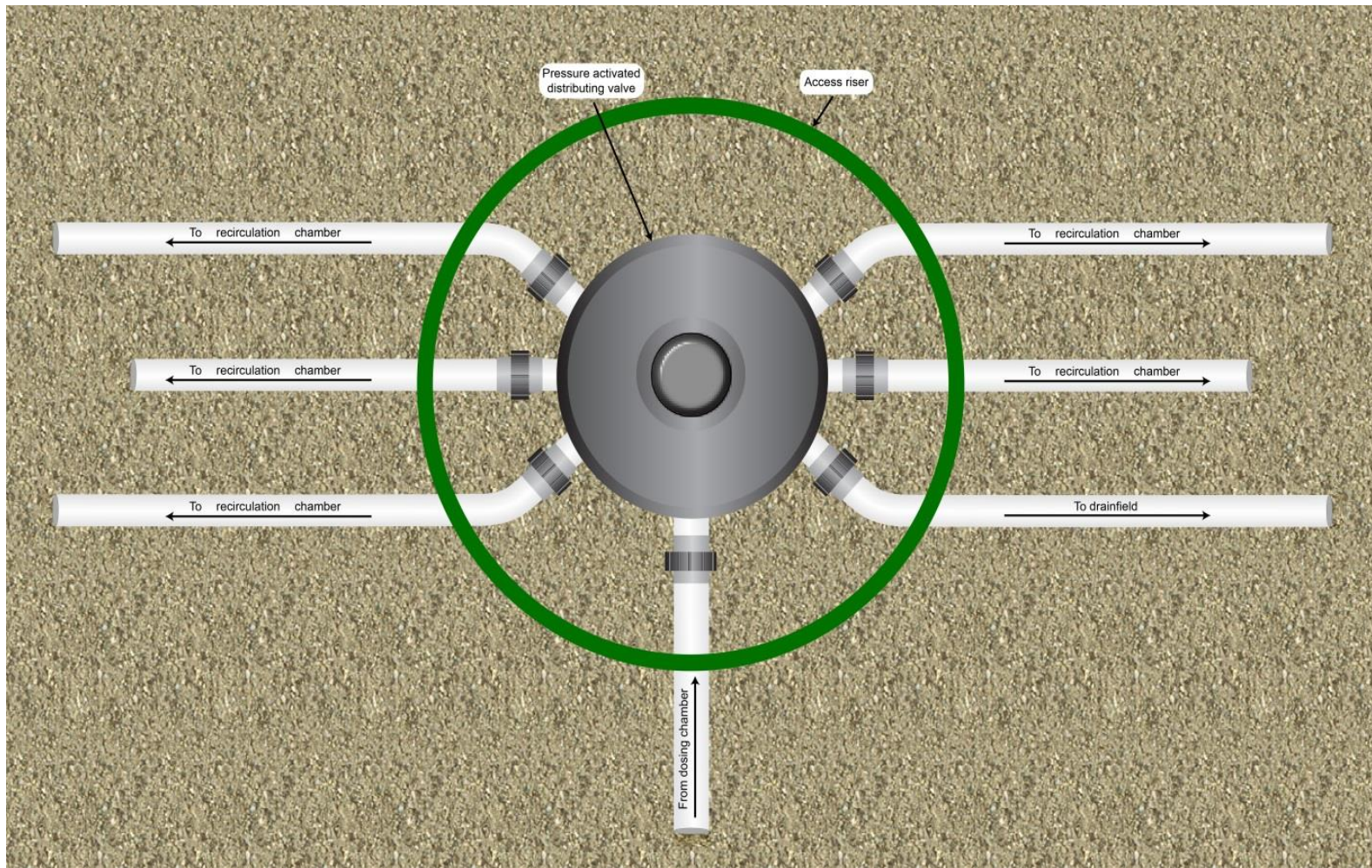

Figure 4-29. Overhead view of a mechanical flow splitter for pressure distribution that only delivers wastewater to one transport pipe with each dose.

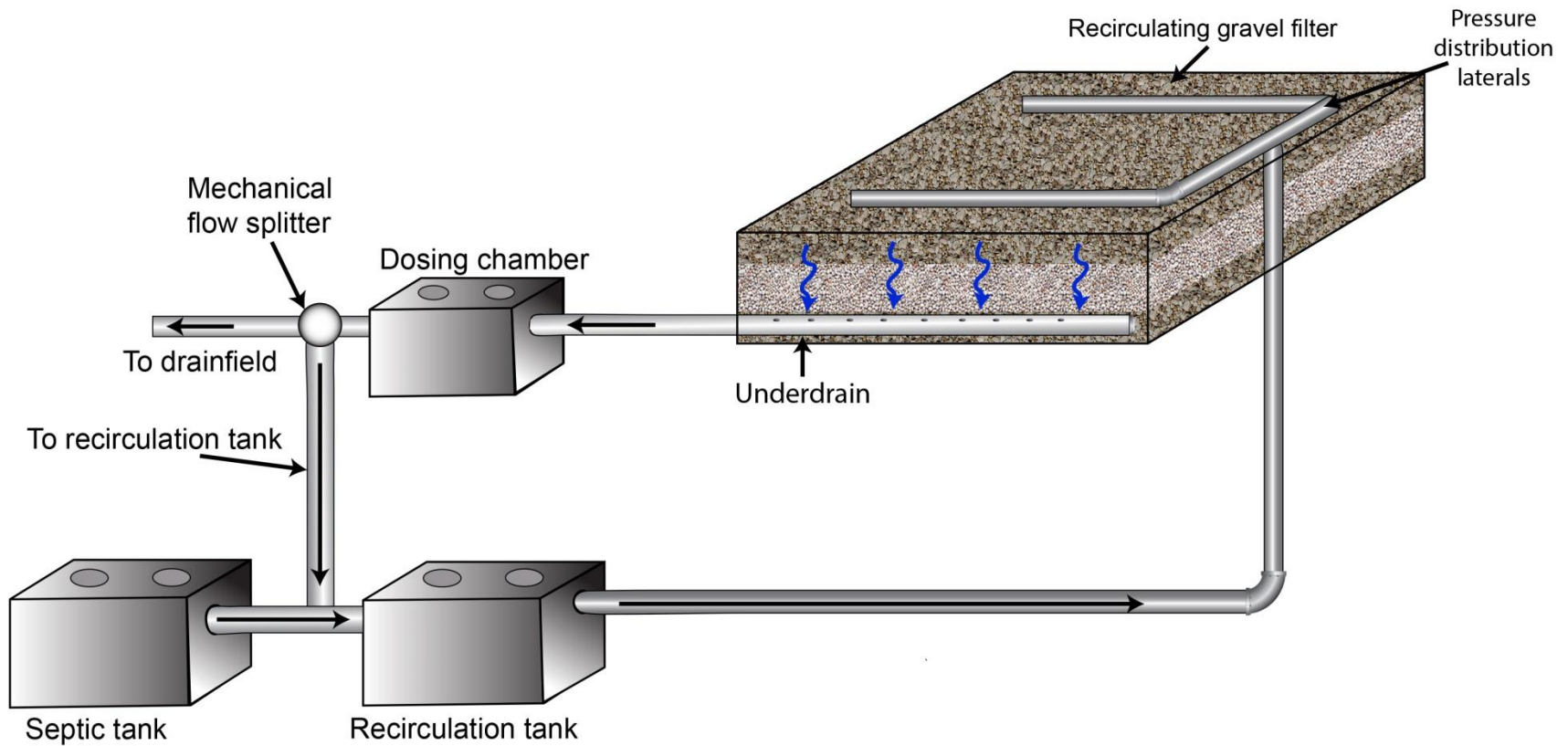

Figure 4-30. Cross section of a recirculating gravel filter system with pressure transport to, and/or within, the drainfield.

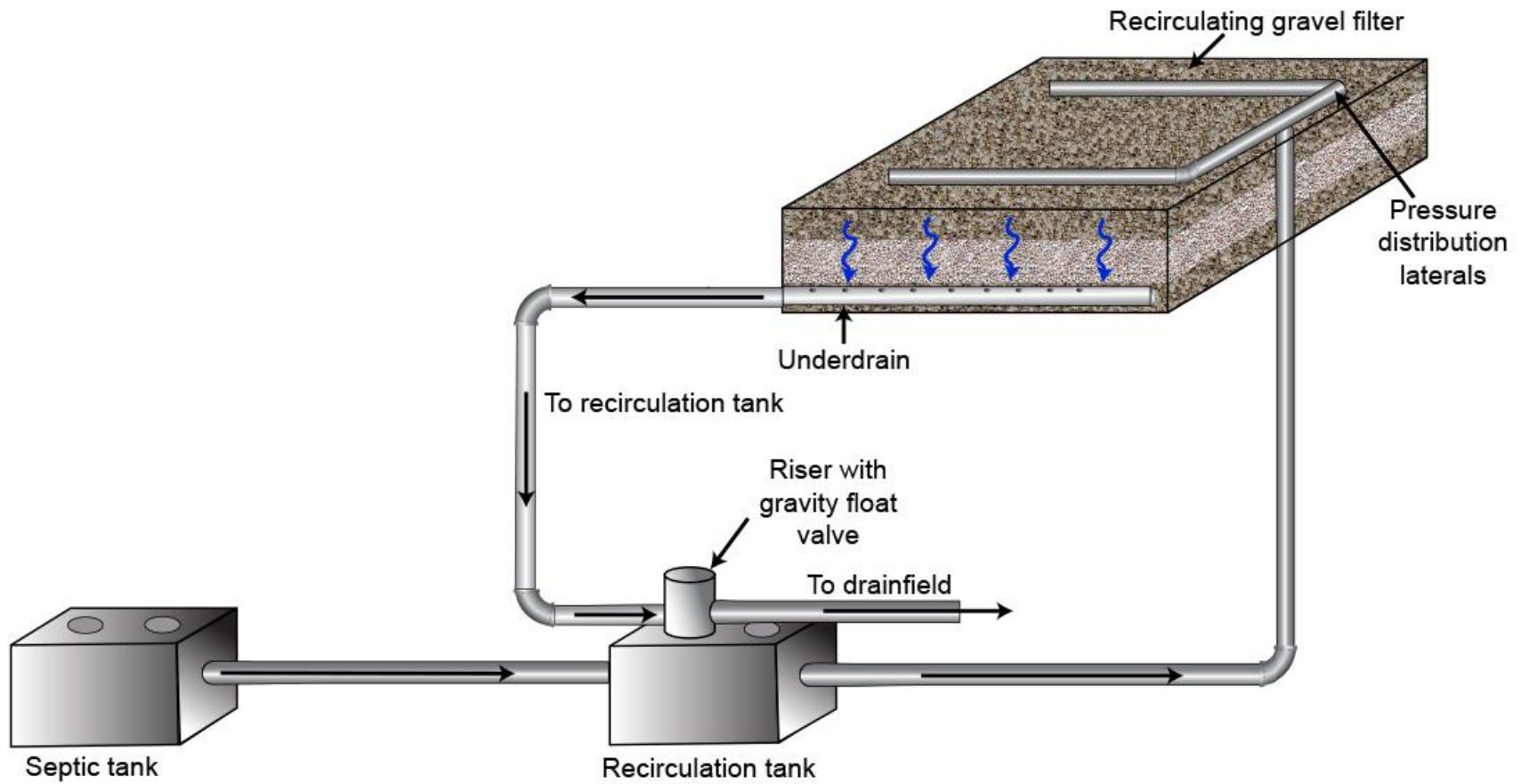

Figure 4-31. Cross section of a recirculating gravel filter system with gravity transport to the drainfield.



#### 4.21.3.4 Additional Design Elements for Recirculating Gravel Filter Systems Required to Reduce Total Nitrogen

##### 4.21.3.4.1 Equalization Tank

1. An equalization tank is required for all recirculating gravel filters treating effluent for total nitrogen.
2. A septic tank sized according to IDAPA 58.01.03.007.07 shall precede the equalization tank.
3. Minimum equalization tank volume shall be capable of maintaining two times the sum of the daily design flow of the system and recirculation volume returned to the equalization tank.
4. The equalization tank may be a modified septic tank or dosing chamber selected from section 5.2 or section 5.3.
  - a. Alternatively, the equalization tank may be designed by the system's design engineer to meet the minimum requirements of this section and IDAPA 58.01.03.007.
  - b. Equalization tank design is exempt from subsections .07 and .08 of IDAPA 58.01.03.007.
5. The recirculating filter effluent return point shall be located before the equalization tank and shall enter at the inlet of the equalization tank.

##### 4.21.3.4.2 Effluent Return

1. Effluent shall be returned from the recirculating gravel filter in a ratio of 20% to the equalization tank and 80% to the recirculation tank (Figure 4-32).
2. Effluent return from the filter to the equalization tank and recirculation tank may be done by gravity or under pressure.
3. The design engineer must specify how the return ratio will be met with the system design, and document the return flow in the system design calculations (Figure 4-33 and Figure 4-34).

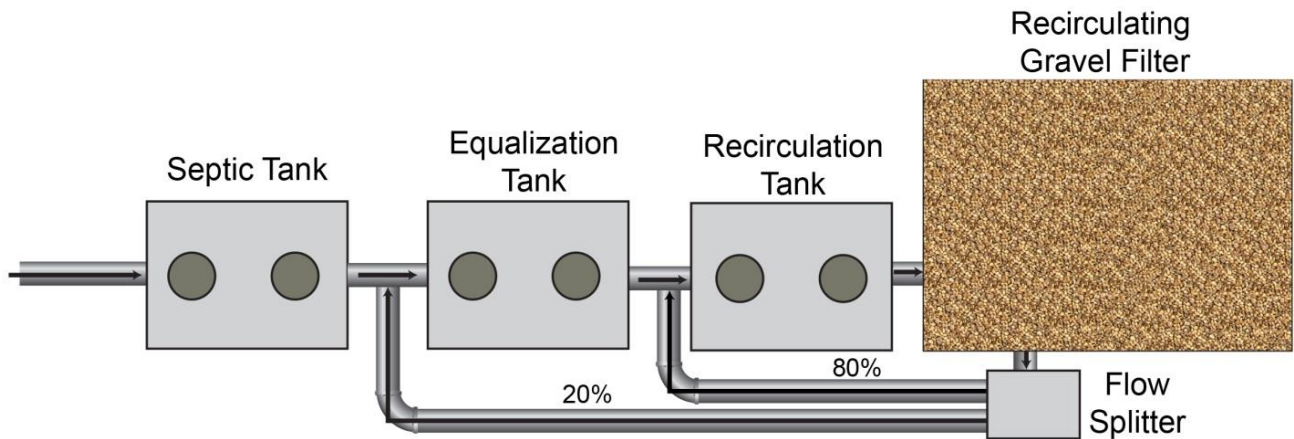

**Figure 4-32. Effluent return locations and ratios from the recirculating gravel filter and flow splitter for systems treating total nitrogen.**

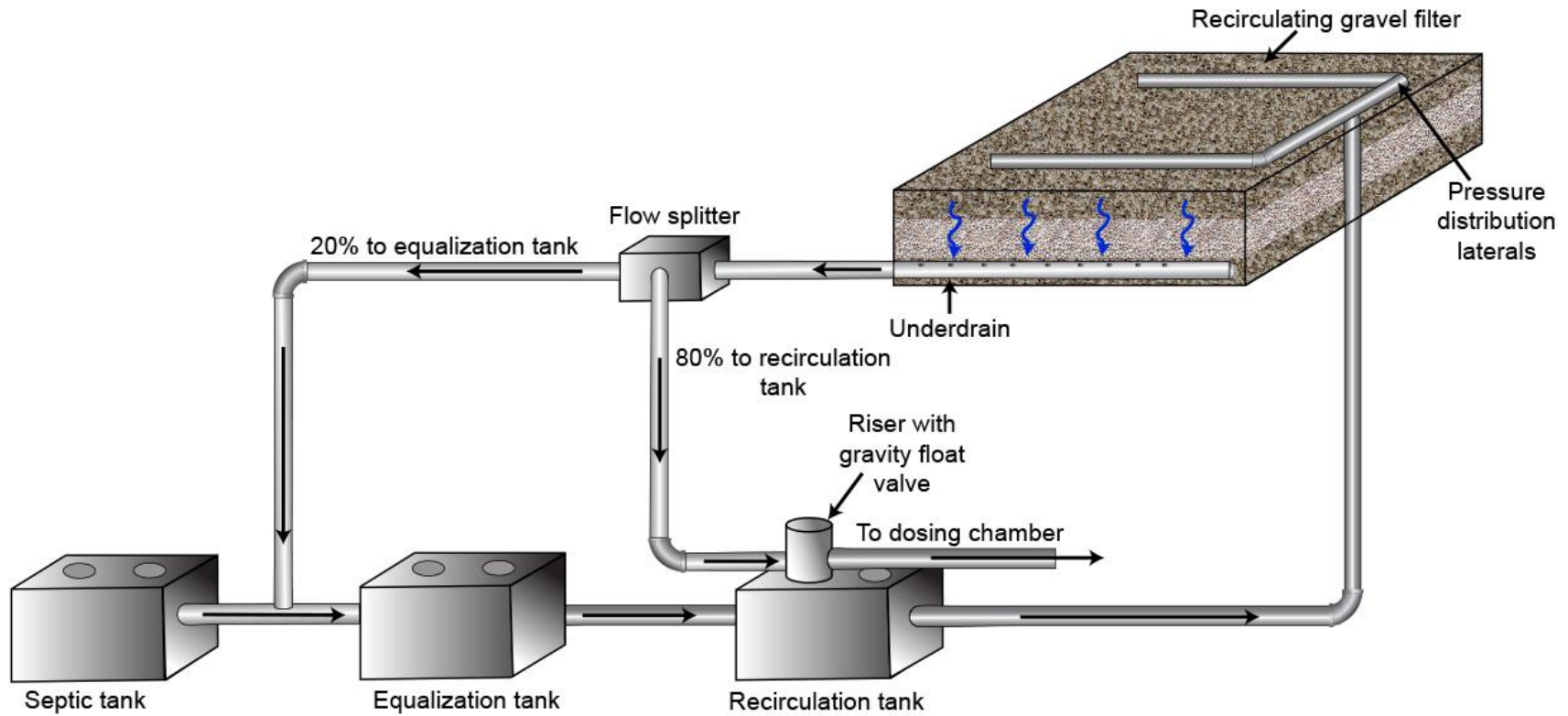

Figure 4-33. Cross section of a nitrogen-reducing recirculating gravel filter system with pressure transport to, and/or within the drainfield.

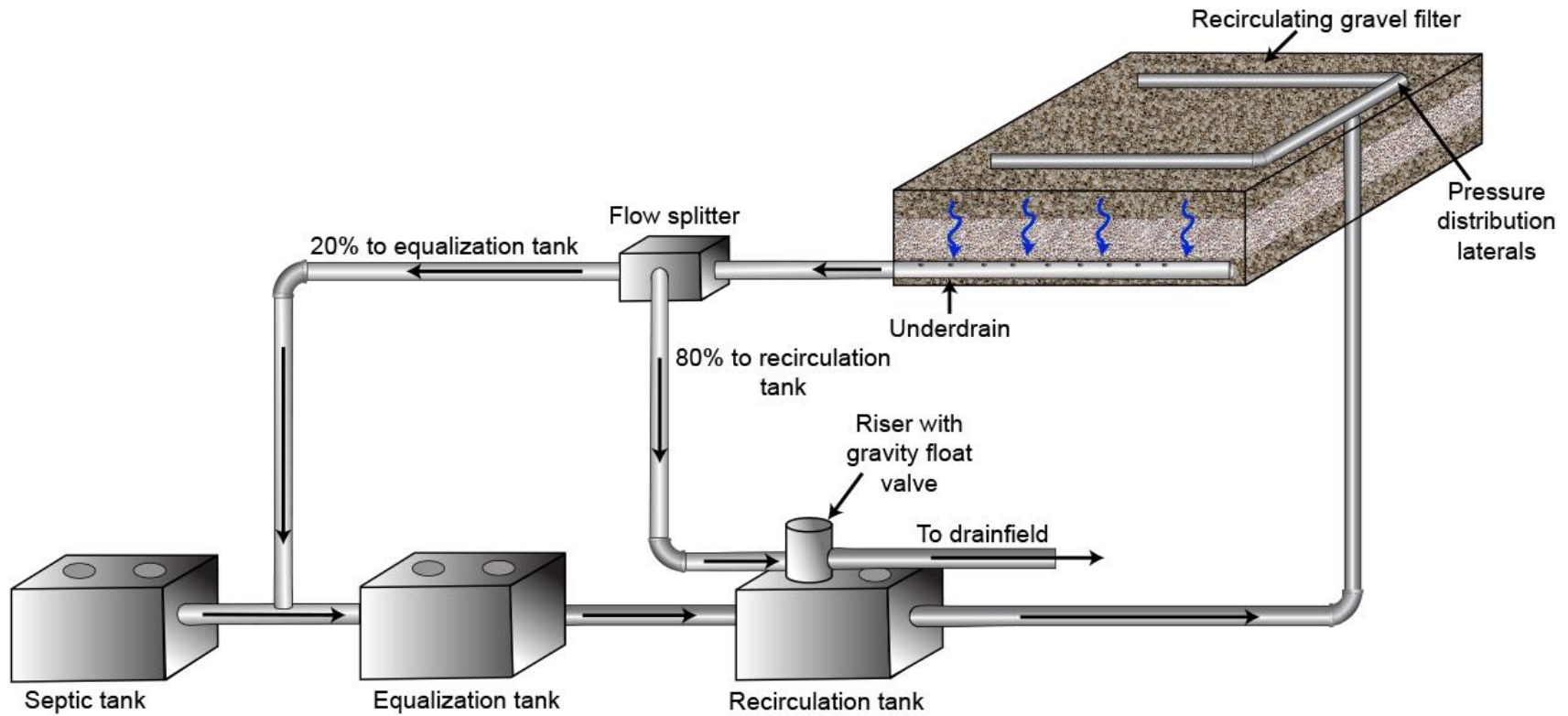

Figure 4-34. Cross section of a nitrogen-reducing recirculating gravel filter system with gravity transport to the drainfield.

**4.21.4 Filter Construction**

1. All materials must be structurally sound, durable, and capable of withstanding normal installation and operation stresses.
2. Components that may be subject to excessive wear must be readily accessible for repair or replacement.
3. All filter containers must be placed over a stable level base.
4. Geotextile filter fabric shall be placed only over the top of the filter and must not be used in-between the filter construction media and underdrain aggregate.
5. Access to the filter surface must be provided to facilitate maintenance.

**4.21.5 Drainfield Trenches**

1. Distances shown in Table 4-19 must be maintained between the trench bottom and limiting layer.
2. Pressure distribution, when used, shall meet the following design considerations:
  - a. If a pressure distribution system is designed within the drainfield, it must be designed according to section 4.19.
  - b. If the pressurized line from the mechanical flow splitter breaks to gravity before the drainfield, it must be done according to section 4.19.3.6.
  - c. The recirculation tank and recirculating filter may not be used as the dosing chamber for the drainfield or for flow-splitting purposes.
3. The minimum area, in square feet of bottom trench surface, shall be calculated from the maximum daily flow of effluent divided by the hydraulic application rate for the applicable soil design subgroup listed in Table 4-20.

**Table 4-19. Recirculating gravel filter vertical separation to limiting layers (feet).**

Limiting Layer	Flow < 2,500 GPD	Flow ≥ 2,500 GPD
	All Soil Types	All Soil Types
Impermeable layer	2	4
Fractured rock or very porous layer	1	2
Normal high ground water	1	2
Seasonal high ground water	1	2

*Note:* gallons per day (GPD)

**Table 4-20. Secondary biological treatment system hydraulic application rates.**

Soil Design Subgroup	Application Rate (gallons/square foot/day)
A-1	1.7
A-2a	1.2
A-2b	1.0
B-1	0.8
B-2	0.6
C-1	0.4
C-2	0.3

**4.21.6 Inspection**

1. A preconstruction meeting between the health district, responsible charge engineer, and installer should occur before commencing any construction activities.
2. The health district should inspect all system components before backfilling and inspect the filter container construction before filling with drainrock and filter construction media.
3. The responsible charge engineer shall conduct as many inspections as needed to verify system and component compliance with the engineered plans.
4. The responsible charge engineer shall provide the health district with a written statement that the system was constructed and functions in compliance with the approved plans and specifications. Additionally, the responsible charge engineer shall provide as-built plans to the health district if any construction deviations occur from the permitted construction plans (IDAPA 58.01.03.005.15).

**4.21.7 Operation and Maintenance**

1. The recirculating gravel filter design engineer shall provide a copy of the system’s OMM procedures to the health district as part of the permit application and before subsurface sewage disposal permit issuance (IDAPA 58.01.03.005.04.k).
2. Minimum OMM requirements should follow each system component manufacturer’s recommendations.
3. Instructions on how to trouble shoot the pump control panel should be included to allow adjustment to pump cycle timing if the low-level off or high-level alarm switch is frequently tripped in order to maintain the minimum 5:1 recirculation ratio.
4. Operation and maintenance directions should be included describing replacement of the filter construction media and informing the system owner that a permit must be obtained from the health district for this activity.
5. Maintenance of the septic tank should be included in the O&M manual.
6. All pressure distribution system components should be maintained as described in section 4.19.5.

7. Check for ponding at the filter construction media/underdrain aggregate interface through the observation tube in the recirculating filter.
8. Clean the surface of the filter regularly to remove leaves and other organic matter that may accumulate in the aggregate or rock cover.
9. Regularly check the recirculating gravel filter for surface odors. Odors should not be present and indicate that something is wrong. Odors are likely evidence that the dissolved oxygen in the filter is being depleted and that BOD and ammonia removal are being impacted.

## 4.22 Intermittent Sand Filter

Revision: February 4, 2016

Installer registration permit: Complex

Licensed professional engineer required: Yes

### 4.22.1 Description

An intermittent sand filter is a bed of medium sand in a container that filters and biologically treats septic tank effluent. Effluent is pressure dosed across the top of the medium sand in small doses and percolates through the filter media. The filter effluent is then collected by an underdrain at the bottom of the filter and is distributed to a disposal trench of reduced dimension. Components of the intermittent sand filter include a septic tank, dosing chamber, pump (or siphon) and controls, distribution network, sand filter, and drainfield.

### 4.22.2 Approval Conditions

1. The system must be designed by a PE licensed in Idaho.
2. All pressure distribution components shall be designed according to the pressure distribution system guidance (section 4.19).
3. The design engineer shall provide an O&M manual for the system to the health district before permit issuance.
4. The intermittent sand filter container shall meet the same separation distance requirements as a septic tank.
5. The bottom of the filter must not come within 12 inches of seasonal high ground water.
6. Effluent shall not discharge to the drainfield without passing through the filter first.
7. Nondomestic wastewater must be pretreated to residential strength before discharge to the intermittent sand filter.

### 4.22.3 Design Requirements

Minimum design requirements for the intermittent sand filter components are provided below.

#### 4.22.3.1 Intermittent Filter

1. The filter container shall be constructed of reinforced concrete or other materials where equivalent function, workmanship, watertightness, and at least a 20-year service life can be documented.
2. The following requirements must be met for flexible membrane liners:
  - a. Have properties equivalent to, or greater than, 30-mil PVC.
  - b. Have field repair instructions and materials provided to the purchaser of the liner.
  - c. Have factory-fabricated *boots* for waterproof field bonding of piping to the liner.
  - d. Liner must be placed against smooth, regular surfaces free of sharp edges, nails, wire, splinters, or other objects that may puncture the liner. Provide a 4-inch layer of clean sand for liner protection.
3. Application rate of septic tank effluent to the filter must be 0.7 gallons/ft<sup>2</sup>/day.

4. Filter construction media shall meet the specification in section 3.2.8.1 for drainrock, section 3.2.8.1.2 for medium sand, and section 3.2.8.1.3 for pea gravel.
  - a. Medium sand should be placed in a maximum of 8-inch lifts.
  - b. Each lift should be wetted before installation of the next lift to minimize settling.
5. Minimum filter construction specifications (i.e., media depth, geotextile fabric placement, cover depth and slopes, filter container height, and piping placement) shall meet the dimensions and locations depicted in (Figure 4-35).
6. The bottom of the filter should be sloped at least 1% to the underdrain pipe for flexible membrane liners.
7. An underdrain must be located at the bottom of the filter to drain the intermittent filter meeting the following requirements:
  - a. May be placed directly on the bottom of the filter.
  - b. Placed level throughout the filter.
  - c. Constructed of slotted drain pipe with 0.25-inch slots 2.5 inches deep and spaced 4 inches apart located vertically on the top of the pipe, or perforated sewer drain pipe with holes located at 5 and 7 o'clock.
  - d. One underdrain should be installed for each filter cell zone.
  - e. The distal end is vented to the atmosphere, protected with a screen, and located within the filter to allow entry of air flow into the bottom of the filter and access for cleaning and ponding observation.
  - f. Connected to solid pipe that meets the construction requirements of IDAPA 58.01.03.007.21, extends through the filter, and is sealed so the joint between the filter wall and pipe is watertight.
  - g. If gravity flow is not achievable from the underdrain to the drainfield, the underdrain must be connected to an approved dosing chamber (section 5.3) or an approved septic tank (section 5.2) modified to a dosing chamber that is sized and constructed as described in section 4.19.3.4 to deliver effluent to the drainfield by pressure transportation or distribution. Dosing of the drainfield may not occur from a pump that is located within the intermittent sand filter.
8. Two observation tubes should be placed in the intermittent sand filter to monitor for ponding and clogging formation.
  - a. The monitoring tubes must be secured and perforated near the bottom.
  - b. The monitoring tubes must extend through the intermittent filter cover and have a removable cap.
9. The surface of the intermittent sand filter shall be covered meeting the following requirements:
  - a. The soil cover shall be graded to divert any surface waters away from the intermittent sand filter.
  - b. Vegetation on top of the soil cover must be managed so that deep-rooting vegetation does not plug the distribution system.
  - c. The design engineer should account for potential freezing conditions in the design of the intermittent sand filter and pressure distribution system.



### **4.22.3.2 Intermittent Filter Cells**

Depending on the volume of effluent and type of structure using an intermittent sand filter, the intermittent filter may need to be split into cells that contain dosing zones. A filter cell is the total filter area that can be served by a single dosing pump or set of pumps. Cell sizing is limited to 600 GPD. The minimum filter design requirements for cells and pumps include the following:

1. Filter cells are hydraulically isolated from one another and shall be constructed according to the minimum requirements in section 4.22.3.
2. Each cell shall be equivalent in surface area and volume.
3. Each cell shall receive equal volumes of wastewater per dose.

### **4.22.3.3 Intermittent Filter Dosing**

1. Timed dosing is required, and the filter dosing cycle should meet the following minimum recommendations:
  - a. Pumps are set to dose each cell once per hour.
  - b. Dose volume delivered to the filter surface for each cycle should be 5% of the daily design flow.
  - c. A pump on override float should be set at a point that equates to 70% of the dosing chamber's volume.
  - d. A high-level audio and visual alarm float should be set at 90% of the dosing chamber's volume.
  - e. A low-level off float should be placed to ensure that the pump remains fully submerged at all times.
2. The pump controls should meet the following:
  - a. Be capable of monitoring low- and high-level events so that timer settings can be adjusted accordingly.
  - b. Have event counters and run-time meters to be able to monitor daily flows.

Figure 4-35 provides a cross-sectional view of an intermittent sand filter cell.

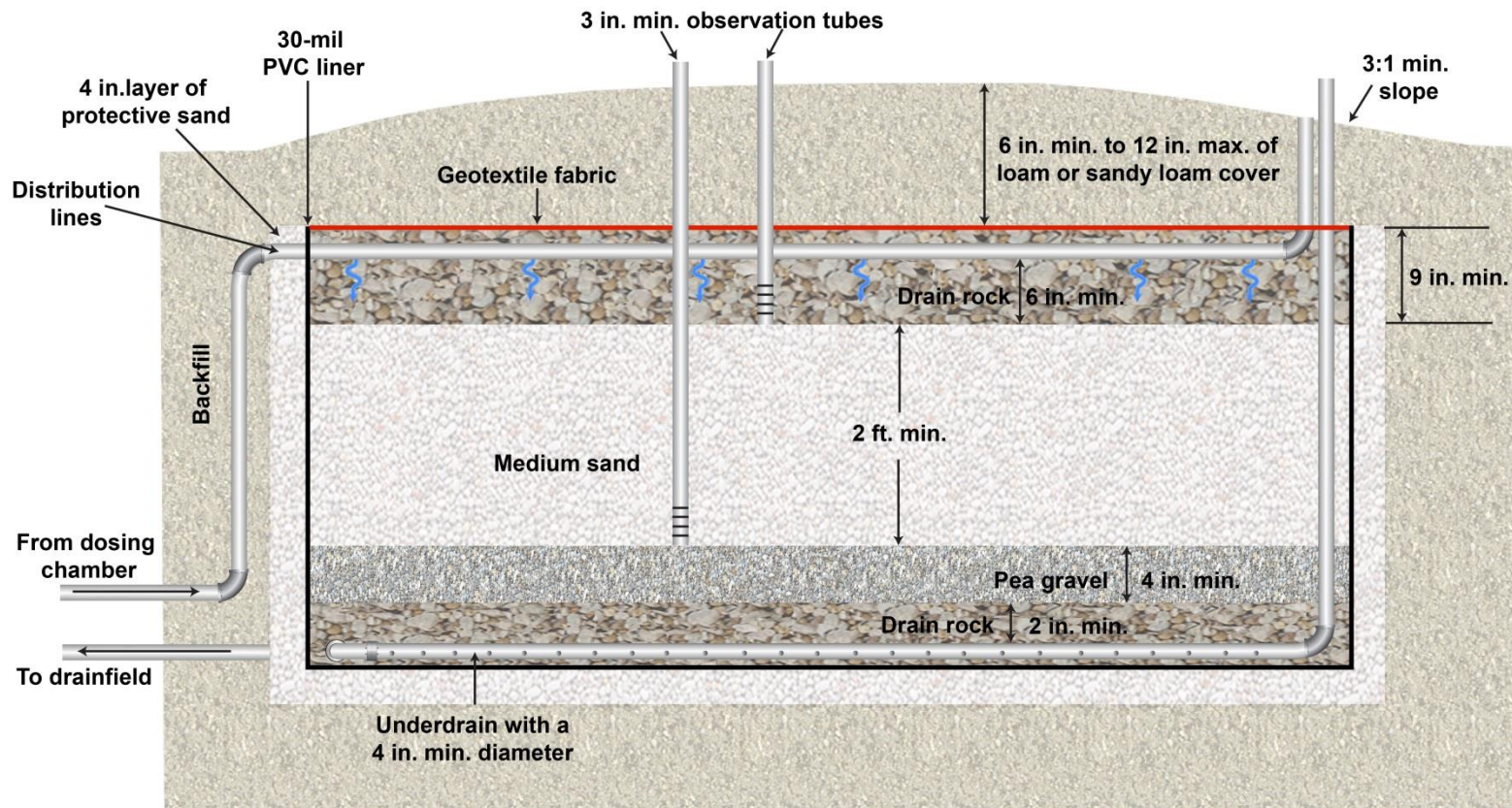

Figure 4-35. Cross section of flexible membrane intermittent sand filter cell.

#### 4.22.4 Drainfield Trenches

1. Distances shown in Table 4-21 must be maintained between the trench bottom and limiting layer.
2. Capping fill may be used to obtain adequate separation distance from limiting layers but must be designed and constructed according to the guidance for capping fill trenches in section 4.3.
3. Pressure distribution may be used with the following design considerations:
  - a. The pressure distribution system related to the drainfield is designed according to section 4.19.
  - b. The dosing chamber for the intermittent sand filter may not be used as the dosing chamber for the drainfield.
4. The drainfield shall be sized by dividing the maximum daily flow by the hydraulic application rate for the applicable soil design subgroup listed in Table 4-22.

**Table 4-21. Intermittent sand filter vertical setback to limiting layers (feet).**

Limiting Layer	Flow < 2,500 GPD	Flow ≥ 2,500 GPD
	All Soil Types	All Soil Types
Impermeable layer	2	4
Fractured rock or very porous layer	1	2
Normal high ground water	1	2
Seasonal high ground water	1	2

Note: gallons per day (GPD)

**Table 4-22. Secondary biological treatment system hydraulic application rates.**

Soil Design Subgroup	Application Rate (gallons/square foot/day)
A-1	1.7
A-2a	1.2
A-2b	1.0
B-1	0.8
B-2	0.6
C-1	0.4
C-2	0.3

#### 4.22.5 Inspection

1. A preconstruction meeting between the health district, responsible charge engineer, and installer should occur before commencing any construction activities.
2. The health district should inspect all system components before backfilling and inspect the filter container construction before filling with drainrock and filter construction media.
3. The responsible charge engineer shall conduct as many inspections as needed to verify system and component compliance with the engineered plans.
4. The responsible charge engineer shall provide the health district with a written statement that the system was constructed and functions in compliance with the approved plans and specifications. Additionally, the responsible charge engineer shall provide as-built plans to the health district if any construction deviations occur from the permitted construction plans (IDAPA 58.01.03.005.15).

#### 4.22.6 Operation and Maintenance

1. The intermittent sand filter design engineer shall provide a copy of the system's OMM procedures to the health district as part of the permit application and prior to subsurface sewage disposal permit issuance (IDAPA 58.01.03.005.04.k).
2. Minimum OMM requirements should follow each system component manufacturer's recommendations.
3. Instructions on how to trouble shoot the pump control panel should be included to allow adjustment to pump cycle timing if the low-level off or high-level alarm switch is frequently tripped in order to maintain the hourly dosing cycle timing.
4. Operation and maintenance directions should be included describing the replacement of the filter construction media and informing the system owner that a repair permit must be obtained from the health district for this activity.
5. Maintenance of the septic tank shall be included in the O&M manual.
6. All pressure distribution system components shall be maintained as described in section 4.19.5.
7. Check for ponding in the intermittent sand filter observation ports.
8. Vegetation over the intermittent sand filter should be maintained regularly.
9. Sludge depth in the septic tank should be checked annually, and the tank shall be pumped when sludge exceeds 40% of the liquid depth.

Figure 4-36 shows a cross section of an intermittent sand filter system with gravity distribution to the drainfield. Figure 4-37 shows a cross section of an intermittent sand filter system with pressure transport to, and/or distribution within, the drainfield.

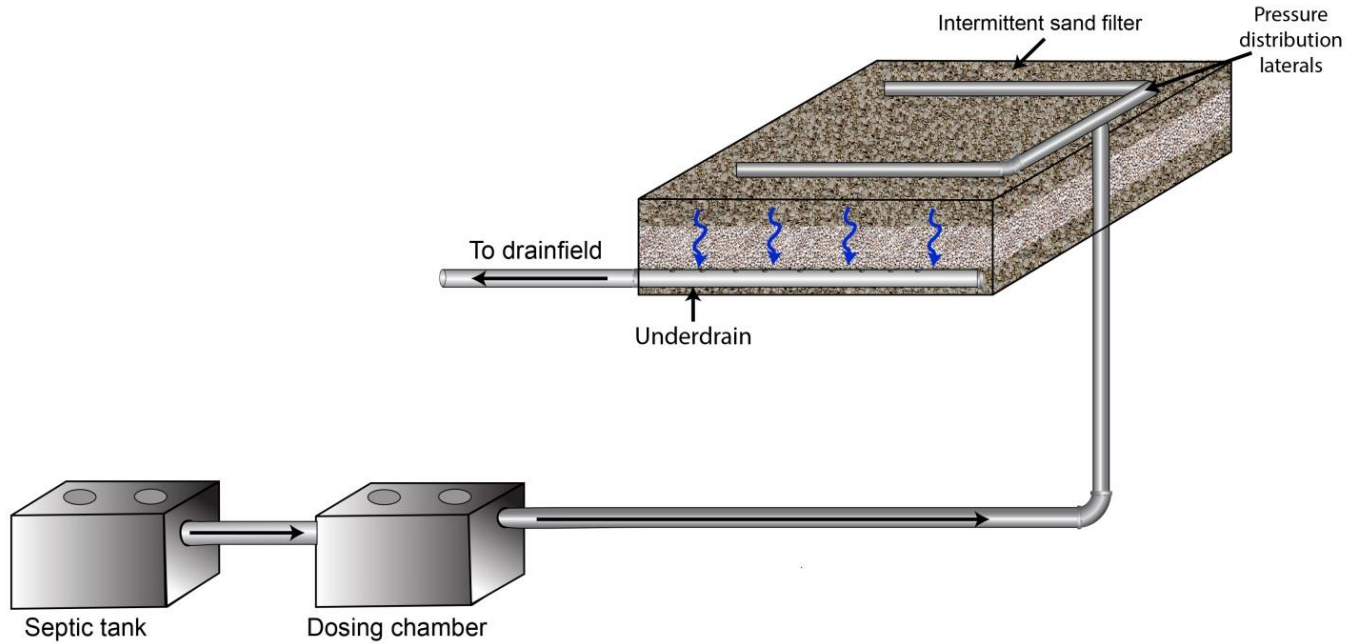

**Figure 4-36. Cross section of an intermittent sand filter system with gravity discharge to the drainfield.**

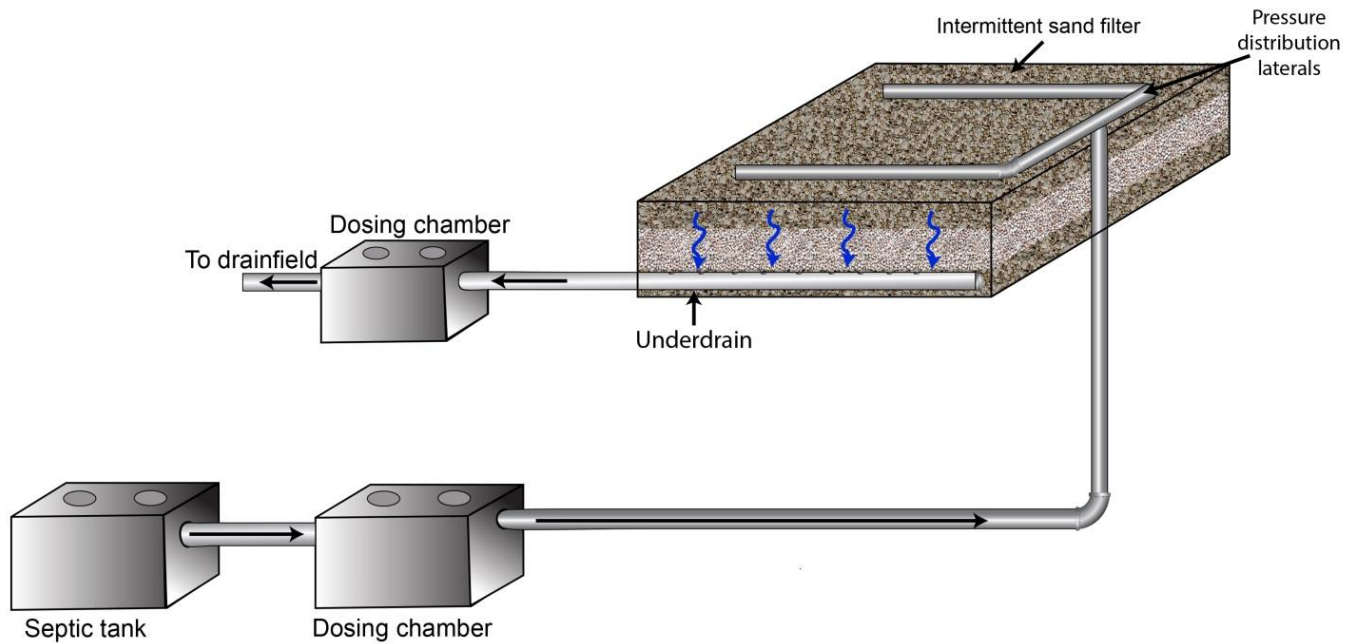

**Figure 4-37. Cross section of an intermittent sand filter system with pressure transport to and/or distribution within the drainfield.**

## 4.23 In-Trench Sand Filter

Revision: September 24, 2019

Installer registration permit: Property owner or standard and basic (complex if pretreated and pressurized enveloped)

Licensed professional engineer required: No (yes if pressurized enveloped)

### 4.23.1 Description

An in-trench sand filter is a standard trench or bed system receiving effluent by either gravity or low-pressure flow, under which is placed a filter of manufactured medium sand meeting the definitions provided in section 3.2.8.1.2. There are two classifications of an in-trench sand filter:

- Standard in-trench sand filter
- Enveloped in-trench sand filter

The standard design is typically used to excavate through impermeable or unsuitable soil layers down to suitable permeable soils. The standard design may also have clean pit run sand and gravel placed between the manufactured medium sand and the suitable permeable soils or ground water as long as minimum manufactured medium sand depths are used. A basic installer's permit may be used to install gravity flow in-trench sand filters that are not preceded by any complex alternative system components.

Standard in-trench sand filter drainfields may be installed at depths where the sidewalls of the drainfield are located in impermeable or unsuitable soil to address sites that cannot meet the requirements of IDAPA 58.01.03.008.02.b. Unsuitable soils must have application rates  $<0.2$  GPD/ft<sup>2</sup> (Table 2-4). Unsuitable soils with application rates  $>1.2$  GPD/ft<sup>2</sup> (Table 2-4) must use an enveloped in-trench sand filter design.

A modified design to the standard in-trench sand filter is known as the enveloped in-trench sand filter. Enveloped in-trench sand filters consist of a disposal trench with manufactured medium sand placed below and to the sides of the drainfield and are used for sites with native soils consisting of coarse to very coarse sand or gravel. The enveloped in-trench sand filter has three subcategories based on effluent distribution and treatment (section 4.23.3.2).

The term drainfield only applies to the aggregate as defined in IDAPA 58.01.03.008.08 or the gravelless trench components approved in section 5.6 of this manual. Manufactured medium sand and pit run may be installed deeper than 48 inches below grade as long as the drainfield maintains a maximum installation depth of 48 inches below grade in compliance with IDAPA 58.01.03.008.04. Minimum installation depths must meet the capping fill trench requirements as outlined in section 4.3.

### 4.23.2 Approval Conditions

1. Except as specified herein, the system must meet the dimensional and construction requirements of a standard trench, bed, or pressure distribution system.
2. Any subclassification of an in-trench sand filter may be used over very porous strata, coarse sand and gravel, or ground water.

3. A basic permitted installer may install standard or standard enveloped gravity flow in-trench sand filters that are not preceded by any complex alternative system components.
4. A permitted complex installer is required to install a pretreated enveloped in-trench sand filter, pressurized enveloped in-trench sand filter, or any other in-trench sand filters that are preceded by, or contain, a complex system component.
5. Manufactured medium sand used in filter construction must conform to the gradation requirements as described in section 3.2.8.1.2.
6. Pit run backfill material, if used, must conform to the gradation requirements as described in section 3.2.8.1.4.

### **4.23.3 Design and Construction Requirements**

Each classification of the in-trench sand filter has its own unique minimum design and construction criteria that must be followed. The following subsections describe the minimum design and construction requirements for each classification of the in-trench sand filter.

#### **4.23.3.1 Standard In-Trench Sand Filter Design and Construction**

1. Minimum manufactured medium sand depths depend upon site-specific soil profiles.
2. There is no minimum manufactured medium sand depth if seasonal ground water or a porous limiting layer is not present (see example 2 in section 2.2.5.2).
3. If seasonal ground water or a porous limiting layer is present the minimum manufactured medium sand and pit run depths are dependent upon meeting the method of 72 as outlined in section 2.2.5.2 (Figure 4-38).
4. Pit run material may only be installed at depths of 7 feet below grade or more; manufactured medium sand must be used from the bottom of the drainfield to a depth of 7 feet below grade regardless of the drainfield installation depth.
5. The standard in-trench sand filter system shall be sized based on the most restrictive native receiving soil below the manufactured medium sand, or pit run, and native soil interface to a depth capable of meeting the method of 72 as described in section 2.2.5.2.
6. Standard in-trench sand filters must maintain a 12-inch minimum depth of suitable native soil below the filter above a porous or nonporous limiting layer (Figure 4-38).
7. Standard in-trench sand filters must maintain a minimum separation distance of 12 inches from the bottom of the drainfield to the seasonal high ground water level.
8. Standard in-trench sand filters must maintain a separation distance from the bottom of the drainfield and any limiting layer that is capable of meeting the method of 72 as described in section 2.2.5.2.

Design and construction condition 8 may be waived if the standard in-trench sand filter is preceded by an alternative pretreatment system (e.g., ETPS, intermittent sand filter, or recirculating gravel filter) as long as the bottom of the drainfield still meets the minimum separation distances of the applicable alternative pretreatment system.

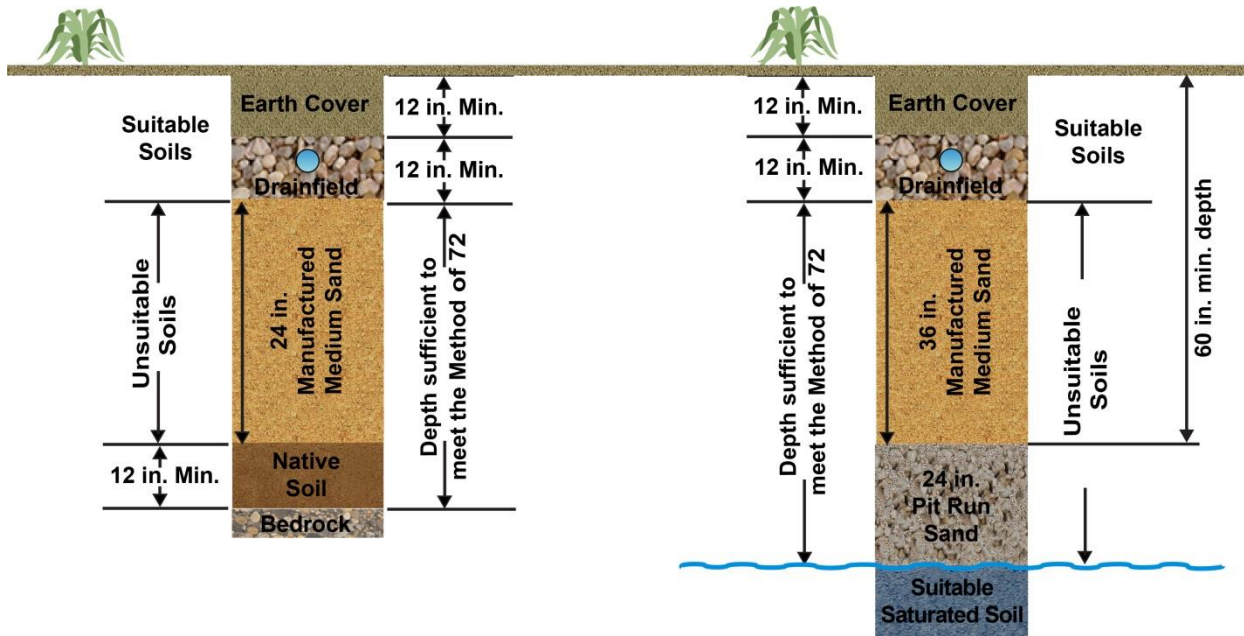

Figure 4-38. In-trench sand filter accessing suitable soils through an unsuitable soil layer.

#### 4.23.3.2 Enveloped In-Trench Sand Filter Design and Construction

The three subcategories of the enveloped in-trench sand filter include in-trench sand filters that receive the following:

- Standard domestic strength effluent
- Pretreated effluent
- Pressure distributed effluent

All the subcategories of enveloped in-trench sand filters have the following same design and construction requirements:

1. The filter sand shall envelop the drainfield so that at least 12 inches of manufactured medium sand is between the sides and ends of the drainfield and native soils.
2. Effective disposal area for installing an enveloped in-trench sand filter shall only be credited for the width and length of the drainfield installed. Manufactured medium sand width enveloping the drainfield is not credited as disposal area.
3. Enveloped in-trench sand filters may not be used in large soil absorption system designs.

Additionally, each subcategory has design and construction criteria that are independent of the other subcategories. The following subsections describe the minimum independent design and construction requirements for each subcategory of the enveloped in-trench sand filter.

##### 4.23.3.2.1 Standard Enveloped In-Trench Sand Filter Design and Construction

1. The native site soils consist of unsuitable coarse to very coarse sand or gravel meeting the equivalent diameters described in Table 2-1.



2. Unsuitable soils that have application rates less than clay loam as described in Table 2-4 are not suitable for installation of an enveloped in-trench sand filter.
3. The minimum depth of filter sand below the drainfield shall be 3 feet (Figure 4-39).
4. The enveloped in-trench sand filter must maintain a minimum of 12 inches above any limiting layer from the bottom of the filter sand.
5. The drainfield shall be sized at 1.2 GPD/ft<sup>2</sup>.

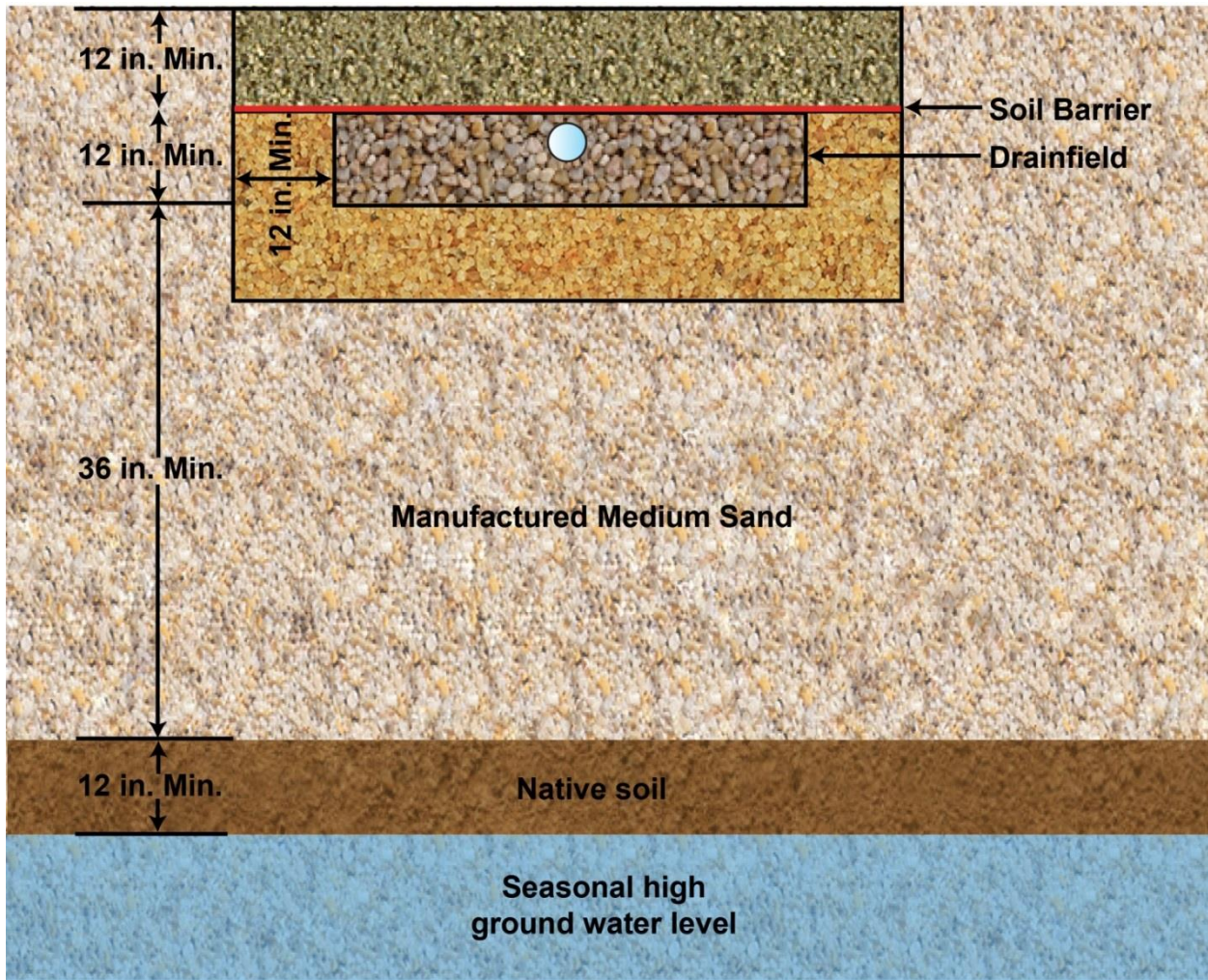

Figure 4-39. Standard enveloped in-trench sand filter for installation in coarse native soils (i.e., coarse or very coarse sand or gravel).

#### 4.23.3.2.2 Pretreated Enveloped In-Trench Sand Filter Design and Construction

1. The effluent shall be pretreated with an extended treatment package system (section 4.8), recirculating gravel filter (section 4.21) or intermittent sand filter (section 4.22).
2. The native site soils shall consist of unsuitable coarse to very coarse sand or gravel meeting the equivalent diameters described in Table 2-1.

3. Unsuitable soils that have application rates less than clay loam as described in Table 2-4 are not suitable for installation of an enveloped in-trench sand filter.
4. The minimum depth of filter sand below the drainfield shall be 12 inches (Figure 4-40).
5. The enveloped in-trench sand filter must maintain a minimum of 12 inches above seasonal or normal ground water levels and any other porous limiting layer from the bottom of the filter sand.
6. The enveloped in-trench sand filter must maintain a minimum of 12 inches above any nonporous limiting layer from the bottom of the filter sand.
7. The drainfield shall be sized at 1.7 GPD/ft<sup>2</sup>.

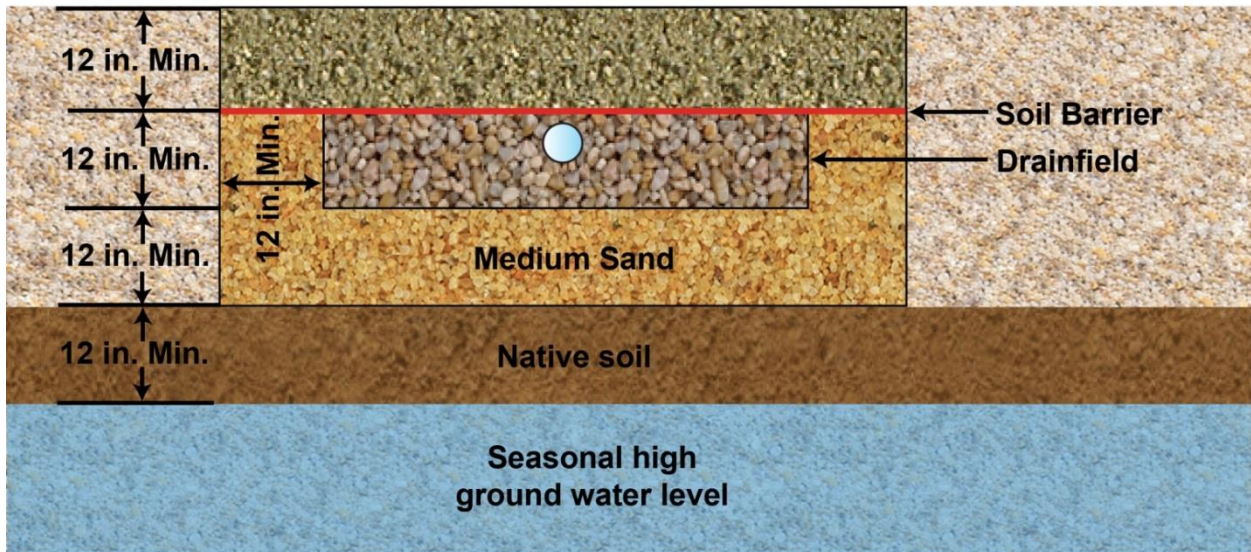

Figure 4-40. Enveloped in-trench sand filter with alternative pretreatment for installation in coarse native soils (i.e., coarse or very coarse sand or gravel).

#### 4.23.3.2.3 Pressurized Enveloped In-Trench Sand Filter Design and Construction

1. The native site soils shall consist of suitable soils no coarser than medium sand or finer than clay loam as described in Table 2-4.
2. The drainfield shall be pressurized and designed according to section 4.19 by a PE licensed in Idaho.
3. The filter sand shall maintain a minimum depth of (Figure 4-41).
  - a. 2 feet below the drainfield in design group C soils.
  - b. 3 feet below the drainfield in design group A and B soils.
4. A minimum of 12 inches of suitable soils must be maintained between the sand filter and an impermeable limiting layer or the normal high ground water level.
5. The pressurized enveloped in-trench sand filter system shall be sized based on the most restrictive native receiving soil between the bottom of the manufactured medium sand filter and the normal high ground water level or a porous limiting layer.

6. Reduced separation distances to nonporous limiting layers may not be approved through use of this design.
7. Pressurized enveloped in-trench sand filters installed in suitable soils to obtain a reduced separation distance to ground water or a porous limiting layer must maintain a minimum of 12 inches above the seasonal and normal high ground water levels from the bottom of the filter sand.

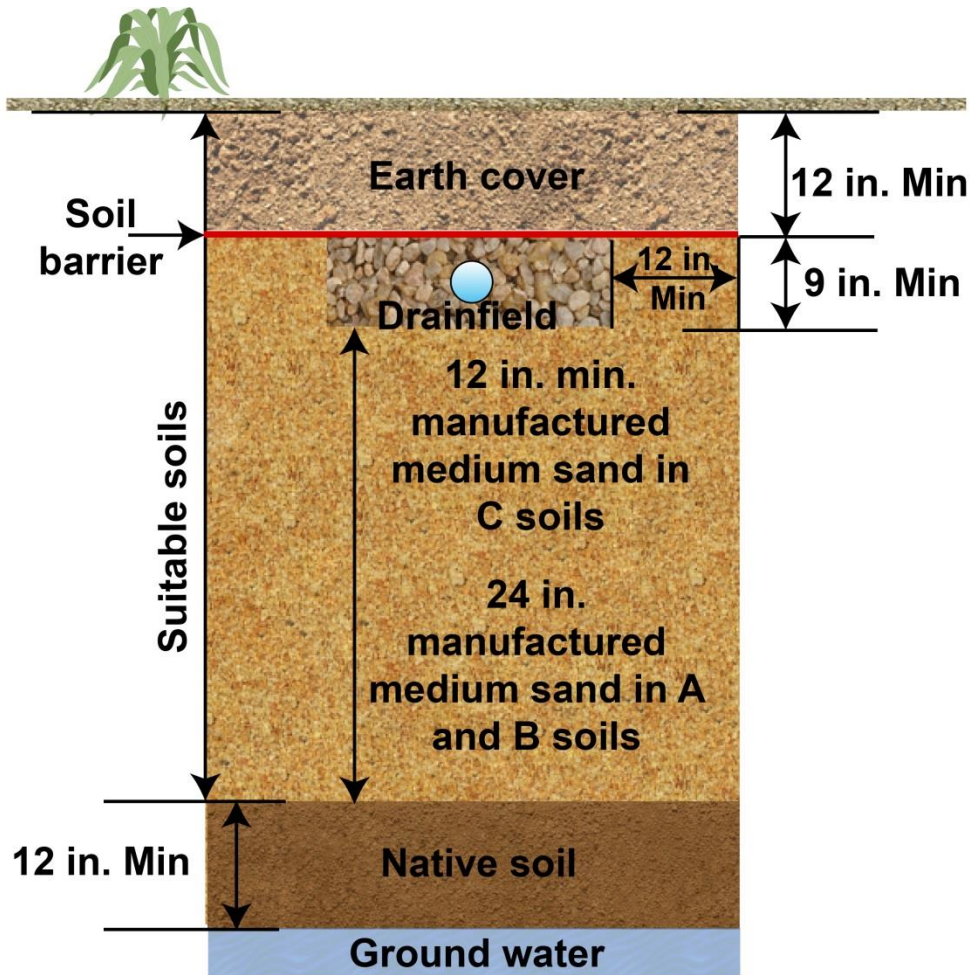

Figure 4-41. Enveloped pressurized in-trench sand filter for installation in suitable soils for a reduction in separation distance to ground water.

## 4.24 Sand Mound

Revision: March 4, 2019

Installer registration permit: Complex

Licensed professional engineer required: Yes

### 4.24.1 Description

A sand mound is a soil absorption facility consisting of a septic tank, dosing chamber, mound constructed of medium sand, a pressurized small-diameter pipe distribution system, and topsoil cap. Figure 4-42 provides a diagram of a sand mound.

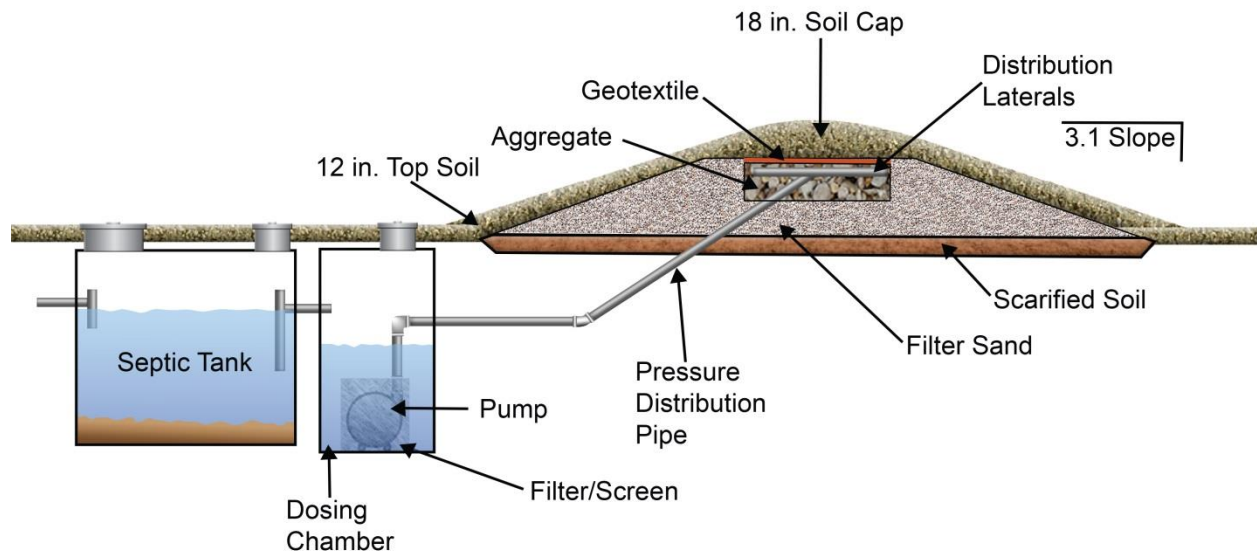

Figure 4-42. Cross-sectional view of sand mound.

### 4.24.2 Approval Conditions

1. Effective soil depth to limiting layers may vary depending upon thickness of filter sand beneath the absorption bed:
  - a. If 12 inches of filter sand is placed beneath the absorption bed, then Table 4-23 lists the minimum depth of natural soil to the limiting layer.
  - b. If 24 inches of filter sand is placed beneath the absorption bed, then Table 4-21 in Section 4.22 “Intermittent Sand Filter,” identifies the effective soil depth to limiting layers.
2. The soil application rate used in the sand mound design is based on the most restrictive soil layer within the soil profile’s effective soil depth as determined by approval condition 1 except that the effective sizing depth shall not be less than 18 inches.
3. Table 4-24 shows the maximum slope of natural ground, listed by soil design group.
4. Sand mound must not be installed in flood ways, areas with large trees and boulders, in concave slopes, at slope bases, or in depressions.

5. Minimum pretreatment of sewage before disposal to the mound must be a septic tank sized according to IDAPA 58.01.03.007.07.
6. The maximum daily wastewater flow to any mound or absorption bed cell must be equal to or less than 1,500 GPD.
7. Multiple mounds, or absorption bed cells, may be used to satisfy design requirements for systems larger than 1,500 GPD.
  - a. Appropriate valving should be used in the design to ensure that flows are evenly divided between all of the mounds or absorption bed cells.
  - b. Valving should be accessible from grade and insulated from freezing.
8. Design flow rate for the sand mound must be 1.5 times the wastewater daily flow required by IDAPA 58.01.03.007.08 or as determined in accordance with section 3.3 of this manual and is only used in designing the absorption bed cell and medium sand fill.
9. Pressure distribution system and associated component design shall conform to section 4.19 of this manual.

**Table 4-23. Minimum depth of natural soil to limiting layer.**

Soil Design Group	Extremely Impermeable Layer (feet)	Extremely Permeable Layer (feet)	Normal High Ground Water (feet)
A, B	3	3	3
C	3	2	2

**Table 4-24. Maximum slope of natural ground.**

Design Group	A	B	C-1	C-2
Slope (%)	20	20	12	6

### 4.24.3 Design Requirements

The sand mound has three different sections with different design criteria: absorption bed cell, medium sand fill, and soil cap. The minimum design criteria for each section are provided in the following subsections.

#### 4.24.3.1 Absorption Bed Cell Design

1. Only absorption beds may be used. The maximum absorption bed disposal area should be 2,250 ft<sup>2</sup> (A x B). Beds should be a maximum of 10 feet wide ( $B \leq 10$  feet). Beds should be as long and narrow as practical, particularly on sloped ground, to minimize basal loading. It is recommended that beds are less than 10 feet wide if site conditions will allow.
2. If multiple absorption bed cells are used in a sand mound design, a separation distance of 10 feet should be maintained between each cell (Figure 4-43).
3. Absorption bed cells should only be placed end to end in a single mound design.

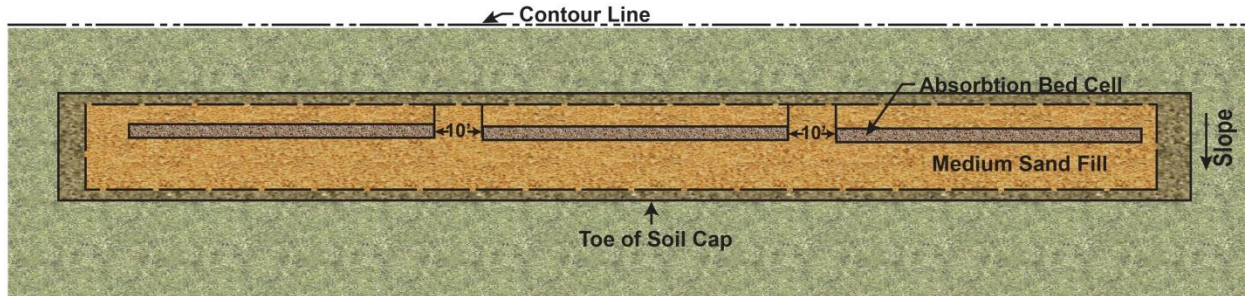

**Figure 4-43. Multiple absorption bed cells installed in one sand mound.**

4. Application rate of effluent in the sand bed should be calculated at 1.0 gallon/ft<sup>2</sup> (sand HAR = 1.0 gallon/ft<sup>2</sup>).
5. Absorption bed must be filled with 9 inches of clean drainrock; 6 inches of which must be below the pressurized distribution pipes.
6. The absorption bed drainrock must be covered with a geotextile after installation and testing of the pressure distribution system.
7. Two observation ports should be installed extending from the drainrock/medium sand interface through the soil cap at approximately the one-quarter and three quarter points along the absorption bed. The observation ports should contain perforations in the side of the pipe extending up 4 inches from the bottom of the port. Observation ports must be capped.
8. Absorption bed disposal area or dimensions may not be reduced through the use of extra drainrock, pretreatment, or gravelless drainfield products.
9. Pressurized laterals within the absorption bed should not be further than 1.5 feet from the absorption bed sidewall and should not be spaced farther than 2.25 feet between each lateral within the absorption bed.
10. Orifice placement should be staggered between neighboring laterals.

#### **4.24.3.2 Medium Sand Fill Design**

1. Mound sand fill must conform to the medium sand definition provided in section 3.2.8.1.2 of this manual.
2. Minimum depth of medium sand below the absorption bed shall be 1 foot.
3. Medium sand fill shall extend out a minimum of 24 inches level from the top edge of the absorption bed on all sides (medium sand fill absorption perimeter), and then uniformly slope as determined by the mound dimensions and the slope limitations described in item 6 below. This is dimension H in Figure 4-44 and Figure 4-45.
4. Flat sites—The effective area will be  $A \times (C+B+D+2(H))$ .
5. Sloped sites—The effective area will be  $A \times (B+D+H)$ .

Equation 4-15 shows the calculation for the absorption bed area.

$$\frac{\text{Design Flow (GPD)}}{\text{Soil Application Rate (GPD/ft}^2\text{)}} \quad \text{Equation 4-15. Effluent application area.}$$

6. Slope of all sides must be 3 horizontal to 1 vertical (3:1) or flatter.
7. Sand fill area must be as long and narrow as practical, with plan view dimension G exceeding dimension F (Figure 4-44).
8. Slope correction factors as provided in Table 4-25 should be used to determine the downslope width of the medium sand fill for sloped sites.
9. Slope correction factors as provided in Table 4-26 should be used to determine the upslope width of the medium sand fill for sloped sites.

**Table 4-25. Downslope correction factors for sloped sites.**

Slope (%)	1	2	3	4	5	6	7	8	9	10	11	12	13	14	15	16	17	18	19	20
Correction Factor	1.03	1.06	1.10	1.14	1.18	1.22	1.27	1.32	1.38	1.44	1.51	1.57	1.64	1.72	1.82	1.92	2.04	2.17	2.33	2.5

**Table 4-26. Upslope correction factors for sloped sites.**

Slope (%)	1	2	3	4	5	6	7	8	9	10	11	12	13	14	15	16	17	18	19	20
Correction Factor	0.97	0.94	0.91	0.89	0.87	0.85	0.83	0.81	0.79	0.77	0.75	0.73	0.72	0.7	0.69	0.67	0.66	0.65	0.64	0.62

Figure 4-44 and Figure 4-45 can be used with Table 4-27 and Table 4-28 (sand mound design checklist) for flat and sloped sites.

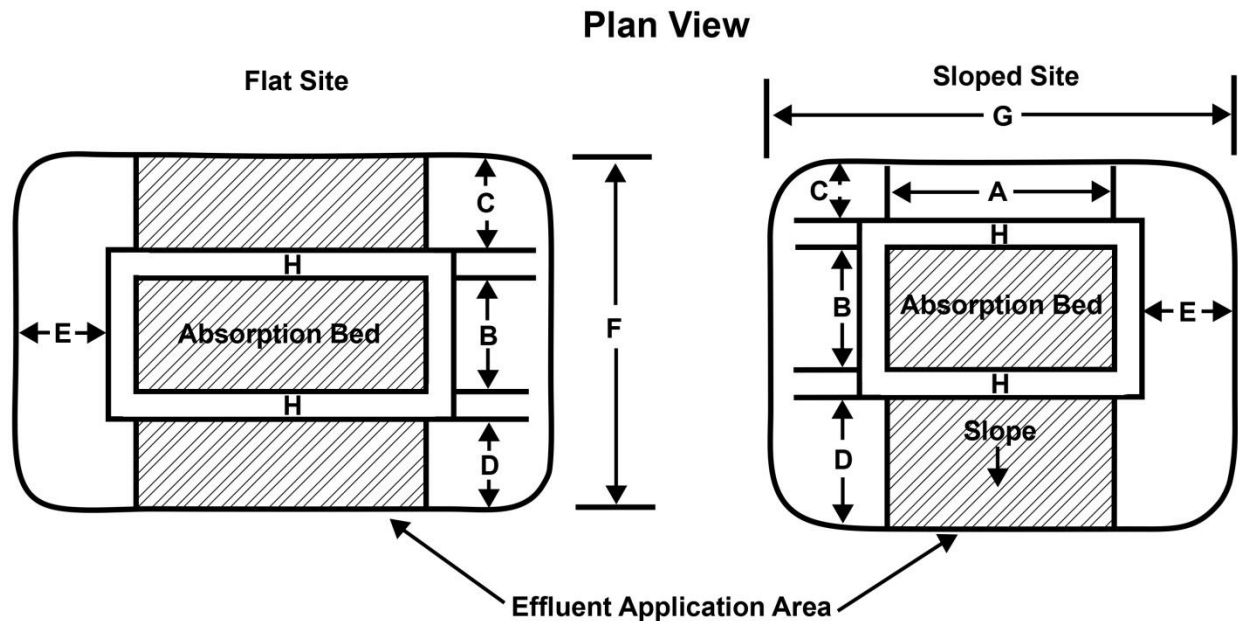

**Figure 4-44. Design illustrations for sand mound installation on flat and sloped sites (use with sand mound design checklist).**

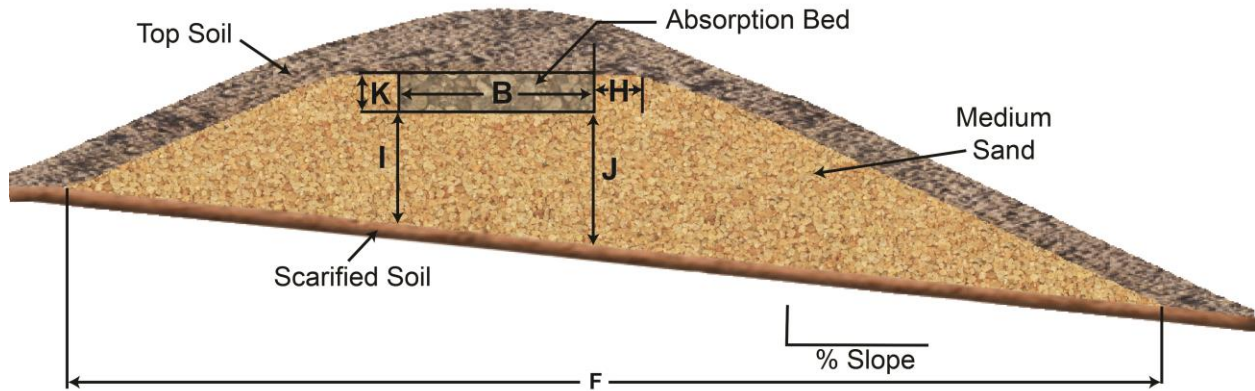

Figure 4-45. Design dimensions for use with the sand mound design checklist.

#### 4.24.3.3 Soil Cap Design

1. Sand mound must be covered with a minimum topsoil depth of 12 inches. The soil cap at the center of the mound must be crowned to 18 inches to promote runoff.
2. Topsoil and soil cap must be a sandy loam, loam, or silt loam. Soils meeting the soil design group classification of A and C shall not be used for the topsoil and soil cap cover.
3. Mound should be protected to prevent damage caused by vehicular, livestock, or excessive pedestrian traffic. The toe of the mound must be protected from compaction.
4. Mounds on slopes should have design considerations taking surface runoff diversion into account.



**Table 4-27. Example sand mound design checklist (use with Table 4-25, Table 4-26, Figure 4-44, and Figure 4-45).**

<b>Sand Mound Design Checklist (Example for a three-bedroom house on soil design subgroup B-2 soils, flat site, 12-inch medium sand fill depth below the absorption bed cell)</b>		
1	Determine soil application rate (AR) (Example: B-2 soil)	AR = GPD/ft <sup>2</sup> (Example: 0.45 GPD/ft <sup>2</sup> )
2	Determine daily flow rate (DFR) (Example: 250 GPD x 1.5 safety factor)	DFR = GPD x 1.5 (Example: 375 GPD)
<b>Absorption Bed Cell Design</b>		
3	$Area = \frac{Daily\_Flow\_Rate\_GPD(\#2)}{Sand\_Application\_Rate\_GPD/ft^2(1.0\_GPD/ft^2)}$	Area = ft <sup>2</sup> (Example: 375 ft <sup>2</sup> )
4	Width (B): $Width\_ (B) = \sqrt{\frac{Area\_ (\#3) \times Soil\_ AR\_ (\#1)}{Sand\_ Application\_ Rate\_ (1.0 GPD/ft^2)}}$ Maximum bed width: 10 ft <i>Beds may be designed narrower than determined by this equation if desired. Beds are recommended to be as long and narrow as site conditions allow.</i>	Width (B) = feet  (Example: 13 ft or 10 ft max.) (Example: use 10 ft)
5	Length (A): $Length\_ (A) = Area\_ (\#3) / Width\_ (\#4)$ (Example: 375 ft <sup>2</sup> /10 ft)	(A) feet (Example: 37.5 ft)
<b>Sand Mound Design</b>		
6	Total area (TA): $TA = DFR\_ (\#2) / soil\_ AR\_ (\#1)$ (Example: 375 gallon/0.45 gallon/ft <sup>2</sup> )	TA = ft <sup>2</sup> (Example: 833 ft <sup>2</sup> )
7	Medium sand fill absorption bed perimeter (SFAP) area: Flat site: SFAP = 2 x [2 ft x length (#5)] Sloped site: SFAP = 2 ft x length (#5) (Example: 2 x [2 ft x 37.5 ft])	SFAP = ft <sup>2</sup>  (Example: 150 ft <sup>2</sup> )
8	Effluent application area (EAA) = Total area – (bed area + SFAP): EAA = TA (#6) – [Area (#3) + SFAP (#7)] = (Flat site example: 833 ft <sup>2</sup> – [375 ft <sup>2</sup> + 150 ft <sup>2</sup> ] = 308 ft <sup>2</sup> ); (Sloped site example: 833 ft <sup>2</sup> – [375 ft <sup>2</sup> + 75 ft <sup>2</sup> ] = 383 ft <sup>2</sup> )	EAA = ft <sup>2</sup> (Flat site example: 308 ft <sup>2</sup> ; sloped site example: 383 ft <sup>2</sup> )

9	<p>Flat site perimeter (C,D): <math>0.5 \times [\text{EAA} (\#8)/\text{length} (\#5)]</math></p> <p><i>Perimeter must maintain a maximum slope of 3:1.</i></p> <p><i>Perimeter width must result in a disposal area that meets or exceeds the minimum total area (#6). This will be verified in step 16.</i></p> <p>(Example: <math>0.5 \times [308 \text{ ft}^2/37.5 \text{ ft}] = 4.1 \text{ ft}</math>)</p>	<p>(C) = (D) = feet (5.25 ft minimum for 3:1 slope in 12 in. mound, 8.25 ft minimum for 3:1 slope in 24 in. mound)</p> <p>(Example: 4.1 ft, use default of 5.25 ft to meet minimum slope)</p>
10	<p>Sloped site: Downslope length (D) = <math>\text{EAA} (\#8)/\text{length} (\#5) \times \text{DCF}</math></p> <p><i>Downslope length must result in a maximum slope of 3:1.</i></p> <p><i>Downslope length must result in a disposal area that meets or exceeds the minimum total area (#6). This will be verified in step 17.</i></p> <p>Example based on 5% slope: (Example: <math>D = [383 \text{ ft}^2/37.5 \text{ ft}] \times 1.18 = 12.1 \text{ ft}</math>)</p>	<p>(D) = feet</p> <p>(Example: 12.1 ft)</p>
11	<p>Sloped site: Upslope (C) = <math>[(K + I) \times 3] \times \text{UCF}</math></p> <p><i>Upslope length must result in a maximum slope of 3:1.</i></p> <p>Example based on 5% slope: (Example: <math>C = [(0.75 \text{ ft} + 1.0 \text{ ft}) \times 3] \times 0.87 = 4.6 \text{ ft}</math>)</p>	<p>(C) = feet</p> <p>(Example: 4.6 ft)</p>
12	<p>Flat site: End slope (E) = <math>(K + I) \times 3</math></p> <p><i>End slope length must result in a maximum slope of 3:1.</i></p> <p>(Example: <math>[0.75 \text{ ft} + 1.0 \text{ ft}] \times [3] = 5.25 \text{ ft}</math>)</p>	<p>(E) = feet</p> <p>(Example: 5.25 ft)</p>
13	<p>Sloped site: End slope (E) = <math>(J + K) \times 3</math></p> <p><i>End slope length must result in a maximum slope of 3:1.</i></p> <p>Example based on 5% slope: (Example: <math>[1.5 \text{ ft} + 0.75 \text{ ft}] \times [3] = 6.75 \text{ ft}</math>)</p>	<p>(E) = feet</p> <p>(Example: 6.75 ft)</p>
14	<p>Total width (F) = <math>B + C + D + 2(H)</math></p> <p>(Flat site example: <math>10 \text{ ft} + 5.25 \text{ ft} + 5.25 \text{ ft} + 4 \text{ ft} = 24.5 \text{ ft}</math>)</p> <p>(Sloped site example (5%): <math>10 \text{ ft} + 4.6 \text{ ft} + 12.1 \text{ ft} + 4 \text{ ft} = 30.7 \text{ ft}</math>)</p>	<p>(F) = feet</p> <p>(Example: 24.5 ft)</p> <p>(Example: 30.7 ft)</p>
15	<p>Total length (G) = <math>A + (2 \times E) + 2(H)</math> (G &gt; F)</p> <p>(Flat site example: <math>[G] = 37.5 \text{ ft} + [2 \times 5.25 \text{ ft}] + 4 \text{ ft} = 52 \text{ ft}</math>)</p> <p>(Sloped site example (5%): <math>[G] = 37.5 \text{ ft} + [2 \times 6.75 \text{ ft}] + 4 \text{ ft} = 55 \text{ ft}</math>)</p>	<p>(G) = feet</p> <p>(Example: 52 ft)</p> <p>(Example: 55 ft)</p>

<b>Total Area Verification</b>		
16	Flat site: Design area (DA) = A x F [ DA ≥ TA(#6)]  (Example: [37.5 ft x 24.5 ft] = 918.75 ft <sup>2</sup> ; (918.75 ft <sup>2</sup> ≥ 833 ft <sup>2</sup> )	DA = ft <sup>2</sup>  Example: 919 ft <sup>2</sup>
17	Sloped site: Design area (DA) = A x (B + D + H) [DA ≥ TA(#6)]  (Example (5%): 37.5 ft x [10 ft + 12.1 ft + 2 ft] = 903.75 ft <sup>2</sup> ; (903.75 ft <sup>2</sup> ≥ 833 ft <sup>2</sup> )	DA = ft <sup>2</sup>  Example: 903.75 ft <sup>2</sup>
<b>Finished Mound Dimensions (Sand Mound + Soil Cap)</b>		
18	Sand mound length + 6 ft min. (G + 6)  (Flat site example: 52 ft + 6 ft = 58 ft)  (Sloped site example: 55 ft + 6 ft = 61 ft)	(G+6) = feet  (Example: 58 ft)  (Example: 61 ft)
19	Sand mound width + 6 ft min. (F + 6)  (Flat site example: 24.5 ft + 6 ft = 30.5 ft)  (Sloped site example: 30.7 ft + 6 ft = 36.7 ft)	(F+6) = feet  (Example: 30.5 ft)  (Example: 36.7 ft)

*Notes:* gallons per day per square foot (GPD/ft<sup>2</sup>), feet (ft), inches (in.), downslope correction factor (DCF), upslope correction factor (UCF), total area (TA), design area (DA), effluent application area (EAA), sand fill absorption perimeter (SFAP), daily flow rate (DFR), soil application rate (AR)

#### 4.24.4 Construction

1. Pressure transport line from the dosing chamber should be installed first.
  - a. The pressure transport line should slope down to the pump so that the pressure line will drain between discharges.
  - b. If a downward slope from the mound to the pump chamber is not practical due to the length of run, then the pressure transport line should be laid level below the anticipated frost line for that region.
  - c. On a sloped site, the pressure transport line should enter the absorption bed from the end of the bed or upslope side of the mound; do not enter the absorption bed from the downslope side.
2. Grass and shrubs must be cut close to ground surface and removed from the mound site.
  - a. If extremely heavy vegetation or organic mat exists, these materials should be removed before scarification and replaced with filter sand (typically 3 or 4 inches of filter sand is added).
  - b. Larger than 2-inch caliper trees and shrubs and large boulders are not to be removed. Trees should be cut as close to ground level as possible and the stumps left in place. If stumps or boulders occupy a significant area in the mound placement area, additional area should be calculated into the total basal area of the mound to compensate for the lost infiltrative area.
3. When the soil is dry and site vegetation has been cut or removed, the ground in the basal placement area of the sand mound should be scarified using a chisel plow or backhoe teeth to a depth of 6–8 inches.

4. Sand fill will then be placed and shaped before it freezes or rains. No vehicles with pneumatic tires should be permitted on the sand or scarified area to prevent the soils from being compacted. For sloped sites, all work should be done from the upslope side or ends of the mound placement area if possible.
5. Absorption bed will be shaped and filled with clean drainrock. The bottom of the absorption bed should be constructed level on all sites regardless of slope.
6. After leveling the drainrock, the low-pressure distribution system manifold and laterals will be installed. The system should be tested for uniformity of distribution.
7. Geotextile fabric must be placed over the absorption bed and backfilled with 12 inches of soil on the sides and shoulders, and 18 inches of soil on the top center. Soil types must be sandy loam, loam, or silt loam.
8. Typical lawn grasses or other appropriate low-profile vegetation should be established on the mound cap as soon as possible, preferably before the system is put into operation. Do not plant trees or shrubs on the mound, or within the mature rooting radius of the tree or shrub from the mound. Trees with roots that aggressively seek water should be planted at least 50 feet from the mound (e.g., poplar, willow, cottonwood, maple, and elm).
9. Mounds placed upslope and downslope from each other should maintain a mound-toe to mound-toe separation distance of 35 feet (Figure 4-46).
  - a. The first 15 feet below the upslope mound should remain free of vehicular traffic and other activities resulting in soil compaction.
  - b. The 20 feet above the downslope mound should be maintained for construction of the downslope mound.
10. A separation distance of 15 feet should be maintained from the toe of each mound when multiple mounds are constructed on the same elevation contour.

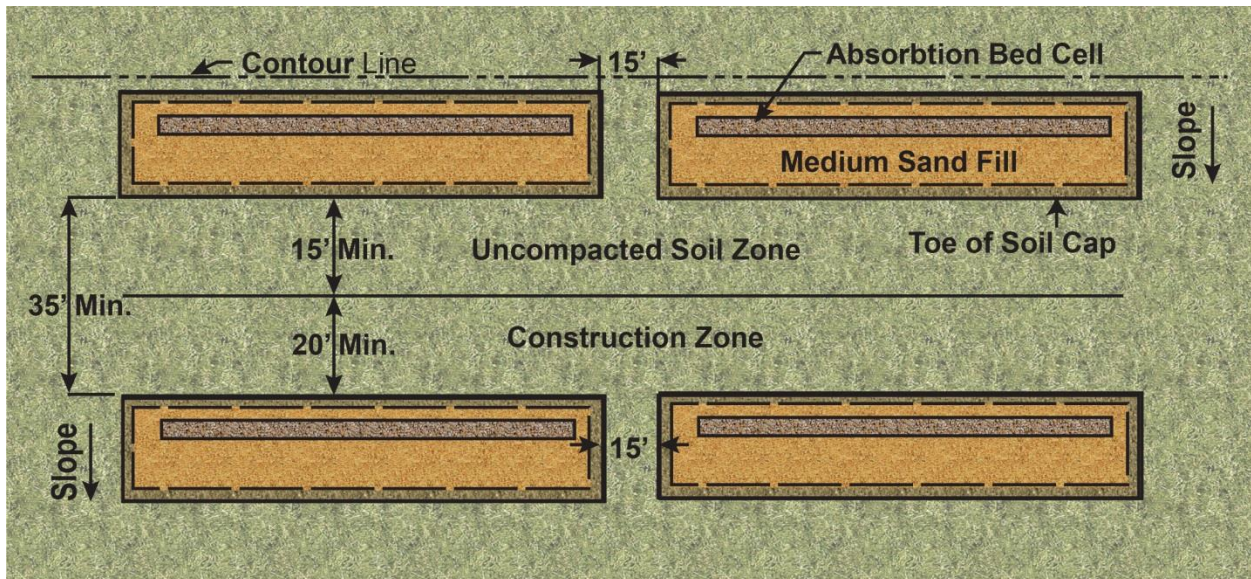

Figure 4-46. Mounds placed upslope and downslope of one another.

#### 4.24.5 Inspections

1. Site inspections shall be conducted by the health district at the following minimum intervals (IDAPA 58.01.03.011.01):
  - a. Preconstruction conference that should be conducted with the health district, responsible charge engineer, complex installer, and property owner (if available) present.
  - b. During construction as needed, including scarification, pressure line installation, medium sand mound construction, absorption bed construction, and pressure distribution piping construction.
  - c. Final construction inspection including a pump drawdown/alarm check, pressure test of the distribution network, and soil cap material and placement.
2. The responsible charge engineer shall provide the health district with a written statement that the system was constructed and functions in compliance with the approved plans and specifications. Additionally, the responsible charge engineer shall provide as-built plans to the health district if any construction deviations occur from the permitted construction plans (IDAPA 58.01.03.005.15).

#### 4.24.6 Operation and Maintenance

An O&M manual shall be developed by the system’s design engineer that contains the following minimum requirements and shall be submitted as part of the permit application (IDAPA 58.01.03.005.14):

1. Operation and maintenance is the responsibility of the system owner.
2. Sludge depth in the septic tank should be checked annually and the tank should be pumped when the sludge exceeds 40% of the liquid depth.
3. All pump and pump chamber alarm floats and controls should be inspected on a regular schedule to ensure proper function.
4. Pump screens and effluent filters should be inspected regularly and cleaned. All material created by cleaning the screen should be discharged to the septic tank.
5. Sand mound observation port caps should be removed and the monitoring ports observed for ponding. Corrective action should be taken, if excessive ponding is present, as specified by the system design engineer.
6. Observation ports for testing of residual head should be inspected regularly to ensure the residual head meets the system design minimum residual head.
7. Lateral flushing should occur annually to ensure any biomat buildup is removed from the distribution lateral. Lateral flushing procedures should be described.
8. On a regular schedule, any valving for sand mounds containing multiple absorption bed cells should be inspected and verified to be functioning properly.
9. Any other operation and maintenance as recommended by system component manufacturers and the system design engineer.

Table 4-27 is a sample sand mound design checklist, and Table 4-28 is a blank checklist for sand mound design.

**Table 4-28. Sand mound design checklist (use with Table 4-25, Table 4-26, Figure 4-44, and Figure 4-45).**

<b>Sand Mound Design Checklist</b>		
1	Determine soil application rate (AR)	AR = _____ GPD/ft <sup>2</sup>
2	Determine daily flow rate (DFR) $DFR = GPD \times 1.5$	DFR = _____ GPD
<b>Absorption Bed Cell Design</b>		
3	$Area = \frac{Daily\_Flow\_Rate\_GPD(\#2)}{Sand\_Application\_Rate\_GPD/ft^2 \left(1.0 \frac{GPD}{ft^2}\right)}$	Area = _____ ft <sup>2</sup>
4	Width (B): $Width\_ (B) = \sqrt{\frac{Area\_ (\#3) \times Soil\_ AR\_ (\#1)}{Sand\_ Application\_ Rate\_ \left(1.0 \frac{GPD}{ft^2}\right)}}$ Maximum bed width: 10 ft	Width (B) = _____ ft
5	Length (A): $Length\_ (A) = Area\_ (\#3) / Width\_ (\#4)$	(A) _____ ft
<b>Sand Mound Design</b>		
6	Total area (TA): $EAA = DFR\_ (\#2) / soil\_ AR\_ (\#1)$	TA = _____ ft <sup>2</sup>
7	Medium sand fill perimeter area (SFAP) Flat site: SFAP = 2 x [2 ft x length (#5)] Sloped site: SFAP = 2 ft x length (#5)	SFAP = _____ ft <sup>2</sup>
8	Effluent application area (EAA) = Total area – (Bed area + SFAP): $EAA = TA (\#6) - [Area (\#3) + SFAP (\#7)]$	EAA = _____ ft <sup>2</sup>
9	Flat site perimeter (C,D): 0.5 x [EAA (#8)/length (#5)] (5.25 ft minimum for 12 in. mound, 8.25 ft minimum for 24 in. mound)	(C) = (D) = _____ ft
10	Sloped site: Downslope length (D) = [EAA (#8)/length (#5)] x DCF	(D) = _____ ft
11	Sloped site: Upslope (C) = [(K + I) x 3] x UCF	(C) = _____ ft
12	Flat site: End slope (E) = (K + I) x 3	(E) = _____ ft
13	Sloped site: End slope (E) = (J + K) x 3	(E) = _____ ft
14	Total width (F) = B + C + D + 2(H)	(F) = _____ ft
15	Total length (G) = A + (2 x E) + 2(H) (G > F)	(G) = _____ ft
<b>Total Area Verification</b>		
16	Flat site: Design area (DA) = A x F [DA ≥ TA(#6)]	DA = _____ ft <sup>2</sup> ≥ #6
17	Sloped site: Design area (DA) = A x (B + D + H) [DA ≥ TA(#6)]	DA = _____ ft <sup>2</sup> ≥ #6
<b>Finished Mound Dimensions (Sand Mound + Soil Cap)</b>		
18	Sand mound length + 6 ft min. (G + 6)	(G+6) = _____ ft
19	Sand mound width + 6 ft min. (F + 6)	(F+6) = _____ ft

*Notes:* gallons per day per square foot (GPD/ft<sup>2</sup>), feet (ft), downslope correction factor (DCF), upslope correction factor (UCF), total area (TA), design area (DA), effluent application area (EAA), sand fill absorption perimeter (SFAP), daily flow rate (DFR), soil application rate (AR)

## 4.25 Seepage Pit/Bed

Revision: April 18, 2013

Installer registration permit: Property owner or standard and basic

Licensed professional engineer required: No

### 4.25.1 Description

An absorption pit filled with standard drainfield aggregate.

### 4.25.2 Approval Conditions

1. Seepage pit disposal facilities may be used on a case-by-case basis within the boundaries of Eastern Idaho Public Health District (District Health Department 7) when an applicant can demonstrate to the district director's satisfaction that the soils and depth to ground water are sufficient to prevent ground water contamination. The district director shall document all such cases (IDAPA 58.01.03.008.11).
  - a. For all other districts, replacement seepage pits may be allowable as a last resort if no other alternatives are feasible, and the site meets conditions of approval 1.a through 6 as stated herein. The district director shall document all such cases (IDAPA 58.01.03.008.11) and issue the installation permit as a nonconforming permit.
2. For all other districts, the site must meet the requirements of a standard system except that it is not large enough (IDAPA 58.01.03.008.11.b).
3. Area must not have any shallow domestic, public wells, or sink holes connected by underground channels.
4. Pit bottom must be no deeper than 18 feet below the natural ground surface. The bottom of the pit must conform to the effective soil depth chart (IDAPA 58.01.03.008.02.c). *The top of the pit may be more than 4 feet below ground surface.*
5. Seepage pits may not be installed in design group C soils.
6. A test hole must be performed to a depth of 6 feet below the proposed termination of the bottom of the seepage pit prior to permit issuance.

### 4.25.3 Sizing

The effective area of the pit may be determined from Table 4-29 (for round pits) and by the square footage of the pit sidewalls below the effluent pipe (rectangular beds).

Seepage bed example:

Pit dimensions are 10 feet wide x 15 feet long, and the pit is 8 feet deep below the effluent pipe:

$$(10 \text{ feet wide}) \times (8 \text{ feet deep}) = 80 \text{ ft}^2 \rightarrow (80 \text{ ft}^2) \times (2 \text{ sidewalls of the same dimension}) = 160 \text{ ft}^2$$

(15 feet wide) x (8 feet deep) = 120 ft<sup>2</sup> → (120 ft<sup>2</sup>) x (2 sidewalls of the same dimension) = 240 ft<sup>2</sup>

(240 ft<sup>2</sup>) + (160 ft<sup>2</sup>) = 400 ft<sup>2</sup>

Round seepage pit example:

$$(\pi d) \times h = \text{effective disposal area}$$

d = diameter, h = height,  $\pi = 3.14$

**Table 4-29. Effective area of round seepage pits.**

Diameter of Seepage Pit (feet)	Effective Depth Below Effluent Line (feet)									
	1	2	3	4	5	6	7	8	9	10
3	9	19	28	38	47	57	66	75	85	94
4	13	25	38	50	63	75	88	101	113	126
5	16	31	47	63	79	94	110	126	141	157
6	19	38	57	75	94	113	132	151	170	188
7	22	44	66	88	110	132	154	176	198	220
8	25	50	75	101	126	151	176	201	226	251
9	28	57	85	113	141	170	198	226	254	283
10	31	63	94	126	157	188	220	251	283	314
11	35	69	104	138	173	207	242	276	311	346
12	38	75	113	151	188	226	264	302	339	377

#### 4.25.4 Construction

1. Standard drainfield aggregate shall be used to fill the entire pit/bed excavation.
  - a. If seepage pit rings or structural blocks are used in pit/bed construction the aggregate shall only be required to fill the excavation void around the seepage rings or structural blocks and above the seepage ring lid to a point 2 inches above the effluent pipe.
  - b. In pit/bed installations using seepage pit rings a minimum depth of 12 inches of standard drainfield aggregate shall be placed below the seepage rings.
2. Effluent pipe shall be covered with a minimum of 2 inches of aggregate.
3. Seepage pit/bed excavation shall be covered with geotextile, straw, or untreated building paper.
4. The distribution laterals within the pit/bed should meet the requirements for the standard absorption bed (IDAPA 58.01.03.008.10).



5. If seepage pit rings or structural blocks are used in pit/bed construction the effluent pipe may discharge into the central dump point in the ring structure lid.
6. Effluent and distribution piping used in seepage pit/beds with installation depths greater than 3 feet from grade to the top of the pit/bed installation shall utilize ASTM D3034 or stronger piping to prevent piping collapse.

## 4.26 Steep Slope System

Revision: December 10, 2014

Installer registration permit: Property owner or standard and basic

Licensed professional engineer required: No

### 4.26.1 Description

A steep slope system is a trench system for slopes greater than 20% but less than 46%.

### 4.26.2 Approval Conditions

1. Soil must be well-drained without evidence of saturation and of soil design group A or B without evidence of textural change in the effective depth.
2. Except as listed in this section, all regulations applicable to a standard system will apply.
3. Trenches must be separated by at least 8 horizontal feet of undisturbed soil.
4. Trenches may not exceed 36 inches in width.
5. The drainfield bottom must be installed at a minimum depth of 30 inches below the natural soil surface on the downhill side of the trench:
  - a. The drainfield bottom may not exceed 48 inches below the natural soil surface on the downhill side of the trench.
  - b. The required vertical separation distances from the bottom of the drainfield to features of interest (IDAPA 58.01.03.008.02.c) must be capable of being met from the uphill side of the drainfield trench.
6. A gravel drainfield must meet the following:
  - a. Contain a minimum of 18 inches of drainrock, 12 inches of which must be installed below the perforated distribution pipe.
  - b. Restriction on the credit for the installation of extra drainrock below the drainfield in the steep slope system shall follow section 4.9.
7. A gravelless drainfield must meet the following:
  - a. Be constructed with an approved gravelless trench component (section 4.11) configuration.
  - b. No reduction in drainfield disposal area shall be credited for the installation of the gravelless trench component in the steep slope system.

### 4.26.3 Construction

1. Trenches may be constructed using serial or equal distribution.
  - a. Pressure distribution is recommended but not required.
  - b. If serial distribution is used, it is recommended that the system is constructed using drop boxes (section 3.2.6.2).
  - c. If equal distribution is used, it is highly recommended that a distribution box (section 3.2.5.2) be utilized, access to the distribution box from grade be available, and equal flow to each trench be verified before backfilling the system.

2. Regardless of the distribution method used, the drainfield trenches should follow the natural contour of the land surface.
3. In consideration of safety and plumb trench sidewalls, hand excavation of trenches may be necessary.
4. Figure 4-47 illustrates the relationship between the site's vertical drop and horizontal run.

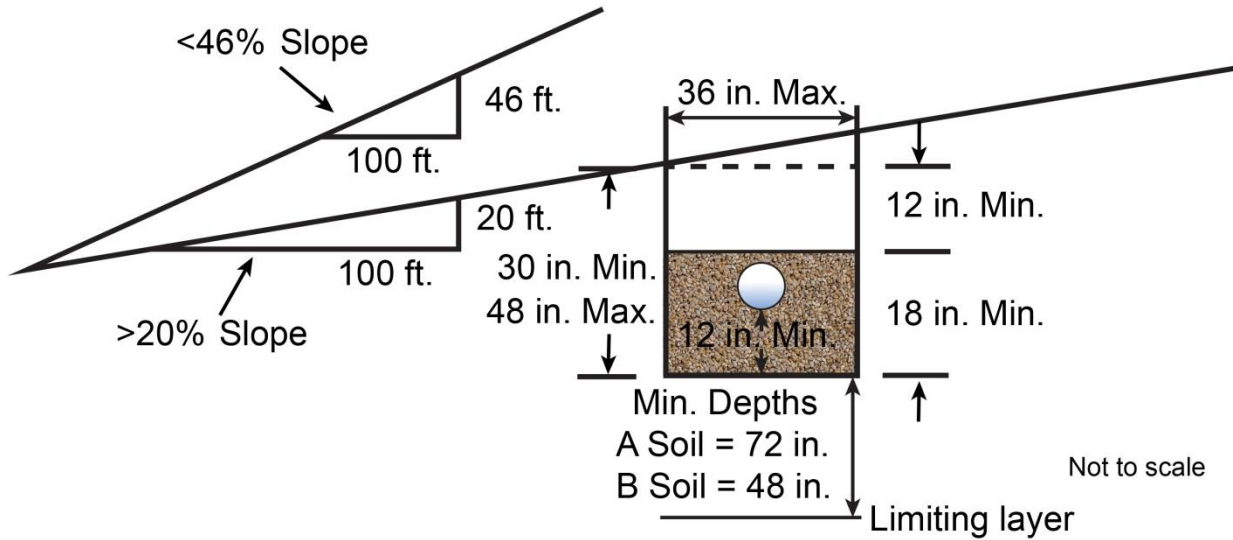

**Figure 4-47. Illustration of a steep slope trench with an example of maximum and minimum slope.**

Equation 4-16 shows the calculation for determining a site's percent slope.

$$\frac{\text{Elevation Difference from Uphill Point to Downhill Point (Rise)}}{\text{Length Between Uphill and Downhill Point (Run)}} \times 100$$

**Equation 4-16. Percent slope of a site.**

## 4.27 Subsurface Flow Constructed Wetland

Revision: February 4, 2016

Installer registration permit: Complex

Licensed professional engineer required: Yes

### 4.27.1 Description

Subsurface flow constructed wetlands are secondary wastewater treatment systems that receive and treat wastewater that has undergone primary treatment in a septic tank. Wastewater flows through a lined, constructed wetland cell filled with porous media in which climate and anaerobic, water-tolerant vegetation is planted. The vegetation provides uptake of the wastewater and a surface for microorganisms to grow, which aid in wastewater treatment. Wastewater exits the horizontally constructed wetland cell, proceeds to a watertight overflow basin, and either discharges to another constructed wetland cell in series with the first, or to a subsurface sewage disposal drainfield. Figure 4-48 provides a diagram of a subsurface flow constructed wetland.

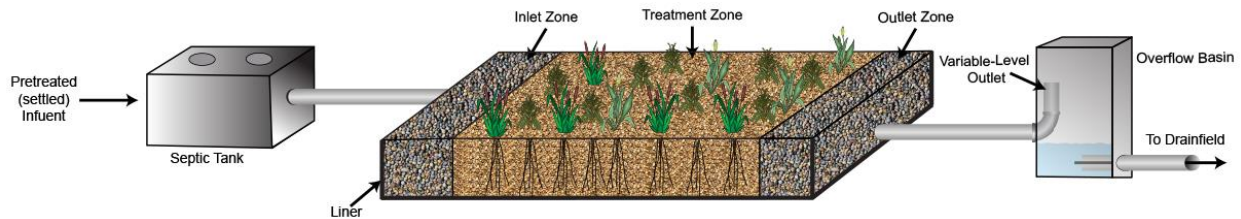

Figure 4-48. Cross-sectional view of a subsurface flow constructed wetland.

### 4.27.2 Approval Conditions

1. The system must be designed by a PE licensed in Idaho.
2. Wastewater must remain below the ground surface in the constructed wetland.
3. Nondomestic wastewater must be pretreated to residential strength before discharge to the constructed wetland.
4. Effluent shall not discharge to the drainfield without first passing through the constructed wetland.
5. The bottom of the constructed wetland must not come within 12 inches of seasonal high ground water.
6. The constructed wetland shall meet the same separation distance requirements as a septic tank.
7. The design engineer shall provide an O&M manual for the system to the health district before permit issuance.
8. All pressure distribution components shall be designed according to the pressure distribution system guidance (section 4.19).

### 4.27.3 Design Requirements

Minimum design requirements for the subsurface flow constructed wetland are provided below.

**4.27.3.1 Septic Tank**

1. Shall be sized according to the requirements of IDAPA 58.01.03.007.07.
2. Shall have an approved effluent filter (section 5.8) installed at the outlet.
3. The outlet manhole shall be brought to grade using a riser and secured lid to provide maintenance access to the effluent filter.

**4.27.3.2 Effluent Transport to the Subsurface Flow Constructed Wetland**

1. Gravity flow is the preferred method to transport wastewater from the septic tank to the subsurface flow constructed wetland.
2. If gravity flow is not possible a dosing chamber may be installed meeting the requirements of section 4.19.3.4, and the effluent shall break to gravity following the requirements of section 4.19.3.6 before entering the subsurface flow constructed wetland.
3. If the installation of a pump-to-gravity distribution component is necessary, the drop box shall be accessible from grade for maintenance purposes.
4. Pressurized doses shall have a small volume so the subsurface flow constructed wetland does not receive large surge flows.

**4.27.3.3 Subsurface Flow Constructed Wetland**

1. The subsurface flow constructed wetland container shall be constructed of reinforced concrete or other materials where equivalent function, workmanship, watertightness, and at least a 20-year service life can be documented, or
2. The subsurface flow constructed wetland container shall be constructed of a flexible membrane liner meeting the following requirements:
  - a. Properties equivalent to or greater than 30-mil PVC and compatible with wastewater.
  - b. Field repair instructions and materials provided to the purchaser of the liner.
  - c. Factory fabricated boots for waterproof field bonding of piping to the liner.
  - d. Liner must be placed against smooth, regular surfaces free of sharp edges, nails, wire, splinters, or other objects that may puncture the liner. A 4-inch layer of clean sand should provide liner protection.
3. The subsurface flow constructed wetland shall have a berm that is at least 1 foot above the surface of the planting media with sides that are as steep as possible, consistent with the soils, construction methods, and materials.
4. Filter construction media shall meet the following specifications:
  - a. Section 3.2.8.1.3 for planting media (pea gravel)
  - b. Section 3.2.8.1.1 for inlet and outlet zone media (drainrock)
  - c. Treatment zone media shall have an average diameter between 0.75 and 1 inch and be free of fines.
5. The surface of the subsurface flow constructed wetland shall be level.

6. The bottom of the subsurface flow constructed wetland shall maintain a uniform slope from the inlet to the outlet of 0.5% to 1% to maintain flow conditions and allow for complete drainage.
7. Minimum filter construction specifications shall also meet the dimensions, ratios, and locations depicted in Figure 4-49.
8. The inlet and outlet zones should be designed to prevent accidental contact with effluent from the surface. Chain-link fencing or another acceptable protective barrier shall be placed below the construction media at the top of the inlet/outlet zones and cover the entire surface of the inlet and outlet areas to prevent access, unless fencing is placed around the entire system to prevent access.

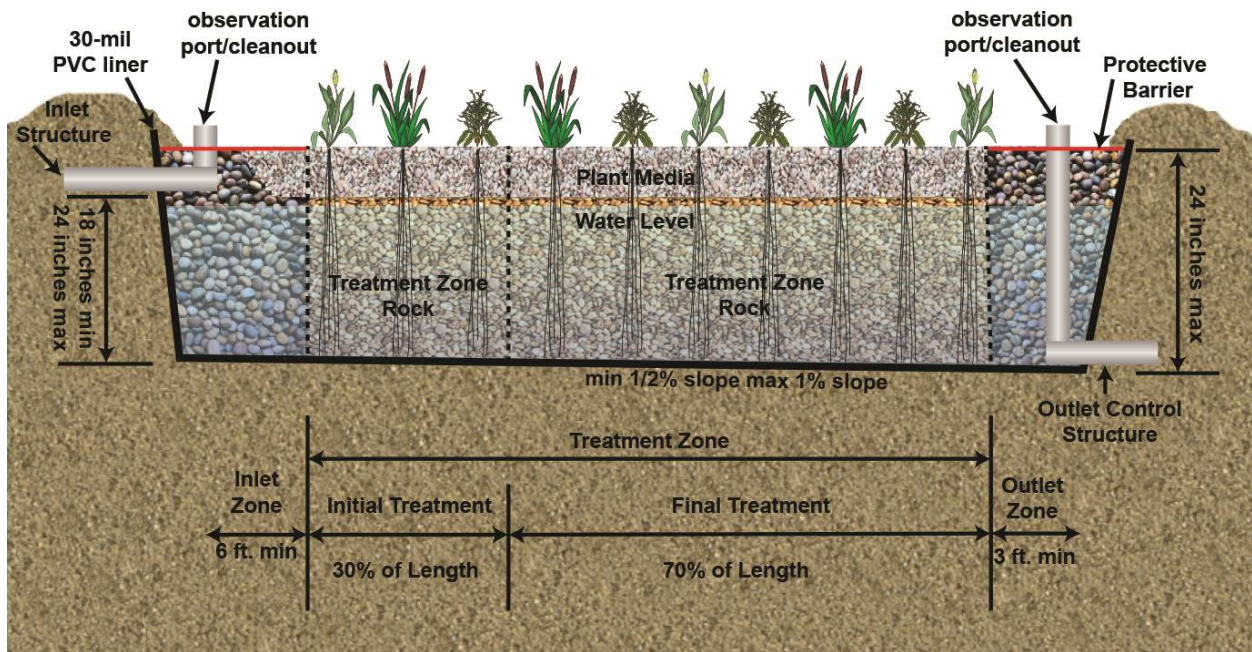

Figure 4-49. Cross-sectional view of a constructed wetland cell.

#### 4.27.3.4 Subsurface Flow Constructed Wetland Sizing

Sizing of a subsurface flow constructed wetland must take into account the loading of BOD and TSS from the wastewater. In addition the treatment zone of the subsurface flow constructed wetland should be capable of maintaining a hydraulic retention time of at least 2 days. Use correctly size the wetland. with the information provided below to correctly size the wetland.

1. Determine the minimum treatment zone surface area for both pollutants (BOD and TSS) and use the largest area (Equation 4-17).
  - a. BOD surface area:  $A_{SB} = (Q)(B)/(53.5 \text{ lb/acre/day})$
  - b. TSS surface area:  $A_{ST} = (Q)(T)/(44.5 \text{ lb/acre/day})$

**Equation 4-17. BOD and TSS surface area in square feet.**

where:

$A_{SB}$  and  $A_{ST}$  = total surface area of the treatment zone in square feet ( $ft^2$ ) for BOD ( $A_{SB}$ ) and TSS ( $A_{ST}$ ).

$Q$  = total daily design flow in gallons per day (gal/day).

$B$  = 0.0018 lb/gal (constant value for the maximum BOD discharged to the system per gallon).

$T$  = 0.00071 lb/gal (constant value for the maximum TSS discharged to the system per gallon).

**Example:**

$$A_{SB} = (250 \text{ GPD})(0.0018 \text{ lb/gal}) / (53.5 \text{ lb/acre/day}) = 0.0084 \text{ acres}$$

$$(0.0084 \text{ acres})(43,560 \text{ ft}^2/\text{acre}) = 366 \text{ ft}^2$$

$$A_{ST} = (250 \text{ GPD})(0.00071 \text{ lb/gal}) / (44.5 \text{ lb/acre/day}) = 0.004 \text{ acres}$$

$$(0.004 \text{ acres})(43,560 \text{ ft}^2/\text{acre}) = 175 \text{ ft}^2$$

$$\text{Use } A_{SB} = 366 \text{ ft}^2$$

2. Apply a 25% safety factor to the required size of the treatment zone.

**Example:**

$$(366 \text{ ft}^2)(1.25) = 458 \text{ ft}^2$$

3. Determine the size of the initial treatment zone and final treatment zone within the total treatment zone using the following requirements:

- a. Initial treatment zone = 30% of the overall treatment zone area

**Example:**

$$A_{IT} = 0.3(458 \text{ ft}^2) = 138 \text{ ft}^2$$

- b. Final treatment zone = 70% of the overall treatment zone area

**Example:**

$$A_{FT} = 0.7(458 \text{ ft}^2) = 321 \text{ ft}^2$$

4. The hydraulic conductivity ( $K$ ) of clean treatment zone media meeting the sizing requirements in section 4.27.3.3(4) is 30,500 ft/day. Due to filtration and settling of materials, the hydraulic conductivity of the treatment zone is as follows:
  - a. Initial treatment zone is 1% of the clean  $K$ , or 305 ft/day.
  - b. Final treatment zone is 10% of clean  $K$ , or 3,050 ft/day.
5. Determine the minimum width based on the hydraulic loading rates that will maintain all flow below the surface of the submerged flow constructed wetland using Darcy's Law (Equation 4-18). The largest width should be used for the overall system design.

$$Q = KWD_w(d_r/L)$$

**Equation 4-18. Darcy's Law**

where:

$L$  = length of treatment zone = area/width; therefore:

$$W^2 = (QA_{si}) / (KD_w d_h)$$

where:

$A_{si}$  = surface area of the treatment zone (ft<sup>2</sup>)

$D_w$  = depth of water (ft)

$W$  = width of cell (ft)

$Q$  = flow into cell (ft<sup>3</sup>/day) (1 ft<sup>3</sup> = 7.48052 gal)

$K$  = hydraulic conductivity (ft/day)

$d_h$  = maximum permissible headloss (ft) (assume = 50% of difference between depth of media and depth of water)

**Example:**

$$\text{Initial Treatment Zone} = W^2 = [(33.42)(458 \text{ ft}^2)] / [(305 \text{ ft/day})(1.33 \text{ ft})(0.167 \text{ ft})] = (15306.36 \text{ ft}^2) / (67.74 \text{ ft}) = 226 \text{ ft} \rightarrow (\sqrt{226}) = 15 \text{ ft}$$

$$\text{Final Treatment Zone} = W^2 = [(33.42)(458 \text{ ft}^2)] / [(3050 \text{ ft/day})(1.33 \text{ ft})(0.167 \text{ ft})] = (15306.36 \text{ ft}^2) / (677.4 \text{ ft}) = 22.6 \text{ ft} \rightarrow (\sqrt{22.6}) = 4.8 \text{ ft}$$

Use 15 ft for both treatment zone widths.

- Determine the maximum length of each treatment zone by dividing the required treatment area by the width (Equation 4-19).

$$L_{IT} = (0.3 A_T) / W$$

**Equation 4-19. Initial treatment zone length.**

where:

$L_{IT}$  = total length of the initial treatment zone

$A_T$  = total required treatment area

$W$  = width (determined in step 5)

0.3 = constant (described in step 3)

**Example:**

$$L_{IT} = [(0.3)(458 \text{ ft}^2)] / (15 \text{ ft}) = 9.2 \text{ ft} \rightarrow \text{use } 10 \text{ ft (Equation 4-20).}$$

$$L_{FT} = (0.7 A_T) / W$$

**Equation 4-20. Final treatment zone length.**

where:

$L_{FT}$  = total length of the final treatment zone

$A_T$  = total required treatment area

$W$  = width (determined in step 5)

0.7 = constant (described in step 3)

**Example:**

$$L_{IT} = [(0.7)(458 \text{ ft}^2)] / (15 \text{ ft}) = 21.4 \text{ ft} \rightarrow \text{use } 22 \text{ ft}$$

- Verify that the total treatment zone has a hydraulic retention time of at least 2 days assuming a porosity of the treatment media of 30% and that the length-to-width ratio of the submerged flow constructed wetland (inlet zone, total treatment zone, and outlet zone) is 3:1 or less. If the hydraulic retention time and/or the length-to-width ratio of the system do not meet the requirements above, adjust the system dimensions to meet



the requirements while maintaining the minimum treatment area and minimum width required (Equation 4-21).

$$\text{HRT} = (L_{\text{TZ}}W_{\text{TZ}}(1.33)(0.3))/Q \quad \text{Equation 4-21. Hydraulic retention time.}$$

where:

HRT = hydraulic retention time

$L_{\text{TZ}}$  = length of the total treatment zone

$W_{\text{TZ}}$  = width of the treatment zone

1.33 = depth of the water level within the submerged flow constructed wetland at normal operating level

0.3 = porosity of the treatment zone media

7.48052 = gallons per cubic foot

Q = total daily design flow

**Example:**

$$\text{HRT} = [(41 \text{ ft})(15 \text{ ft})(1.33 \text{ ft})(0.3)(7.48052 \text{ gal/ft}^3)]/(250 \text{ GPD}) = (1835.6 \text{ gal})/(250 \text{ GPD}) = 7.34 \text{ days (Equation 4-22).}$$

$$L:W = (L_{\text{TZ}}+L_{\text{IZ}}+L_{\text{OZ}})/W_{\text{TZ}} \quad \text{Equation 4-22. Length-to-width ratio of the subsurface flow constructed wetland.}$$

where:

L:W = length-to-width ratio

$L_{\text{TZ}}$  = length of the treatment zone

$L_{\text{IZ}}$  = length of the inlet zone

$L_{\text{OZ}}$  = length of the outlet zone

$W_{\text{TZ}}$  = width of the treatment zone

**Example:**

$$L:W = (32 \text{ ft}+6 \text{ ft}+3 \text{ ft})/15 \text{ ft} = 41 \text{ ft}/15 \text{ ft} = 2.73/1$$

Table 4-30 provides the subsurface flow constructed wetland sizing checklist. Use this checklist with items 1–7 above to correctly size the wetland.

**Table 4-30. Subsurface flow constructed wetland sizing checklist.**

<b>Treatment Zone Surface Area</b>		
1	Determine daily design flow (Q)	Q = _____ GPD
2	Determine the treatment zone surface area based on BOD and TSS $A_{SB} = [(Q)(0.0018 \text{ lb/gal})]/(53.5 \text{ lb/acre/day})$ ; and $A_{ST} = [(Q)(0.00071 \text{ lb/gal})]/(44.5 \text{ lb/acre/day})$ Convert acreage to square feet and add safety factor using $[(\text{Acres})(43560 \text{ ft}^2/\text{acre})(1.25)] = \text{ft}^2$	$A_{SB} = \text{_____ ft}^2$ $A_{ST} = \text{_____ ft}^2$ Use largest value (A)
<b>Initial Treatment Zone and Final Treatment Zone</b>		
3	Determine the size of the initial treatment zone $A_{IT} = 0.3 (A)$	Initial Treatment Zone = _____ $\text{ft}^2$ (B)
4	Determine the size of the final treatment zone $A_{FT} = 0.7(A)$	Final Treatment Zone = _____ $\text{ft}^2$ (C)
5	Determine the minimum width of the treatment zones  $W^2 = (QA_{Si})/(KD_w d_h)$  Round up to nearest foot	Initial Treatment Zone Width = _____ ft   Final Treatment Zone Width = _____ ft  Use largest value (D)
6	Determine the maximum length of the initial treatment zone $L_{IT} = (B)/(D)$ Round up to nearest foot	Maximum Length of the Initial Treatment Zone Length = _____ ft (E)
7	Determine the maximum length of the final treatment zone $L_{FT} = (C)/(D)$ Round up to nearest foot	Maximum Length of the Final Treatment Zone Length = _____ ft (F)
<b>Retention Time</b>		
8	Verify the total treatment zone has a hydraulic retention time of at least 2 days $HRT = (L_{TZ}W_{TZ}(1.33)(0.3))/Q$	Hydraulic Retention Time = _____ days
<b>Length-to-Width Ratio</b>		
9	Verify that the length-to-width ratio of the wetland is 3:1 or less $L:W = ((E+F)+L_{IZ}+L_{OZ})/D$	Length-to-Width Ratio = _____

Notes: gallons per day (GPD); pounds per gallon (lb/gal); pounds per acre per day (lb/acre/day); square feet per acre ( $\text{ft}^2/\text{acre}$ ); square feet ( $\text{ft}^2$ ); feet (ft)

**4.27.3.5 Subsurface Flow Constructed Wetland Cells**

1. Subsurface flow constructed wetlands may be divided into multiple cells in series to maintain length-to-width ratios (Figure 4-50).
2. Subsurface flow wetlands shall be divided into multiple parallel trains that contain one or more cells as described in Table 4-31.
3. For wetlands with daily design flows of 2,500 gallons per day or more, piping shall be included in the design that allows each cell to be taken off line and bypassed for maintenance and repair needs.
4. Daily flows must be divided equally among each train.
5. Each subsurface flow constructed wetland cell shall contain its own watertight overflow basin as described in section 4.27.3.6.

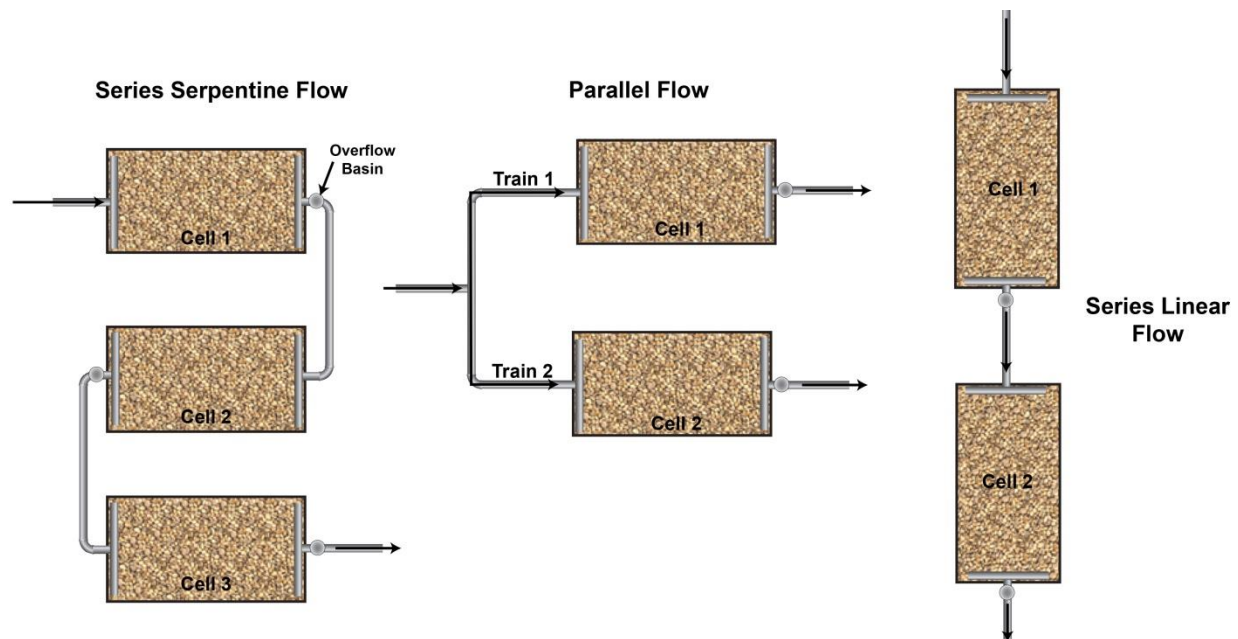

Figure 4-50. Configuration of wetland cells in series and parallel.

Table 4-31. Required subsurface flow constructed wetland trains and cells based on daily design flow.

Daily Design Flow (GPD)	Minimum Number of Trains	Minimum Number of Cells per Train	Minimum Number of Cells
<2,500	1	1	1
2,500–4,999	2	2	4
≥5,000	4	2	8

Note: gallons per day (GPD)

#### **4.27.3.6 Inlet and Outlet Structures in the Subsurface Flow Constructed Wetland**

1. The inlet control structure should uniformly distribute the inflow across the entire width of the constructed wetland (Figure 4-51).
2. The inlet and outlet piping and control structures shall have a minimum diameter of 4 inches.
3. The inlet and outlet control structures shall have cleanouts that are accessible from grade.
4. The inlet control structure shall be located at the top of the drainrock in the inlet zone, be located as close to the inlet wall of the wetland as possible, and be level across its entire length.
5. Orifices on the inlet and outlet control structures should be evenly spaced with a maximum distance between orifices equal to 10% of the wetland width.
6. The outlet control structure should uniformly collect wastewater effluent across the entire width of the wetland.
7. The outlet control structure shall be located at the bottom of the drainrock in the outlet zone, be located as close to the outlet wall of the wetland as possible, and be level across its entire length.
8. The outlet control structure shall discharge to a watertight overflow basin located outside of the constructed wetland.
9. The watertight overflow basin (Figure 4-52) shall have the following:
  - a. Minimum diameter of 20 inches and be accessible from grade.
  - b. Water level control device that allows the operator to flood the constructed wetland to a point that is level with the surface of the planting media, completely drain the constructed wetland, and maintain the water level within the constructed wetland anywhere in between these two points and maintain a 2-day hydraulic retention time. *Note: Normal operating level is located 4 inches below the surface of the treatment media.*
  - c. Gravity flow to the drainfield. If gravity flow is not achievable and/or pressurization of the drainfield or transport piping is necessary, then the watertight basin must be an approved dosing chamber or septic tank that meets the requirements of section 4.19.3.4.

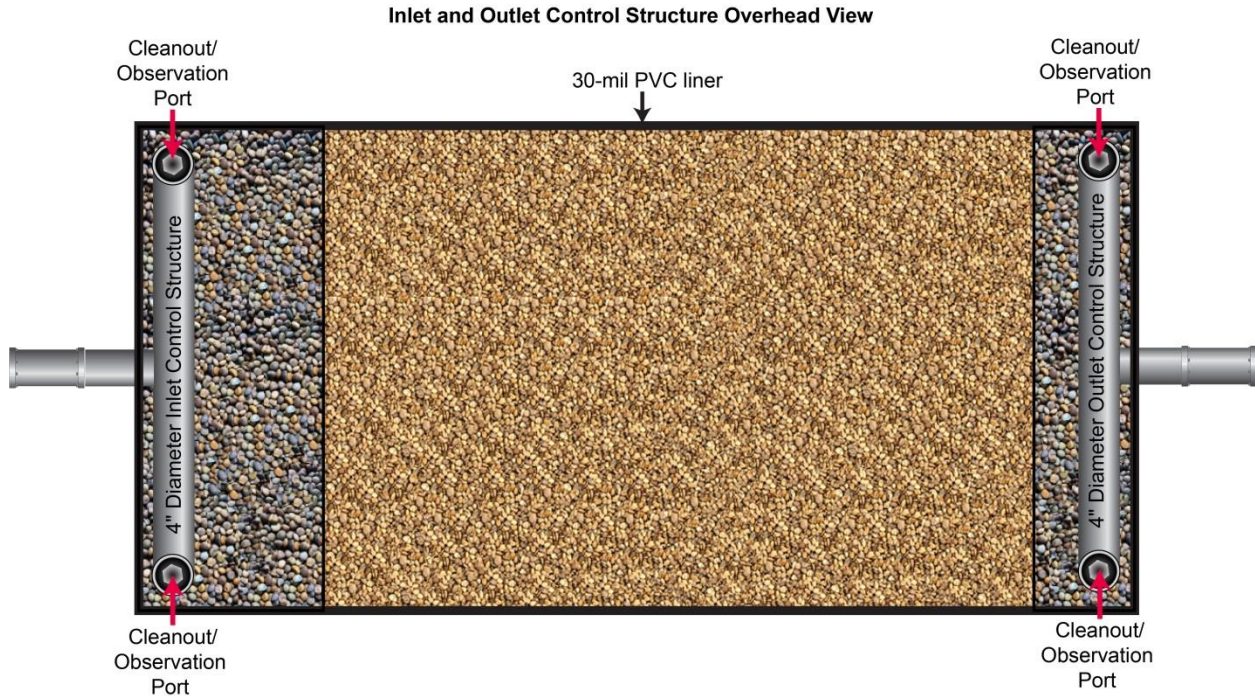

**Figure 4-51. Overhead view of a wetland showing the inlet and outlet control structures in relation to the wetland width.**

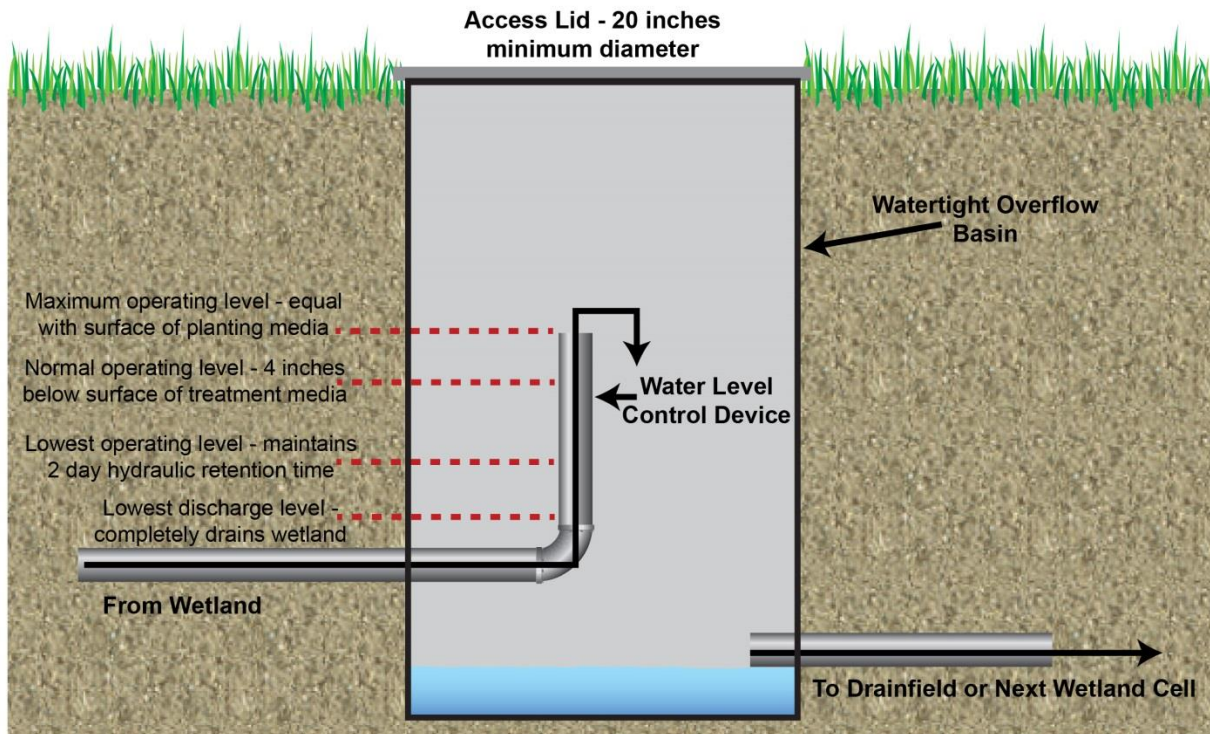

**Figure 4-52. Cross-sectional view of an overflow basin.**

#### 4.27.3.7 Subsurface Flow Constructed Wetlands Vegetation

1. Planting densities shall be 1–2 feet on center in staggered rows throughout the treatment zone of the wetland (Figure 4-53).
2. Vegetation should not be established within the inlet and outlet zones of the wetland.
3. Vegetation shall not be established from seed.
4. Plant species requirements:
  - a. Capable of producing root depths that will extend to the bottom of the wetland (20 inches)
  - b. Tolerant of local climates and continuous submersion of their roots in anaerobic water
  - c. No noxious or invasive plants
  - d. No flowering or soft tissue plants that decompose rapidly
  - e. No emergent woody plants or riparian trees and shrubs
  - f. No submerged or floating aquatic plants
  - g. Recommended species include, but are not limited to, the following:
    - 1) Alkali bulrush (*Schoenoplectus maritimus*)
    - 2) Baltic rush (*Juncus balticus*)
    - 3) Broadleaf cattail (*Typha latifolia*)
    - 4) Creeping spikerush (*Eleocharis palustris*)
    - 5) Hardstem bulrush (*Schoenoplectus acutus*)
    - 6) Nebraska sedge (*Carex nebrascensis*)
5. Plants should be allowed to establish for up to 6 weeks before wastewater is discharged to the wetland. Raise the water level in the wetland to the top of the planting media. After rooting establishment, lower the water level in the wetland to the normal operating depth of 4 inches below the treatment media surface.
6. To promote plant growth and enhance root development, lower the water level within the wetland on an annual basis from the normal operating level to a level that is equivalent to a 2-day hydraulic retention time within the treatment zone. The water level should be lowered and raised back to a normal operational level over several weeks.

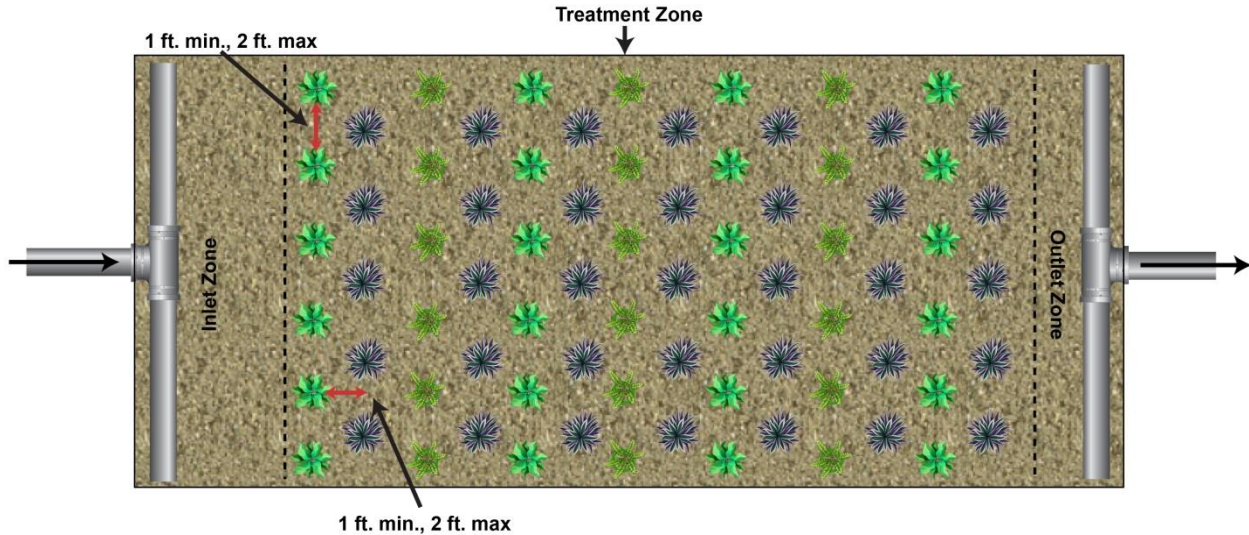

Figure 4-53. Vegetation and planting spacing throughout the wetland treatment zone.

#### 4.27.3.8 Subsurface Flow Constructed Wetlands Temperature Protection

1. Temperature protection of the subsurface flow constructed wetlands and its components should be taken into consideration by the design engineer.
2. Several inches ( $\geq 6$  inches) of insulating mulch or peat should be placed on a layer of geotextile fabric that covers the surface of the planting media.
3. Plants should not be cut back before the nongrowing season.

#### 4.27.4 Submerged Flow Constructed Wetlands Construction

1. All vegetation in the placement area of the wetlands should be cleared and grubbed to remove large roots and stumps. Large rocks should also be removed.
2. All soil used in constructing the wetland bottom and berm shall be compacted to at least 95% standard Proctor density.
3. When grading and constructing a wetland cell, do not create low spots or preferred flows down a particular side of the wetland that will encourage short circuiting.
4. After grading and compaction, construction equipment should not enter the constructed wetland cell.
5. If used, the flexible liner containment system shall be constructed on top of a protective layer of sand. The protective layer of sand shall consist of a 4-inch layer of clean sand placed, graded, and compacted to match the wetland slope requirements on the compacted native grade.
  - a. The liner should be installed according to the manufacturer's recommendations and extend to a height of 12 inches above the treatment media and located within the containment berm at all locations above the planting media.
  - b. A geotextile fabric with a weight of 4 ounces should be placed over the liner before placing media in the constructed cell.
6. All media should be washed on site before placement in the constructed cell.

### 4.27.5 Drainfield Trenches

1. Distances shown in Table 4-32 must be maintained between the trench bottom and limiting layer.
2. Capping fill may be used to obtain adequate separation distance from limiting layers must be designed and constructed according to the guidance for capping fill trenches in section 4.3.
3. Pressure distribution may be used with the following design considerations:
  - a. The pressure distribution system related to the drainfield is designed according to section 4.19.
  - b. The dosing chamber for the drainfield trenches may be substituted for the overflow basin from the constructed wetland cell.
4. The drainfield shall be sized by dividing the maximum daily flow by the hydraulic application rate for the applicable soil design subgroup listed in Table 4-33.

**Table 4-32. Submerged flow constructed wetland vertical separation distance to limiting layers (feet).**

Limiting Layer	Flow < 2,500 GPD	Flow ≥ 2,500 GPD
	All Soil Types	All Soil Types
Impermeable layer	2	4
Fractured rock or very porous layer	1	2
Normal high ground water	1	2
Seasonal high ground water	1	2

Note: gallons per day (GPD)

**Table 4-33. Secondary biological treatment system hydraulic application rates.**

Soil Design Subgroup	Application Rate (gallons/square foot/day)
A-1	1.7
A-2a	1.2
A-2b	1.0
B-1	0.8
B-2	0.6
C-1	0.4
C-2	0.3

### 4.27.6 Inspection

1. A preconstruction meeting between the health district, responsible charge engineer, and installer should occur before commencing any construction activities.
2. The site must be inspected when the wetland cell has been excavated and formed and before installing the containment structure. Compaction test results for all fill materials, containment berms, and the wetland bottom shall be provided at this time.



3. The health district should inspect all system components before backfilling and inspect the filter container construction before filling with drainrock and treatment construction media.
4. The responsible charge engineer shall conduct as many inspections as needed to verify system component compliance with the engineered plans.
5. The responsible charge engineer shall provide the health district with a written statement that the system was constructed and functions in compliance with the approved plans and specifications. Additionally, the responsible charge engineer shall provide as-built plans to the health district if any construction deviations occur from the permitted construction plans (IDAPA 58.01.03.005.15).

#### **4.27.7 Operation and Maintenance**

1. The subsurface flow constructed wetland design engineer shall provide a copy of the system's OMM procedures to the health district as part of the permit application and before subsurface sewage disposal permit issuance (IDAPA 58.01.03.005.04.k).
2. Fertilizing the system is not required.
3. System irrigation is not required.
4. Systems with multiple cells must have directions on how each cell may be isolated so repair work can be performed without additional wastewater entering the cell.
5. Periodic surface maintenance may be required for any of the following reasons:
  - a. In the spring, the thick layer of leaves and any other organic material that has been built up on the system surface should be removed and disposed of with other yard refuse. Some wetland plants may require trimming but should not be cut back or harvested.
  - b. In the summer, if the surface contains weeds, they should be removed and disposed of with other yard refuse. Some wetland plants may require trimming but should not be cut back or harvested.
  - c. Autumn maintenance may include gently spreading leaves over the surface and/or replacing the thick layer of mulch or peat over the system. Wetland plants should not be cut back or harvested. Wetland plants and a thick layer of leaves will provide a thermal blanket that will help prevent the system from freezing during the winter.
  - d. All woody or fibrous plant starts (e.g., tree saplings and bushes) should be removed any time they are noticed as they may result in damage to the wetland cells or liners.
6. Inspection/maintenance schedule and instructions for the constructed wetland cell(s), septic tank, inlet and outlet control devices, overflow basin, and any mechanical parts associated with system design.
7. Methods to address odors if they become noticeable.
8. Methods to address burrowing animals if they become a problem in or around the wetland cell.
9. A plan to address freezing issues that may arise during colder months. Suggestions include placing a thick layer of mulch or peat over the wetland cell, placing a thick

layer of leaves over the wetland cell, temporarily raising and then lowering the water level within the wetland cell after the top water level has frozen.

10. Operation and maintenance directions should be included describing the replacement of the wetland cell media and informing the system owner that a repair permit must be obtained from the health district for this activity.
11. Vegetation management instructions should be included for vegetation start-up, harvesting (if necessary), and replacement. Vegetation sourcing information should also be included.

## 4.28 Two-Cell Infiltrative System

Revision: December 10, 2014

Installer registration permit: Complex

Licensed professional engineer required: No

### 4.28.1 Description

Domestic sewage is discharged into a two-cell infiltrative system (TCIS). The cells provide sewage storage during wet seasons. The second cell provides very slow infiltration into the surrounding soils. Evaporation and more rapid infiltration occur during dry seasons, reducing the liquid volume and replenishing the cell's storage capacity.

### 4.28.2 Approval Conditions

1. Cells may not be placed within 100 feet of the owner's property line and may not be placed within 300 feet from a neighboring dwelling.
2. Bottom of the finished cells must meet the effective soil depths for a design group C soil.
3. Soil design group must be C or *unsuitable clays*.
4. Site must be located in an area of maximum exposure to the sun and wind.
5. Slope must not be greater than 6%.
6. System cannot be placed on fill.
7. Source of make-up water with a backflow prevention system between the source and TCIS must be readily available.
8. Lot size shall be at least 5 acres.
9. This design is for an individual residential dwelling with up to six bedrooms and is not to be used for commercial or industrial nondomestic wastewater.
10. In areas of Idaho where the precipitation exceeds evaporation by more than 6 inches, this design would be considered experimental.
11. A reserve area equal to the size of the second cell shall be required.

### 4.28.3 Design Requirements

1. The first cell is approximately 32,100 gallons at a liquid depth of 4 feet and should operate full or nearly full at all times.
2. If the water level of the first cell drops below 2 feet, make-up water is added to raise the water level up to the 2-foot minimum pool.
3. The second cell is approximately 51,000 gallons at a liquid depth of 4 feet, which provides 182 days or about 6 months of storage when this cell is dry.
4. Total minimum volume of both cells combined is 83,100 gallons at a liquid depth of 4 feet.

#### 4.28.4 Construction

1. Shallow permeable topsoils shall be removed before starting excavation and construction (topsoils may be saved and used to provide vegetative cover on the dike embankments).
2. Dike levees, embankments, and inlet piping trenches shall be compacted to 95% standard proctor density.
3. No vehicles with pneumatic tires shall be permitted on the basal area or inside slope of the second cell.
4. Sewage discharge inlet must be placed in the center of the basal area of both cells.
5. Concrete splash pad must be constructed around the discharge inlets.
6. Water depth gauges clearly visible from the edge of both cells shall be installed.
7. Cleanout must be placed on the gravity effluent lines at a point above the maximum liquid elevation.
8. If the sewage is pumped to the system, a check valve and shutoff valve must be placed between the pump and system so that repairs can be completed without draining the cells.
9. Excavation must provide the following dike and embankment details:
  - a. Inner slope – 3:1
  - b. Outer slope – 2:1 or flatter
  - c. Embankment width – 4 feet minimum
10. System must be fenced to exclude children, pets, and livestock. A sign on the fence indicating *Danger—Human Sewage* shall be erected.
11. Diversion ditches or curtain drains must be installed on sloping terrain to prevent surface runoff from entering the system.
12. Before operation of the system, the first cell shall be filled with 2 feet of make-up water.
13. Top and outer embankment shall be seeded or adequately protected from erosion.

#### 4.28.5 Inspection

1. A preconstruction conference should be held between the health district and installer.
2. Site must be inspected at the time the cells are excavated.
3. All required system components and design elements shall be inspected.
4. Inspection is required during embankment construction to verify that all fill material is compacted to 95% proctor density.
5. Prior to operation and before filling the first cell with make-up water, a final inspection shall be completed.

#### 4.28.6 Operation and Maintenance

1. The first cell must be kept filled with at least 2 feet of liquid.
2. Annual maintenance and testing of the backflow prevention device installed on the make-up water supply line shall be performed at least annually and completed according to the manufacturer's recommendations.

3. Permanent vegetation should be maintained on the top and outer slopes of the embankment except where a foot or vehicle path is in use.
4. Woody vegetation should be removed from the embankments, grasses should be mowed, and other vegetation should not be allowed to grow in either of the cells.
5. Floating aquatic weeds must be physically removed on a regular basis.
6. The fence and all gates surrounding the system must be maintained to exclude animals, children, and other unwanted intrusion.

Figure 4-54 shows a cross-sectional view of a TCIS. Figure 4-55 provides an overhead view of a TCIS.

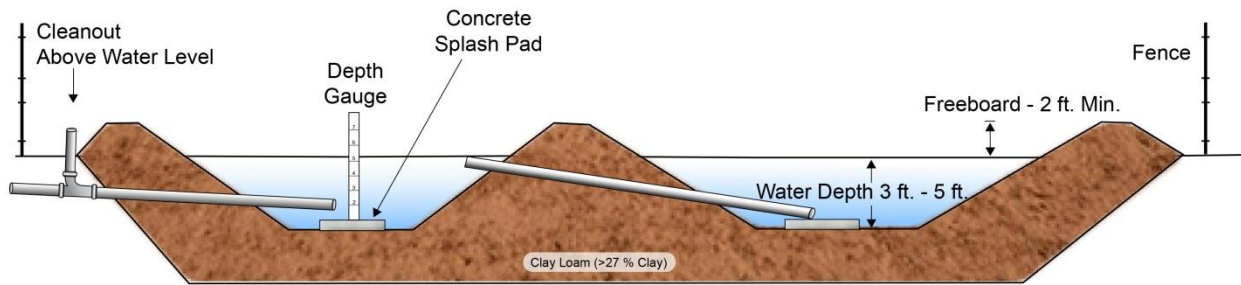

Figure 4-54. Cross-sectional view of a two-cell infiltrative system.

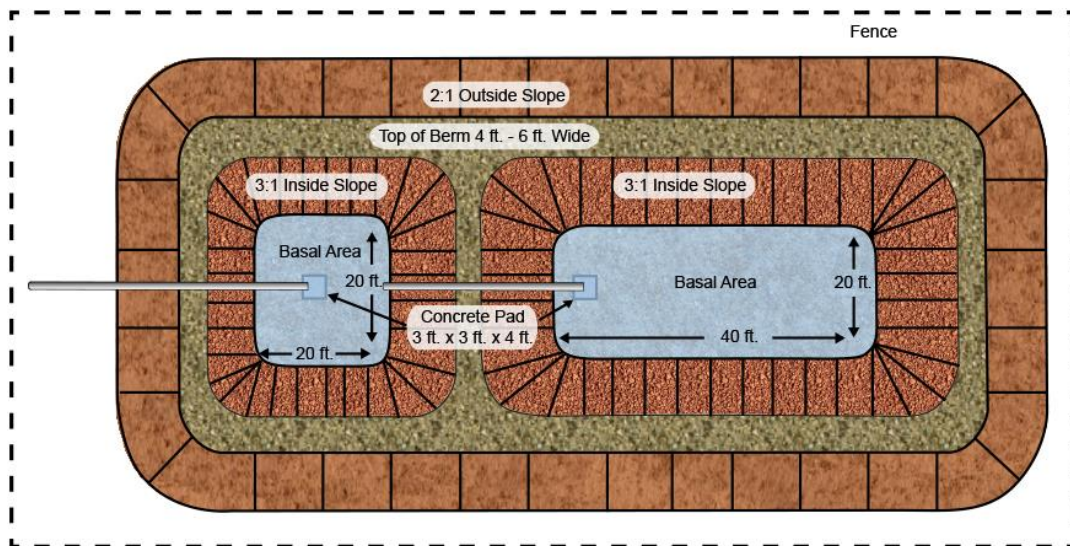

Figure 4-55. Overhead view of a two-cell infiltrative system.

## 4.29 Vault Privy

Revision: March 20, 2015

Installer registration permit: Property owner or standard and basic

Licensed professional engineer required: No

### 4.29.1 Description

A vault privy is a sealed underground vault for the temporary storage of nonwater-carried sewage. The vault is pumped periodically by a permitted pumper and the sewage disposed of at an approved disposal site.

### 4.29.2 Approval Conditions

1. Surface water will be excluded.
2. Vault privies should not be located in floodways.
3. The privy vault must meet the separation distance requirements of a septic tank (IDAPA 58.01.03.007.17).
4. Structures on the property served by water under pressure shall install a subsurface sewage disposal system, and the structure shall not discharge to the vault.
5. Vault privy must be accessible for maintenance.
6. The vault must be an approved septic tank (section 5.2) or vault toilet (section 5.10).
7. The vault vent stack is recommended to be on the south side of the roof where practical.
8. The vault must be pumped by an Idaho-permitted septic tank pumper.
9. The building and toilet structures over the privy vault shall meet the same requirements of structures and toilets over pit privies (section 4.17) except the vent stack shall be on the outside of the vault structure.

### 4.29.3 Design Requirements

1. Privy vault must be watertight, constructed of durable materials, and not subject to excessive corrosion, decay, frost damage, or cracking.
2. Vault may be a modified septic tank with inlet and outlet openings sealed or a preapproved vault unit.
3. The volume of the vault tank must be 375 gallons for each toilet, except that no tank may be less than 500 gallons.
4. The vault shall be vented to the outside of the building with a black, screened (maximum screen size of 16-mesh) vent stack that has a minimum diameter of 3 inches per seat and extends at least 12 inches above the roof of the building.
5. An access pumping port (manhole) shall be located outside of any vault structure, have a minimum diameter equivalent to the diameter of the toilet opening, and have a secured cover that prevents the escape to gases, odors, and prevents unauthorized access.
6. The area where the vault is placed must be
  - a. Firm and level for at least 12 inches from the sides of the top of the vault.

- b. Shall be at least 12 inches above the highest ground elevation as measured 18 inches from the sides of the building.
- c. Shall be graded at a maximum slope of 3:1 starting 18 inches from the sides of the top of the vault.

## 4.30 Drainfield Remediation Components

Revision: October 25, 2011

Installer registration permit: Complex

Licensed professional engineer required: No

### 4.30.1 Description

Drainfield remediation components (DRC) are manufactured and *packaged* mechanical treatment devices designed to aid in restoring single-family dwelling drainfields that are biologically failing. Such devices may promote the biological breakdown of excessive buildup to the biological mat (biomat) in the absorption area. They consist of a self-contained drop-in unit that includes an aeration device, and they may or may not incorporate the use of proprietary bacteria and growth media. Installers must obtain an installation permit before installing a DRC, pursuant to IDAPA 58.01.03.005 (section 7.1).

### 4.30.2 Approval Conditions

1. A permit may be issued for a DRC only in approved, permitted systems, or systems that were installed before permitting requirements were established. In the absence of a permit, a site investigation may be needed to determine suitability for this type of component. If the site is not suitable for a DRC, then the sewage on ground protocol (section 6.1) shall be followed, and a repair permit shall be issued for a new drainfield to replace the failed drainfield.
2. Candidates for DRC installation are gravity drainfields that are failing due to excessive biomat growth. A single-family dwelling with gravity drainfields and system inspection is recommended to verify that the drainfield is not malfunctioning due to excessive hydraulic loading (e.g., leaking toilets, faucets, or high-occupancy rates), or soil structural changes due to use of an ion exchange water softener.
3. A DRC unit will be selected from the approved DRC listing in section 5.11. A PE licensed in Idaho, specializing in sanitary or environmental engineering, may design a drainfield remediation component and submit it for use under the experimental system section in this manual (section 4.7).
4. A manufacturer's checklist, warranty, and operations and maintenance instructions must be part of the permit application as specified in IDAPA 58.01.03.005.04.o (section 7.1) and become part of the permit upon permit approval. A record of component installation shall be provided to the health district before final approval of the permit and will become part of the final permit.
5. Once the DRC is installed, it must remain as part of the system unless removal is approved pursuant to IDAPA 58.01.03.005.01 (section 7.1).
6. The following statement shall be placed on the permit:  
The health district is permitting this component for installation into an existing system and does not guarantee that it will remediate the failing system. If the component fails to adequately remediate the system, the owner may be required to take further measures to repair or replace the system. The health district shall be held harmless if the component fails to achieve the manufacturer's claims.



### 4.30.3 Construction

1. Installer shall confirm the integrity of the tank and system by pumping and inspecting the septic tank before installing a DRC.
2. Component shall be installed by an Idaho-licensed complex installer.
3. Install components according to manufacturer's specifications.
4. All electrical work shall be inspected and must be approved by the state's electrical inspector.
5. Install access risers above grade for maintenance and to provide drainage away from the riser. The riser diameter shall comply with IDAPA 58.01.03.007.13 (section 7.1), at a minimum. Diameter's larger than this 20-inch minimum may be needed to provide ongoing maintenance, install bundled units, and allow for replacement or removal of the DRC and any accessory components associated with the unit.
6. Install an effluent filter (section 5.8), or equivalent, in the outlet baffle before discharging effluent to the drainfield.
7. Inspection ports at the d-box or terminus of the drainfield may be required so that the remediation progress can be measured.
8. An audible and/or visual high-water alarm is recommended.

### 4.30.4 Operation

The DRC is expected to abate the public health threat of sewage on the ground and all other indications of biomat failure within 30 days of installation. If evidence of biomat failure persists and no significant remediation has occurred after 30 days, the system may be considered a failed system, and the property owner will be required to obtain a repair permit for a replacement drainfield and complete the installation of the new drainfield.

Table 5-15 provides a list of DRC.

### 4.31 References

EPA (United States Environmental Protection Agency). 2002. *Onsite Wastewater Treatment Systems Manual*. Washington, DC: EPA. EPA/625/R-00/008.

Otis, R.J. 1981. *Design of Pressure Distribution Networks for Septic-Tank Absorption Systems*. Madison, WI: Small Scale Waste Management Project Publication #9.6.

Rice, E.W., R.B. Baird, A.D. Eaton, and L.S. Clesceri. 2012. *Standard Methods for the Examination of Water and Wastewater*. Washington, DC: American Public Health Association.

## 5 Approved Installers, Pumpers, and Components

### 5.1 Approved Installers and Pumpers

Revision: February 4, 2016

Because of continual changes in the status of installers and pumpers state-wide, their listing in the TGM will no longer occur. To determine if an installer or pumper is licensed, or to receive a current list of local installers or local septic tank pumpers, contact the following health districts.

Panhandle Health District 8500 N. Atlas Rd. Hayden, ID 83835 (208) 415-5200	Counties: Benewah, Bonner, Boundary, Kootenai, Shoshone
Public Health – Idaho North Central District 215 10th Street Lewiston, ID 83501 (208) 799-3100	Counties: Clearwater, Idaho, Latah, Lewis, Nez Perce
Southwest District Health 13307 Miami Ln. Caldwell, ID 83607 (208) 455-5400	Counties: Adams, Canyon, Gem, Owyhee, Payette, Washington
Central District Health Department 707 N. Armstrong Place Boise, ID 83704 (208) 327-7499	Counties: Ada, Boise, Elmore, Valley
South Central Public Health District 1020 Washington St. North Twin Falls, ID 83301 (208) 737-5900	Counties: Blaine, Camas, Cassia, Gooding, Jerome, Lincoln, Minidoka, Twin Falls
Southeastern Idaho Public Health 1901 Alvin Ricken Drive Pocatello, ID 83201 (208) 239-5270	Counties: Bannock, Bear Lake, Bingham, Butte, Caribou, Franklin, Oneida, Power
Eastern Idaho Public Health 1250 Hollipark Drive Idaho Falls, ID 83401 (208) 523-5382	Counties: Bonneville, Clark, Custer, Fremont, Jefferson, Lemhi, Madison, Teton
Idaho Department of Environmental Quality 1410 N. Hilton Boise, ID 83706 (208) 373-0140	

## 5.2 Approved Septic Tanks

Revision: March 24, 2020

Table 5-1 lists septic tanks approved for use by DEQ.

**Table 5-1. Approved septic tanks.**

Septic Tank Manufacturer	Unit Liquid Volume (gallons)	Maximum Bury Depth (feet)	Tank Description (material, number of compartments, number of pieces, uses)	Approval Date (month/day/year)
<b>Anderson Supply</b> 630 E. Cottonwood Bozeman, MT 59715	1,000	3	Concrete, single compartment, one piece	9/13/88
	1,000, 1,500	3	Concrete, two compartment, <sup>a</sup> one piece	9/13/88
	2,000	3	Concrete, two compartment, <sup>a</sup> one piece	9/13/88
	1,500	3	Concrete, two-compartment, one-piece, 1,000-gallon septic tank + 500-gallon dosing chamber or 1,500-gallon septic tank	9/13/88
<b>Atkinson Septic Tanks</b> 1315 W. Idaho Blvd. Emmett, ID 83617 (208) 870-4326	1,150	3	Concrete, three-compartment, two-piece, Jet Inc. ETPS tank	11/16/95
<b>Bonner Concrete Products, Inc.</b> P.O. Box 321 Sagle, ID 83860 (208) 263-3979	1,000, 1,250, 1,500	3	Concrete, single compartment, two piece, 1,000-gallon low profile septic tank	12/12/84
	1,000	3	Concrete, single compartment, one piece	5/22/18
	1,500	3	Concrete, single compartment, one piece	7/5/06
	1,500 + 500	3	Concrete, two-compartment, one-piece, 1,500-gallon septic tank with integral 500-gallon dosing chamber only	6/27/06
	2,000	3	Concrete, single compartment, one piece	6/27/06
	1,500	3	Concrete, two-compartment, one-piece, 1,000-gallon septic tank + 500-gallon dosing chamber or 1,500-gallon septic tank	3/28/16
	1,500	3	Concrete, two-compartment, two piece, 1,000-gallon septic tank + 500-gallon dosing chamber or 1,500-gallon septic tank	3/28/16

Septic Tank Manufacturer	Unit Liquid Volume (gallons)	Maximum Bury Depth (feet)	Tank Description (material, number of compartments, number of pieces, uses)	Approval Date (month/day/year)
<b>Byington Memorial and Funeral Products, LLC</b> P.O. Box 2062 Idaho Falls, ID 83403 (208) 552-5165	1,000	3	Concrete, single compartment, two piece	10/14/97
	1,000	3	Concrete, two compartment, <sup>a</sup> two piece	7/3/01
<b>Coeur d'Alene Paving</b> 120 E. Anton Avenue Coeur d'Alene, ID 83815 (208) 762-0235	1,000	3	Concrete, single compartment, two piece	9/9/19
	1,000	3	Concrete, two compartment, two piece	9/9/19
	1,000	3	Concrete, single compartment, one piece	9/9/19
	1,500	3	Concrete, single compartment, one piece	9/9/19
	1,500	3	Concrete, single compartment, two piece	9/9/19
	1,500	3	Concrete, two compartment, two piece	9/9/19
<b>Clearwater Concrete, Inc.</b> P.O. Box 446 Kooskia, ID 83539 (208) 926-0103	1,000	3	Concrete, single compartment, one piece	5/21/03
<b>Cooper Ready-Mix</b> 11 Cooper Circle Salmon, ID 83467 (208) 926-0103	1,000	3	Concrete, one or two compartment, <sup>a</sup> one piece	3/26/98
	1,500	3	Concrete, one or two compartment, <sup>a</sup> one piece	5/19/98
<b>Dahle's Red-E-Mix, Inc.</b> 522 River St. Salmon, ID 83467 (208) 756-2481	1,000	3	Concrete, single compartment, two piece	7/26/94
	1,000	3	Concrete, single compartment, one piece	6/3/10
	1,500	3	Concrete, single compartment, one piece	6/3/10
	1,500	3	Concrete, two-compartment, one-piece, 1,000-gallon septic tank with integral 500-gallon dosing chamber or 1,500-gallon septic tank	11/6/13
<b>Delta Fiberglass Structure</b> Salt Lake City, UT	1,000	3	Fiberglass, single compartment, one piece	9/6/83

Septic Tank Manufacturer	Unit Liquid Volume (gallons)	Maximum Bury Depth (feet)	Tank Description (material, number of compartments, number of pieces, uses)	Approval Date (month/day/year)
<b>Duke's Septic Tanks</b> Rt. 1 Box 116 Payette, ID 83661	1,000	3	Concrete, single compartment, two piece	2/20/86 7/19/94
<b>Dura-Crete, Inc.</b> P.O. Box 65489 Salt Lake City, UT 84119 (801) 972-8686	1,000 1,250 1,750 2,500	3 3 3 3	Concrete, single compartment, one piece Concrete, single compartment, one piece Concrete, single compartment, one piece Concrete, single compartment, one piece	7/21/94 4/4/86 7/21/94 7/21/94
<b>Evergreen Pre-Cast, Inc.</b> P.O. Box 58 Sumner, WA 98390 (253) 863-6510	900	3	Concrete, single-compartment, one-piece, round, Delta Environmental Products ETPS tank	10/27/04
<b>Everlasting Concrete Products</b> P.O. Box 763 Caldwell, ID 83606 (208) 941-4191	750, 900, 1,250 1,000 1,100	3 3 3	Concrete, single compartment, two piece Concrete, single compartment, two piece Concrete, two-piece, Norweco 500 GPD ETPS tank	12/1/84 12/3/07 7/17/08
<b>Hancey Concrete Precast</b> P.O. Box 305 Millville, UT 84326 (435) 770-5164	1,000 1,000 1,250 1,250 1,500	10 3 10 3 3	Concrete, single compartment, two piece, deep burial Concrete, single compartment, two piece Concrete, single compartment, two piece, deep burial Concrete, single compartment, two piece Concrete, single compartment, two piece	12/2/08 3/24/20 12/2/08 6/16/20 9/16/20
<b>Hunter Septic Tanks</b> 181 E 350 N Blackfoot, ID 83221	1,000 1,250 1,500	3 3 3	Concrete, single compartment, one piece Concrete, two-compartment, <sup>a</sup> one piece Concrete, two-compartment, <sup>a</sup> one piece	6/30/17 6/24/15 6/24/15
<b>Idaho Precast</b> 1389 Madison Ave Nampa, ID 83637	1,000	3	Concrete, single compartment, two piece	3/11/19

Septic Tank Manufacturer	Unit Liquid Volume (gallons)	Maximum Bury Depth (feet)	Tank Description (material, number of compartments, number of pieces, uses)	Approval Date (month/day/year)
<b>Infiltrator Water Technologies, LLC</b> P.O. Box 768 Old Saybrook, CT 06475 (800) 221-4436	900	4	TW-900 (outlet hole “C”), plastic, single compartment, two piece	4/15/09
	1,050	4	TW-1050 (outlet hole “C”), plastic, single compartment, two piece	4/15/09
	1,250	4	TW-1250 (outlet hole “C”), plastic, single compartment, two piece	4/15/09
	1,500	4	TW-1500 (outlet hole “C”), plastic, single compartment, two piece	4/15/09
	1,060	4	IM-1060, molded PE or PP plastic, single compartment, two piece	7/25/11
	475	4	IM-540, molded PE or PP plastic, single compartment, two piece	3/4/14
	1,500	4	IM-1530, molded PE or PP plastic, single compartment, two piece	3/4/14
<b>Inland Northwest Precast</b> 5516 N. Starr Rd. Newman Lake, WA 99025 (509)-226-5050	1,000	5	Concrete, single compartment, traffic rated and non-traffic rated	12/19/19
	1,000	5	Concrete, double compartment, traffic rated and non-traffic rated	12/19/19
	1,500	5	Concrete, single compartment, traffic rated and non-traffic rated	12/19/19
	1000	5	Concrete, two compartments + pump chamber, traffic and non-traffic rated	12/19/19
	1,500	5	Concrete, two compartments, traffic rated and non-traffic rated	12/19/19
<b>Jerome Precast, LLC</b> (Purchased by Triple C Concrete; tanks awaiting inspection and approval prior to transfer. These models may not be installed by Triple C Concrete until transferred to their approved product list)	1,250	3	Concrete, single compartment, one piece	8/26/96
	1,500	3	Concrete, one- or two-compartment, one-piece, 1,000-gallon septic tank with integral 500-gallon dosing chamber or 1,500-gallon septic tank	3/24/03
	1,000	3	Concrete, single-compartment, one-piece, BioMicrobics 0.5 MicroFAST ETPS tank	5/20/09
	1,500	3	Concrete, single-compartment, one-piece, BioMicrobics 0.75 and 0.9 MicroFAST ETPS tank	5/20/09
<b>Johnson AAA Tanks, LLC</b> 159 W. 1 <sup>st</sup> N. Rigby, ID 83442 (208) 552-1717	1,500	3	Concrete, single compartment, one piece	1/11/05
	1,000	3	Concrete, single compartment, one piece	1/11/05
	1,500	3	Concrete, two compartment, <sup>a</sup> one piece	8/23/00
<b>Johnson Precast, LLC</b> 551 East Moody Rd.	1,000	3	Concrete, two compartment, <sup>a</sup> two piece	8/1/03
	1,500	3	Concrete, single compartment, one piece	9/16/05

Septic Tank Manufacturer	Unit Liquid Volume (gallons)	Maximum Bury Depth (feet)	Tank Description (material, number of compartments, number of pieces, uses)	Approval Date (month/day/year)
Rigby, ID 83440 (208) 656-9977	1,000	3	Concrete, 500-GPD Norweco ETPS tank	12/2/08
<b>Kanta Products, Inc.</b> P.O. Box 96 Three Forks, MT 59752 (406) 285-3261	1,000	3	Concrete, single compartment, two piece	10/24/85
	1,500	3	Concrete, single compartment, two piece	11/8/11
	1,000 + 500	3	Concrete, two-compartment, two-piece, 1,000-gallon septic tank + integral 500-gallon dosing chamber only	5/7/14
	1,500	3	Concrete, two compartment, <sup>a</sup> two piece	5/7/14
<b>L/R Schuldt Inc.</b> <b>DBA K&amp;G Contractors</b> 6211 S. 15 <sup>th</sup> W. Idaho Falls, ID 83402	1,000	8	Concrete, one compartment, one piece, round	5/14/98
	1,000, 1,500	8	Concrete, one compartment, one piece, rectangular	10/16/09
	1,000	3	Concrete, Southern ETPS tank	7/22/02
	2,000	4	Concrete, one compartment, one piece	11/20/02
<b>LarKen Precast, LLC</b> 411 Remington Boise, ID 83714 (208) 377-2440	1,000, 1,250, 1,500	3	Concrete, single compartment, one piece	5/13/81
	1,000	3	Concrete, two compartment, <sup>a</sup> two piece	9/11/95
	2,000	12 or HS20	Concrete, one- or two-compartment, two-piece, 1,250-gallon septic tank + integral 850-gallon dosing chamber or 2,000-gallon septic tank	4/29/16
	1,000	3	Concrete, single compartment, one-piece BioMicrobics 0.50 and 0.75 MicroFAST ETPS tank	5/22/18
	1,250	3	Concrete, two-compartment, one-piece BioMicrobics 0.50 and 0.75 MicroFAST ETPS tank	5/22/18
	2,500	3	Concrete, single compartment, one piece	12/18/98
	800	3	Concrete, single compartment, one piece	5/24/99
	1,250	3	Concrete, one- or two-compartment, one-piece, 900-gallon septic tank + integral 300-gallon dosing chamber or 1,250-gallon septic tank	7/21/00



Septic Tank Manufacturer	Unit Liquid Volume (gallons)	Maximum Bury Depth (feet)	Tank Description (material, number of compartments, number of pieces, uses)	Approval Date (month/day/year)
<b>Miller Septic Tanks</b> 319 Orchard Dr. Twin Falls, ID 83303	1,000	3	Concrete, single compartment, two piece	3/22/95
	1,000	3	Concrete, single compartment, two piece	6/13/95
	1,250,1,350	3	Concrete, single compartment, two piece	7/18/95
	1,000, 1,500	3	Concrete, single compartment, one piece	6/24/04
	1,000	3	Concrete, two-compartment, one-piece, 665-gallon septic tank + 335-gallon dosing chamber or 1,000-gallon septic tank	6/24/04
	1,500	3	Concrete, two-compartment, one-piece, 1,000-gallon septic tank + 500-gallon dosing chamber or 1,500-gallon septic tank	6/24/04
<b>Missoula Concrete Const.</b> 8012 Deschamps Ln. Missoula, MT 59808 (406) 549-9682	3,000	3	Concrete, single compartment, two piece	11/1/94
	6,000	3	Concrete, single compartment, two piece	11/1/94
<b>Norwesco</b> 4365 Steiner St. St. Bonifacius, MN 55375 (800) 328-3420	750, 1,000, 1,250	3	Polyethylene, single compartment, one piece, one and two manhole, yellow	5/13/81
	1,500	3	Polyethylene, one- or two-compartment, one piece, 1,000-gallon septic tank + 500-gallon dosing chamber or 1,500-gallon septic tank, yellow	11/6/95
	1,000, 1,250, 1,500	3	Polyethylene, cisterns, single compartment, one piece, white	12/17/96
	1,250, 1,500	3	Polyethylene, one compartment, one piece, low profile septic, green	8/17/17
	1,000, 1,250	3	Polyethylene, "Bruiser," single compartment, one piece, light blue	11/13/03

Septic Tank Manufacturer	Unit Liquid Volume (gallons)	Maximum Bury Depth (feet)	Tank Description (material, number of compartments, number of pieces, uses)	Approval Date (month/day/year)
<b>Oldcastle Precast (Amcors)</b>	1,000, 1,250, 1,500	3	Concrete, single compartment, two piece	—
2240 S. Yellowstone Idaho Falls, ID 83402 (208) 522-6150	4,000	3	Concrete, single compartment, two piece	6/12/92
	1,000	3	Concrete, single compartment, two piece	9/14/94
	1,000	3	Concrete, single compartment, one piece (from Snake River Precast)	4/25/06
	1,000	3	Concrete, single compartment, one piece (from Boise Vault)	1/1/77
	1,250, 1,500	3	Concrete, single compartment, one piece	11/7/96
	1,500	3	Concrete, single compartment, one piece (from Snake River Precast)	4/25/06
	2,000	4	Concrete, single compartment, one piece	11/2/09
	2,500	4	Concrete, single compartment, one piece	11/2/09
	3,000	4	Concrete, single compartment, one piece	11/2/09
	3,140	3	Concrete, single compartment, two piece	7/30/93
	1,500	3	Concrete, two compartment, <sup>a</sup> two piece, low profile	8/24/94
	2,000	3	Concrete, single compartment, two piece	8/24/94
	1,000	3	Concrete, two compartment, <sup>a</sup> two piece, low profile	3/9/98
	1,000 + 500	3	Concrete, two-compartment, two-piece, 1,000-gallon septic tank + 500-gallon dosing chamber only	5/17/99
	1,150	3	Concrete, three-compartment, two-piece, Jet Inc. ETPS tank	9/16/02
	1,000	8 or HS20	Concrete, two-compartment <sup>a</sup> (baffled), one piece	1/18/08
	1,500	8 or HS20	Concrete, single-compartment, one piece	1/18/08
	1,500	8 or HS20	Concrete, two-compartment, <sup>a</sup> one piece	1/18/08

Septic Tank Manufacturer	Unit Liquid Volume (gallons)	Maximum Bury Depth (feet)	Tank Description (material, number of compartments, number of pieces, uses)	Approval Date (month/day/year)
<b>Oldcastle Precast</b> 16419 Ten Lane Nampa, ID 83687	1,000	3	Concrete, single-compartment, one piece	3/4/19
	2,990	8 (HS-25)	Concrete, single-compartment, two piece	5/8/09
	4,180	8 (HS-25)	Concrete, single-compartment, two piece	4/3/13
	1,250	3	Concrete, single-compartment, one-piece, alternate inlet/outlet locations	5/14/19
	1,500	3	Concrete, single-compartment, one-piece, alternate inlet/outlet locations	3/11/19
	1,000	3	Concrete, single-compartment, one-piece, Bio-Microbics ETPS tank, alternate inlet/outlet locations	5/14/19
	1,250	3	Concrete, two-compartment, <sup>a</sup> one-piece, Bio-Microbics ETPS tank, alternate inlet/outlet locations	5/14/19
<b>Orengo Systems, Inc.</b> 814 Airway Avenue Sutherlin, OR 97479 (800) 348-9843	1,000, 1,500	4	Fiberglass, one or two compartments, <sup>a,b</sup> two piece; two-compartment baffle location must meet minimum volume requirements of IDAPA 58.01.03.007.16	6/24/04
<b>Owyhee Sand and Gravel</b> 2085 River Rd. Homedale, ID 83628 (208) 337-5057	1,000	3	Concrete, single compartment, two piece	3/10/00
<b>Panhandle Concrete Products, Inc.</b> 6285 N. Pleasant View Rd. Post Falls, ID 83854 (208) 773-0606	1,000	3	Concrete, single compartment, two piece	12/14/81
	1,000+ 500	3	Concrete, two-compartment, two-piece, 1,000-gallon septic tank with an integral 500-gallon dosing chamber or 1,500-gallon septic tank	12/14/81
	2,000 + 500	3	Concrete, two-compartment, two-piece, 2,000-gallon septic tank with an integral 500-gallon dosing chamber only	12/14/81
	2,500, 3,000	3	Concrete, single compartment, two piece	1/30/85
<b>Roth Global Plastics, Inc.</b> P.O. Box 245 Syracuse, NY 13211 (315) 475-0100	1,060	3	HDPE, single compartment, two piece, inlet/outlet at hole "A"	6/1/09
	1,250	3	HDPE, single compartment, two piece, inlet/outlet at hole "A"	6/1/09
	1,500	3	HDPE, single compartment, two piece, inlet/outlet at hole "A"	6/1/09

Septic Tank Manufacturer	Unit Liquid Volume (gallons)	Maximum Bury Depth (feet)	Tank Description (material, number of compartments, number of pieces, uses)	Approval Date (month/day/year)
<b>Rupp Trucking Ent., Inc.</b> 7905 West 9600 North Tremonton, UT 84337 (435) 257-7333	1,000	3	Concrete, single compartment, two piece	4/4/86
	1,250	3	Concrete, single compartment, two piece	11/18/99
<b>Triple C Concrete</b> P.O. Box 923 Twin Falls, ID 83303 (208) 733-7141	1,000	3	Concrete, single compartment, two piece	7/17/86
	1,000	3	Concrete, single compartment, two piece, low profile	5/13/96
	1,000	3	Concrete, single compartment, one piece	6/16/08
	1,500	3	Concrete, single compartment, one piece	6/16/08
	1,500	3	Concrete, two-compartment, one-piece, 1,000-gallon septic tank with integral 500-gallon dosing chamber or 1,500-gallon septic tank	6/16/08
	1,000	3	Concrete, single compartment, one piece (from Jerome Precast, LLC)	7/8/96
<b>Valley Precast, Inc.</b> 6633 Summer Hill Rd. Boise, ID 83714 (208) 853-0661	1,000	8	Concrete, single compartment, one piece	6/21/11
	1,500	3	Concrete, two-compartment, one-piece, 1,000-gallon septic tank with integral 500-gallon dosing chamber or 1,500-gallon septic tank	7/17/00
	1,500	3	Concrete, single-compartment, one-piece, Bio-Microbics ETPS tank, alternate inlet/outlet locations (5/20/08)	07/11/03
<b>White Block Company, Inc.</b> 6219 East Trent Ave. Spokane Valley, WA 99212 (509) 543-0651	1,000, 1,250, 1,500	3	Concrete, single compartment, one piece	4/2/86
	2,000, 2,500	3	Concrete, single compartment, two piece	4/2/86

Septic Tank Manufacturer	Unit Liquid Volume (gallons)	Maximum Bury Depth (feet)	Tank Description (material, number of compartments, number of pieces, uses)	Approval Date (month/day/year)
<b>Wilbert Precast, Inc.</b> 2215 East Brooklyn Spokane, WA 99217 (509) 325-4573	1,000	3	Concrete, two compartment <sup>a</sup> , one or two piece	9/23/14
	1,000 + 500	3	Concrete, two-compartment, one-piece, 1,000-gallon septic tank with integral 500-gallon dosing chamber only	6/12/13
	750, 1,000, 1,250, 1,500	3	Concrete, single compartment, one or two piece	2/6/81
	1,500	3	Concrete, one- or two-compartment, two-piece, 1,000-gallon septic tank with integral 500-gallon dosing chamber or 1,500-gallon septic tank	3/21/97
	2,000	3	Concrete, single compartment, two piece	9/19/13
	3,000	3	Concrete, single compartment, three piece	4/4/03
	5,215	8 or HS20	Concrete, single compartment, four piece, traffic rated	12/7/06
5,215	8 or HS20	Concrete, two-compartment, four-piece, traffic-rated, 3,475-gallon septic tank with integral 1,740-gallon dosing chamber or 5,215-gallon septic tank	8/15/13	
<b>Xerxes Corporation</b> 7901 Xerxes Ave. South Minneapolis, MN 55431	2,500, 3,400, 4,200, 5,000	7	FRP, single wall, one- or two-compartment, one piece	6/7/06

a. Indicates that the compartments are not hydraulically isolated and the second compartment is not a dosing chamber for use in individual subsurface sewage disposal system designs. Nonhydraulically isolated tanks may be used for septic tank effluent pump (STEP) stations as long as the STEP tank precedes a central secondary wastewater treatment system and is included in the approved plans and specifications for the collection system for use as an individual residence wastewater pumping station.

b. In a STEP pumping application, the tank's nominal volume would be calculated from the inlet invert, which is 1086 and 1615, respectively because no gravity outlet would be installed.

Notes: Extended treatment package system (ETPS); polyethylene (PE); polypropylene (PP); high-density polyethylene (HDPE); fiberglass-reinforced plastic (FRP)

### 5.3 Approved Dosing Chambers

Revision: May 21, 2015

Table 5-2 lists dosing chambers approved for use by DEQ.

**Table 5-2. Dosing chambers approved for use by DEQ.**

Dosing Chamber Manufacturer	Unit Liquid Volume (gallons)	Maximum Bury Depth (feet)	Chamber Description (number of pieces and material)	Approval Date (month/day/year)
<b>Johnson AAA Tanks, LLC</b> 159 W. 1 <sup>st</sup> N. Rigby, ID 83442 (208) 552-1717	500	3	One piece, concrete,	1/11/05
<b>Bonner Concrete Products, Inc.</b> P.O. Box 321 Sagle, ID 83860 (208) 263-3979	500	3	One piece, concrete	6/21/11
<b>Cooper Ready-Mix</b> 11 Cooper Circle Salmon, ID 83467 (208) 756-4475	500	3	One piece, concrete	11/22/00
<b>Infiltrator Water Technologies, LLC</b> P.O. Box 768 Old Saybrook, CT 06475 (800) 221-4436	552	4	IM-540, molded PE or PP plastic, single compartment, two piece	3/4/14
<b>L/R Schuldt Inc., DBA K&amp;G Contractors</b> 6211 S. 15 <sup>th</sup> W. Idaho Falls, ID 83402	500	3	Two piece, round, concrete	5/14/98
<b>Miller Septic Tanks</b> 319 Orchard Dr. Twin Falls, ID 83303	500	3	One piece, concrete	6/24/04

## 5.4 Extended Treatment Package Systems

Revision: May 28, 2019

Table 5-3 lists ETPSs approved by DEQ for provisional use. Table 5-4 lists ETPSs approved by DEQ for general use. Provisional use approval requires that manufacturers follow specific OMM protocols to obtain general use approval (section 1.4.2.2.1). General use approval allows manufacturers' ETPS units to be installed following specific O&M protocols (section 1.4.2.2.2). Provisional and general ETPS approvals are effective as of July 1, 2016.

**Table 5-3. Extended treatment package systems approved by DEQ for provisional use.**

Manufacturer	Model	Treatment Limit (GPD)	Third-Party Standards (TPS) or Experimental	Operation, Maintenance, and Monitoring Provider	Approval Date
Aero-Tech Aerobic Treatment Units 2900 Gary Drive Plymouth, IN 46563 (574) 935-0908 <a href="http://www.aerotech-atu.com">www.aerotech-atu.com</a>	AT-500 Class I	500	TPS	Service provider and third-party tester	11/26/08
	AT-600 Class I	600			
	AT-750 Class I	750			
	AT-1000 Class I	1,000			
	AT-1500 Class I	1,500			
Aquapoint.3, LLC 39 Tarkiln Place New Bedford, MA 02745 (505) 985-9050 <a href="http://www.aquapoint.com">www.aquapoint.com</a>	Bioclere 16/12/500: Class I	500	TPS	Service provider and third-party tester	3/19/91
Bio-Microbics®, Inc. 16002 W. 110th St. Lenexa, KS 66219 (913) 422-0707 <a href="http://www.biomicrobics.com">www.biomicrobics.com</a>	BioBarrier® MBR 0.4 Class I	400	TPS	Service provider and third-party tester	—
	BioBarrier® MBR 0.4-N Class I	400			
	BioBarrier® MBR 0.5 Class I	500			
	BioBarrier® MBR 0.5-N Class I	500			
	BioBarrier® MBR 1.0 Class I	1,000			
	BioBarrier® MBR 1.0-N Class I	1,000			
	BioBarrier® MBR 1.5 Class I	1,500			
BioBarrier® MBR 1.5-N Class I	1,500				
Busse Innovative Systeme GmbH Zaucheweg 6 Leipzig, Germany D-04316 1 (708) 204-3504 <a href="http://www.busse-gt.com">www.busse-gt.com</a>	MF-B-400	400	TPS	Service provider and third-party tester	7/7/09

Manufacturer	Model	Treatment Limit (GPD)	Third-Party Standards (TPS) or Experimental	Operation, Maintenance, and Monitoring Provider	Approval Date
Consolidated Treatment System Inc. 1501 Commerce Center Dr. Franklin, OH 45005 (937) 746-2727 <a href="http://www.consolidatedtreatment.com">www.consolidatedtreatment.com</a>	Multi-Flo FTB: Class I	500 to 1,500	TPS	Service provider and third-party tester	4/2/96
	0.5, 0.6, 0.6-C, 0.75, 1.0, 1.5 Nayadic M: Class I 6A, 8A, 1050A, 1200A, 2000A	500 to 1,500			4/2/96
Ecological Tanks, Inc. 2247 Highway 151 North Downsville, LA 71234 (318) 644-0397 <a href="http://www.etiaquasafe.com">www.etiaquasafe.com</a>	AA, AS 500 Class I	500	TPS	Service provider and third-party tester	11/1/97
	AA, AS-650 Class I	650			5/2/02
	AA, AS-750 Class I	750			
	AA, AS-100 Class I	1,000			
Enviro-Flo: Class I 235 Flowood Dr. Flowood, MS 39232 (887) 836-8476 <a href="http://www.enviro-flo.net">www.enviro-flo.net</a>	E-500, E-550	500	TPS	Service provider and third-party tester	12/18/02
	E-550	550			
	E-600	600			
	E-750	750			
Hydro-Action, Inc.: Class I 2055 Pidco Dr. Plymouth, IN 46563 (574) 936-2542 <a href="http://www.hydro-action.com">www.hydro-action.com</a>	AP-500, 600, 750, 900, 1500	500 to 1,500	TPS	Service provider and third-party tester	4/2/96
Jet Inc.: Class I 750 Alpha Drive Cleveland, OH 44143 (800) 321-6960 <a href="http://www.jetincorp.com">www.jetincorp.com</a>	J-500, J-600	500	TPS	Service provider and third-party tester	10/96
	J-750, 1000, 1250, 1500	600 750–1,500			5/93 7/29/97



Manufacturer	Model	Treatment Limit (GPD)	Third-Party Standards (TPS) or Experimental	Operation, Maintenance, and Monitoring Provider	Approval Date
Lowridge Onsite Technologies PO Box 1179 Lake Stevens, WA 98258 (877) 476-8823 <a href="http://lowridgetech.com/">http://lowridgetech.com/</a>	LOWeFLOW™ Treatment System, LF-500	500	TPS	Service provider and third-party tester	3/30/18
National Wastewater Systems Inc., 6754 Hwy 90 East Lake Charles, LA 70615 (337) 439-0680 <a href="http://www.solarair.biz">www.solarair.biz</a>	Solar Air 500, 800, 1000, 1200	500 800 1,000 1,200	TPS	Service provider and third-party tester	8/1/03
SeptiTech 69 Holland St. Lewiston, ME 04240 (207) 333-6940 <a href="http://www.septitech.com">www.septitech.com</a>	STAAR 0.5 STAAR 0.75 STAAR 1.0 STAAR 1.2 STAAR 1.5	500 750 1,000 1,200 1,500	TPS	Service provider and third-party tester	12/09

Note: gallons per day (GPD)

**Table 5-4. Extended treatment package systems approved by DEQ for general use.**

Manufacturer	Model	Treatment Limit (GPD)	CBOD <sub>5</sub> (≤40 mg/L) and TSS (≤45 mg/L) Removal	Operation and Maintenance Provider	Approval Date
Bio-Microbics®, Inc. 16002 W. 110th St. Lenexa, KS 66219 (913) 422-0707 <a href="http://www.biomicrobics.com">www.biomicrobics.com</a>	RetroFAST® 0.375: Class I	375	Yes	Service provider	—
Bio-Microbics®, Inc. 16002 W. 110th St. Lenexa, KS 66219 (913) 422-0707 <a href="http://www.biomicrobics.com">www.biomicrobics.com</a>	MicroFAST® 0.5 Class I	500	Yes	Service provider	3/5/97
	MicroFAST® 0.75 Class I	750			6/5/00
	MicroFAST® 0.9 Class I	900			12/27/02
	MicroFAST® 1.5 Class I	1,500			
Norweco, Inc. 220 Republic St. Norwalk, OH 44857 (419) 668-4471 <a href="http://www.norweco.com">www.norweco.com</a>	Singulair 960 series	1,500	Yes	Service provider	4/3/96
	Singulair TNT	1,500			8/96
Orenco Systems Inc. 814 Airway Ave. Sutherlin, OR 97479 (800) 348-9843 <a href="http://www.orenco.com">www.orenco.com</a>	AdvanTex AX20N	500	Yes	Service provider	4/10/02
	AdvanTex AX20-RT	500			
	AdvanTex AX15-2N	800			
	AdvanTex AX20-2N	1,000			3/1/10
	AdvanTex AX15-3N	1,200			6/11/12
	AdvanTex AX20-3N	1,500			
	AdvanTex AX25-RT3N	625			

Notes: gallons per day (GPD); 5-day carbonaceous biological oxygen demand (CBOD<sub>5</sub>); milligram per liter (mg/L); total suspended solids (TSS)

## 5.5 Approved Nondischarging Products

Revision: March 4, 2019

Table 5-5 through Table 5-8 list nondischarging products currently approved by DEQ.

**Table 5-5. Composting toilets.**

<b>Recycle/Reuse and Water Conservation Devices (NSF STD 41)</b>	<b>Treatment System</b>	<b>Model</b>	<b>Notes</b>	<b>Certification Date</b>
Advanced Composting Systems	Composting toilets	ACS 200	CSA certified	8/94
Biological Mediation Systems, Inc.	Composting toilets	Devap 2000	Not certified by NSF	12/95
Clivus Multrum, Inc.	Composting toilets	08 / 08 M-12 / M-15 M-18 / M-22 M-25 / M-28 M-32 / M-35	—	2/98
EcoTech Batch Composting Toilet, Carousel	Composting toilets	Model 80 A	—	12/97
Sancor Industries, LTD	Composting toilets	Waterless self-contained Waterless remote	CSA certified	7/94
Sun-Mar Corp.	Composting toilets	Sun-Mar- Excel	—	6/93

Notes: National Sanitary Foundation (NSF); CSA International Group (CSA)

**Table 5-6. Individual wastewater incinerators.**

Incinerating Toilets	Model	Notes	Requirements	Approval Date
SWSLOO, Inc. 2005 FM 1704 Elgin, TX 78621-5522 Phone: (866) 797-3566 (ELOO) E-mail: <a href="mailto:info@swsloo.com">info@swsloo.com</a> Website: <a href="http://www.swsloo.com">www.swsloo.com</a>	THE ENVIRO LOO® 2010 Standard			
	THE ENVIRO LOO® 2040 Standard	Solar and Wind Evaporative Toilet	N/A	2010
ECOJOHN 17282 Mount Wynne Circle Fountain Valley, CA 92708 714-658-1077 1-866-ECOJOHN	ECOJOHN SR	Gas-fired	N/A	2007
	WC5 Mini	Propane or gas-fired	Toilets only	2016
	WC5	Propane, gas, or diesel-fired	25 GPD max, minimum 600 gallon storage tank	2016
	WC32	Propane, gas, or diesel-fired	75 GPD max, minimum 800 gallon storage tank	2016
	WC48	Propane, gas, or diesel-fired	125 GPD max, minimum 1,000 gallon storage tank	2016
	WC64	Propane, gas, or diesel-fired	300 GPD max, minimum 1,000 gallon storage tank	2016
Research Products/Blankenship Incinolet (800) 527-5551	CF (120v) TR (208v, 240v) RV (120v)	120 V or 240 V	—	2001
	WB (120v 208v, 240v)	Marine	—	2001
Storburn (519) 442-4731	60K	Gas-fired	—	1993

Notes: not applicable (N/A); gallons per day (GPD)

**Table 5-7. Vault toilets.**

Vault Manufacturer	Vault Volume (gallons)	Vault Description	Effective date (month/day/year)
<b>Boom Concrete, Inc.</b> 202 Girard Ave. Newell, SD 57760 <a href="http://www.boomcon.com/">http://www.boomcon.com/</a>	1,200	Concrete, one-piece, vault toilet tank, building structure integral with vault lid	4/16/2018
<b>CXT Precast Concrete Products, Inc.</b> 3808 N. Sullivan Rd., Bldg. 7 Spokane, WA 99216	1,000	Concrete, one-piece, vault toilet tank, building structure integral with vault lid	5/30/02
<b>Missoula Concrete Construction</b> 8012 Deschamps Ln. Missoula, MT 59808 (406) 549-9682	1,000	Concrete, one-piece, vault toilet tank, building structure integral with vault lid	7/11/02
<b>Park and Restroom Structures, Inc.</b> P.O. Box 13280 Spokane Valley, WA 99213-3280	1,200	Concrete, one-piece, vault toilet tank, building structure integral with vault lid	6/1/09
<b>UBC Precast Concrete Products</b> 464 West Highway 26 Blackfoot, Idaho 83221 <a href="http://www.ubcprecast.com/">http://www.ubcprecast.com/</a>	1,000	Concrete, one-piece, vault toilet tank, building structure integral with vault lid	3/14/2018

**Table 5-8. Other nondischarging products.**

Manufacturer	Model	Notes	Requirements	Approval Date
Dry Flush LLC 700 Sherman Ave. Hamden, CT 06514 Phone: (203) 248-4400 E-mail: sales@dry-flush.com Website: <a href="http://www.dry-flush.com">www.dry-flush.com</a>	Model DF1045	N/A	N/A	12/13/2018

## 5.6 Gravelless Trench Components

Revision: January 22, 2019

Table 5-9 shows the components of gravelless trenches, along with their certification date. Table 5-10 provides trench and product width-to-rating correlation.

**Table 5-9. Gravelless trench components.**

Gravelless Drainfield Systems	Chambers, Bundled or Large Diameter Pipe	Model	Sizing Factor (%)	Rating (ft <sup>2</sup> /ft)	Unit Dimensions	Certification Date
Advanced Drainage Systems	Lg. dia. pipe	SB-2 (Ø8 in.)	25	1.33	20 ft rolls	9/82
		SB-2 (Ø10 in.)	25	1.33	20 ft rolls	
Infiltrator Water Technologies, LLC Advanced Drainage Systems <sup>a</sup> Bio-Diffuser Chambers <sup>a</sup> Hancor <sup>a</sup>	Chamber	Quick4 Standard	25	4.00	34 x 48 x 12 in.	7/05
		Quick4 Plus Standard	25	4.00	34 x 48 x 12 in.	6/09
		Quick4 Plus Standard LP	25	4.00	34 x 48 x 8 in.	6/09
		Quick4 Equalizer 36	25	2.67	22.8 x 48 x 10 in.	7/05
		Arc 36	25	4.00	34.5 x 60 x 13 in.	1/06
		Arc 36 LP	25	4.00	33.5 x 60 x 8 in.	12/14
		Standard 1100BD	25	4.00	34 x 76 x 11 in.	12/92
		High capacity 1400BD	25	4.00	34 x 76 x 14 in.	12/92
EPS pipe		EZflow 1201P <sup>d</sup> and 1201P-GEO <sup>c, d</sup>	25	1.33	Ø12 x 60 in. Ø 12 x 120 in.	2/04
		EZflow 1202H <sup>e</sup> and 1202H-GEO <sup>c, e</sup>	25	2.67	Ø 24 x 60 in. Ø 12 x 120 in.	2/04
		EZ flow 1203H <sup>f</sup> and 1203H-GEO <sup>c, f</sup>	25	4.00	Ø 24 x 60 in. Ø 12 x 120 in.	10/07

Gravelless Drainfield Systems	Chambers, Bundled or Large Diameter Pipe	Model	Sizing Factor (%)	Rating (ft <sup>2</sup> /ft)	Unit Dimensions	Certification Date
Plastic Tubing Industries, Inc. Multi-Pipe Rock Replacement Distribution System	Bundled pipe	9-pipe system	25	1.33	10 ft lengths	5/98
		11-pipe system	25	1.33	10 ft lengths	5/98
		13-pipe system	25	1.33	10 ft lengths	5/98
Prinsco, Inc.	Lg. dia. pipe	Goldline GLP (Ø8 in.)	25	1.33	10 and 20 ft lengths	12/95
		Goldline GLP (Ø10 in.)	25	1.33	10 and 20 ft lengths	

- a. Infiltrator Water Technologies, LLC. acquired the Arc, Hancor, and Bio-Diffuser product lines from Advanced Drainage Systems, Inc. Product markings may change to reflect new ownership.
  - b. GSF system design includes 12 inches of modified ASTM C-33 sand at trench bottom.
  - c. Geo suffix indicates product contains geotextile fabric inside the mesh. Geotextile should be oriented on top to limit soil intrusion.
  - d. In 1-foot wide trench
  - e. In 2-foot wide trench
  - f. In 3-foot wide trench
- Note: Expanded polystyrene (EPS)

**Table 5-10. Trench and product width-to-rating correlation.(The measured width of the product must be at least 90% of the design trench width.)**

Trench Width (inches)(feet)	Product Measured Width must be at least (inches)	Rating = Design Trench Width divided by 0.75 ft <sup>2</sup> /lineal foot
36 (3.0)	32.4	4.00
30 (2.5)	27.0	3.33
24 (2.0)	21.6	2.67
18 (1.5)	16.2	2.00
12 (1.0)	10.8	1.33

## 5.7 Pump Vaults

Revision: February 6, 2014

Table 5-11 shows septic tank pump vaults certified by DEQ.

**Table 5-11. Septic tank pump vaults certified by DEQ.**

Pump Vault Manufacturer	Model #	Unit Dimensions	Certification Date	NSF Certification
<b>Concentric Systems</b>	PF-1645 series	16 in. dia. pump filter x 45, 50, 55, 60 in. tall	10/7/97	
	PF1445-FI series	14 in. dia. pump filter x 45, 50, 55, 60 in. tall	10/7/97	
	EF210, EF210-D	10 in. diameter case, 2 parallel EF210 filters	10/7/97	
<b>Northwest Cascade, Inc.</b>	Disk/Screen Effluent Filter	50 x 18 in. adjust filter stand length, six 1/8 in. screens	6/5/00	
		40 x 18 in. adjust filter stand length, six 1/8 in. screens	6/5/00	
<b>Orengo Systems, Inc.</b> 814 Airway Avenue Sutherlin, OR 97479 (800) 348-9843	PVU Series	Biotube pump vault	6/12/02	
	SV Series	Screened pump vault	12/13/99	
	OSI 12000	12 in. diameter x 48 in. tall	3/87	
<b>Zabel Wastewater Systems</b>	FPV-100	15 in. diameter filter pump vault, 36 or 48 in. tall (dosing chamber only)	5/19/98	
<b>Zoeller Pump Co.</b>	P/N 170-0101	Filter and pump chamber 15-3/8 in. dia. x 34 in. tall	10/31/02	
	P/N 170-0126	Filter and pump chamber 17-9/16 in. dia. x 55-3/4 in. tall, field fitted for openings Does not include packages with pumps rated at >30 GPM.	10/31/02	



## 5.8 Septic Tank Effluent Filters

Revision: December 4, 2019

Table 5-12 shows septic tank effluent filters currently certified by DEQ.

**Table 5-12. Septic tank effluent filters certified by DEQ.**

Effluent Filter	Model #	Unit Dimensions	Septic Tank Liquid Depth	Approval Date	NSF Certification
BioMicrobics 16002 W 110th Street Lenexa, KS 66219 (913) 422-0707	SaniTEE	4 in., 8 in. and 16 in. diameters	Variable	12/4/19	—
Bio Weir Filters, Inc. 3 Milton Ave. Newnan, GA 30263 (770) 301-6603	D/F SC/9	—	—	—	11/3/03
Bowco Industries 5486 S.E. International Way Portland, OR 97222 (888) 232-9991	EF-235	Total overall height 27.5 in. Filter height 25 in. Total overall diameter 4.35 in. Filter diameter 4.00 in.	Fits 4 in SDR-35 or Schedule 40 outlet tees Flow rate up to 1,500 GPD	7/28/08	6/2/04
Norweco 220 Republic Street Norwalk, OH 44857-1196 (419) 668-4471	BK 2000	Separate settling/retention basin, 2 ft o.d. x 6 ft 4-1/2 in.	Not applicable	10/18/99	5/6/02
Northwest Cascade, Inc. 16207 Meridian Puyallup, WA 98373 (800) 444-2371	Effluent Filter	24 x 18 in.	Adjust filter stand length	6/5/00	—
Orenco Systems, Inc. 814 Airway Avenue Sutherlin, OR 97479 (800) 348-9843	FT Series FT j Series FT i Series	Biotube Effluent Filters Biotube (jr) Effluent Filters 4 in. dia x 18 in. Biotube Insert Effluent Filters	Order-to-fit tank Up to 45 in. Fits in existing baffle	12/13/99 12/13/99 12/13/99	—

Effluent Filter	Model #	Unit Dimensions	Septic Tank Liquid Depth	Approval Date	NSF Certification
Polylock, Inc. 173 Church Street Yalesville, CT 06492 (800) 234-3119	PL-122 PL-68	4.25 x 4.25 x 12.5 in. (depth) 4.2 x 14.4 in. (depth)	Up to 31.25 in. Fits in existing baffle	10/21/99	6/6/00 12/9/03
Premier Tech 2000 ITEE 1 Avenue Premier Rivière-Du-Loup, Quebec G5R 6C1 Canada (418) 867-8883	EFT-80	—	—	—	11/03/03
Tuf-Tite Inc. 500 Capital Drive Lake Zurich, IL 60047 (800) 382-7009	EF-4 / EF-4 Combo  EF-6 / EF-6 Combo	4 in. diameter for vented tees (1/16 in. filtration)  6 in. diameter x 14 in. high (1/16 in. filtration)	Fits in existing baffle  35 in. liquid depth. Flow rate up to 1,500 gallons per day	8/22/02  7/23/12	5/6/02  9/03
Zabel Wastewater Systems 6244 Old LaGrange Road Crestwood, KY 40014 (800) 221-5742	A100 A300 A1800	11.4 in. diameter x 16 in. high (residential, 1/16 in.) 11.4 in. diameter x 16 in. high (commercial, 1/32 in.) 4 in. diameter for vented tees (1/16 in. filtration)	Variable adjusts w/extension Variable adjusts w/extension Fits existing baffled tank	4/21/88 5/19/98 3/24/94	6/6/00 6/6/00 6/6/00
Zoeller Pump Co. 3649 Cane Run Road Louisville, KY 40211 (502) 778-2731	P/N 170-0078	4 in. diameter for vented tees (1/16 in. filtration)	Fits in existing baffle	8/22/02	5/6/02

Note: gallons per day (GPD)

## 5.9 Pipe Materials for Specified Uses

Revision: June 8, 2017

Table 5-13 shows pipe materials for specified uses.

**Table 5-13. Pipe materials for specified uses.**

Pipe Material and Specification <sup>a,b</sup>		Function			
		Tank to Dosing Chamber	Tanks to Drainfield <sup>c,d</sup>	Gravity Drainfield <sup>c,d</sup>	Pressure Distribution System
ABS Sch. 40 <sup>e</sup>	ASTM D2661	X	X	X	X
	ASTM F628	X	X	X	X
PVC Sch. 40	ASTM F891-10	X	X	X	X
	ASTM D3034 <sup>f</sup>	X	X	X	
PVC	ASTM D2729			X	
	ASTM D2241	X	X	X	X
	AWWA C900	X	X	X	X
	ASTM D2665	X	X	X	
	ASTM D1785	X	X	X	X
PE	AWWA C906	X	X	X	X
	ASTM F810 <sup>g</sup>		X	X	
	ASTM F667 <sup>h</sup>			X	

a. Or equivalent materials as specified by ASTM or AWWA.

b. See State of Idaho Division of Building Safety, Plumbing Bureau for requirements regarding approved building sewer lines between the structure and septic tank.

c. Specified in section 3.2.2 of the *Technical Guidance Manual for Individual and Subsurface Sewage Disposal Systems* (TGM).

d. Must use ASTM D3034 or equivalent as specified in section 3.2.3 of the TGM. ASTM D3033 piping was previously approved for use spanning the tank to dosing chamber, tank to drainfield, and in the drainfield.

e. ABS schedule 40 or piping material of equal or greater strength. Required by IDAPA 58.01.03.007.21.a.

f. Excavation must be compacted with fill material to 90% standard proctor density, with a minimum of 12 inches of cover material. Required by IDAPA 58.01.03.007.02.b.

g. Smooth wall high-density polyethylene (HDPE), white suitable for effluent and drainfield piping.

h. Corrugated HDPE, black with stripe, oblong perforated holes, flexible, suitable for drainfield piping. ASTM F405 withdrawn in 2015 and replaced with ASTM F667.

Notes: polyvinyl chloride (PVC); acrylonitrile-butadiene-styrene (ABS); polyethylene (PE); American Society for Testing and Materials (ASTM); American Water Works Association (AWWA)

## 5.10 Vault Toilets

Revision: April 11, 2018

See Table 5-14 for a list of vault toilets.

**Table 5-14. Vault toilets.**

Vault Manufacturer	Vault Volume (gallons)	Vault Description	Effective date (month/day/year)
<b>Boom Concrete, Inc.</b> 202 Girard Ave. Newell, SD 57760 <a href="http://www.boomcon.com/">http://www.boomcon.com/</a>	1,200	Concrete, one-piece, vault toilet tank, building structure integral with vault lid	4/16/2018
<b>CXT Precast Concrete Products, Inc.</b> 3808 N. Sullivan Rd., Bldg. 7 Spokane, WA 99216	1,000	Concrete, one-piece, vault toilet tank, building structure integral with vault lid	5/30/02
<b>Missoula Concrete Construction</b> 8012 Deschamps Ln. Missoula, MT 59808 (406) 549-9682	1,000	Concrete, one-piece, vault toilet tank, building structure integral with vault lid	7/11/02
<b>Park and Restroom Structures, Inc.</b> P.O. Box 13280 Spokane Valley, WA 99213-3280	1,200	Concrete, one-piece, vault toilet tank, building structure integral with vault lid	6/1/09
<b>UBC Precast Concrete Products</b> 464 West Highway 26 Blackfoot, Idaho 83221 <a href="http://www.ubcprecast.com/">http://www.ubcprecast.com/</a>	1,000	Concrete, one-piece, vault toilet tank, building structure integral with vault lid	3/14/2018

## 5.11 Drainfield Remediation Components

Revision: September 9, 2019

Table 5-15 provides a list of drainfield remediation components.

**Table 5-15. Drainfield remediation components.**

Manufacturer and Distributor	Model and Remediation Type	Certification	Installation	Requirements
Bio-Microbics® <a href="http://www.biomicrobics.com">www.biomicrobics.com</a> Taylor-Morgan 2677 N. Emily Meadows Place Eagle, ID 83616 208-917-7450 <a href="mailto:keith@taylor-morgan.com">keith@taylor-morgan.com</a>	RetroFAST®—PR™ –0.150 –0.250 –0.375 Aerobic	NSF®/ANSI Standard #40 Verification letter	–Complex installer –Factory authorized	–Manufacturer’s checklist –Warranty –Operation and maintenance instructions
Knight Treatment Systems, Inc. <a href="http://www.knighttreatmentsystems.com">www.knighttreatmentsystems.com</a> Wachusett Environmental Lew Reed, PE P.O. Box 129, Holden, Massachusetts 01520 (774) 535-1274 (866) 307- 4282 (fax)	White Knight™ WK-40 WK-78 Microbial Inoculation Generator (MIG)	–Section 4.7 Experimental Systems (TGM) –Idaho Professional Engineer	–Complex installer –Factory authorized	–Manufacturer’s checklist –Warranty –Operation and maintenance instructions
Infiltrator® Water Technologies, LLC <a href="http://www.aquaworx.com">www.aquaworx.com</a> Mathew S. Gibbs P.O. Box 1275, Sandpoint, Idaho 83864 (800) 221-4436 (860) 577-7001 (fax) <a href="mailto:mgibbs@infiltratorsystems.net">mgibbs@infiltratorsystems.net</a>	Aquaworx Remediator™ Aerobic Bacteria Generator (ABG)	–IAPMO IGC 180-2003 –Licensing agreement through Pirana™	–Complex installer –Factory authorized	–Manufacturer’s checklist –Warranty –Operation and maintenance instructions
SludgeHammer® Group Ltd. <a href="http://www.sludgehammer.net">www.sludgehammer.net</a> Ken Morse Northwest Distributor P.O. Box 1771, Olympia, WA 98507 (360) 923-1080 <a href="mailto:Ken@netseptic.com">Ken@netseptic.com</a>	SludgeHammer® –S-46 –S-86 Aerobic Bacteria Generator (ABG)	–IAPMO IGC 180-2003 –Section 4.7 Experimental Systems (TGM) –Idaho Professional Engineer	–Complex installer –Factory authorized	–Manufacturer’s checklist –No warranty –Operation and maintenance instructions

## 5.12 Total Nitrogen Reduction Approvals

Revision: October 26, 2018

On-site wastewater systems that qualify as best practical methods for the targeted nitrogen reduction amount appear in Table 5-16. Areas of concern, such as nitrate priority areas, areas with shallow soils over bedrock, or a shallow depth to ground water, may be required to use one of these best practical methods to reduce the development's or home's environmental impact. Values listed in the TN column should not be exceeded to ensure that the required TN reduction percentage is attained. These TN values may be used in NP evaluations to evaluate the impact on ground water resources. Products installed for reduction of TN less than 27 mg/L are subject to effluent testing (section 4.8).

**Table 5-16. On-site wastewater systems approved for total nitrogen reduction.**

System or Manufacturer Product and Model	Total Nitrogen Reduction <sup>a</sup> (%)	Total Nitrogen <sup>a</sup> (mg/L)	Minimum Source Water Alkalinity <sup>b</sup> (mg/L)
<b>Public Domain Systems</b>			
Intermittent Sand Filters (ISF)	15 <sup>c</sup>	38	108
Recirculating Gravel Filters (RGF)	40 <sup>c</sup>	27	189
<b>Extended Treatment Package Systems</b>			
Busse Innovative Systeme GmbH–MF-B-400	30	32	156
Nayadic	30	32	156
Southern Manufacturing	30	32	156
Jet Inc.	32 <sup>d</sup>	31	163
SeptiTech	55 <sup>e,t</sup>	20	180
Clearstream Model DA	50 <sup>e</sup>	19	225
Orenco–AdvanTex	65 <sup>e,f</sup>	16	269
BioMicrobics	65 <sup>t</sup>	16	269
Norweco–Singular 960 series	65 <sup>d</sup>	16	269
Norweco–Singular TNT	65 <sup>d</sup>	16	269

a. Quantifiable values (milligram per liter [mg/L]) will indicate compliance with the qualitative total nitrogen reduction limit expressed as a percentage (%) reduction.

b. Minimum recommended source water alkalinity to support nitrification in the denitrification process. Use of water softeners is not recommended due to potentially detrimental effects on the biological processes.

c. Literature value

d. Idaho testing

e. Third-party data

f. National Science Foundation data

### 5.13 Proprietary Wastewater Treatment Products

Revision: September 24, 2020

Table 5-17 lists proprietary wastewater treatment product approved by DEQ. Proprietary wastewater treatment products shall be installed by a permitted complex installer.

**Table 5-17. Proprietary wastewater treatment products.**

Proprietary Wastewater Treatment Product Manufacturer and Model	Treatment Limits (GPD)	Designer Requirements	Operation, Maintenance, and Monitoring Requirements	Drainfield Sizing and Size Limits	Vertical Separation Distances	Approval Date	Comments
Eljen Corporation Eljen GSF	None	Idaho licensed professional engineer required for the design of a mound system or if effluent is pressure distributed	Homeowner managed O&M	Table 4-22 for application rates  Drainfield may exceed 1,500 ft <sup>2</sup> when pressurized	Table 4-21	1/22/18 Updated: 3/18/19	Residential: See sections 2.17 and 2.18 of the product manual. Commercial: Contact Eljen for design information. <a href="#">Eljen GSF Idaho Design &amp; Installation Manual</a>
Geomatrix Systems, LLC GeoMat Leaching Systems GeoMat 1200 GeoMat 3900	1,500	Idaho licensed professional engineer required for a mound system or if effluent is pressure distributed	Homeowner managed O&M	Table 4-22 for application rates  1,500 ft <sup>2</sup> when pressurized	Table 4-21	9/24/20	Residential: 78 LF/bedroom (GeoMat 1200) or 24 LF/bedroom (GeoMat 3900)  <a href="#">Idaho GeoMat Leaching Systems Design Manual for Pressure and Gravity Applications – August 2020</a>
Infiltrator Water Technologies, LLC Advanced Treatment Leachfield (ATL)	1,500	Idaho licensed professional engineer required if effluent is pressure distributed	Homeowner managed O&M	Table 4-22 for application rates  Drainfield may exceed 1,500 ft <sup>2</sup> when pressurized	Table 4-21	4/2/18 Updated: 9/03/20	Residential application: 70 LF/bedroom, Nonresidential application: 2.14 GPD/LF.  <a href="#">Design and Installation Manual for the Infiltrator ATL System in Idaho – JUNE 2020</a>

Proprietary Wastewater Treatment Product Manufacturer and Model	Treatment Limits (GPD)	Designer Requirements	Operation, Maintenance, and Monitoring Requirements	Drainfield Sizing and Size Limits	Vertical Separation Distances	Approval Date	Comments
Lowridge Onsite Technologies Onsite Sand Coil Recharge (OSCAR-II): OS-50 OS-100	500 <sup>a</sup>	Idaho-licensed professional engineer required	Homeowner managed O&M	Table 4-22 for application rates	Table 4-21	3/12/19 Updated: 10/2/19	Residential/nonresidential: Number of coils required for the design flow depends on whether OS-50 (50 GPD) or OS-100 (100 GPD) coils are used.
Presby Environmental, Inc. Advanced Enviro-Septic (AES)	1,500	None	Homeowner managed O&M	Table 4-22 for application rates  Drainfield may not exceed 1,500 ft <sup>2</sup>	Table 4-21	08/16/16 Updated: 9/04/20	Residential application: 70 LF/bedroom. Nonresidential application 2.14 GPD/LF.  <a href="#">Presby AES Idaho Design &amp; Installation Manual JUNE 2020</a>

a. System designs with flows above 500 GPD must be proportionally upsized, contact Lowridge Onsite Technologies.

Notes: linear feet (LF); gallons per day (GPD); square feet (ft<sup>2</sup>); milligrams per liter (mg/L)



## 6 Complaint Investigation and Enforcement

### 6.1 Open Sewage Complaint Investigation Protocol

Revision: July 18, 2012

Pertinent information must be recorded from the complainant so an initial investigation can be conducted (i.e., name, address, and phone number of property owner and complainant and the nature of the complaint). Health district staff will investigate open sewage complaints stemming from subsurface sewage disposal systems. DEQ will investigate open sewage complaints regarding public wastewater treatment systems (e.g., collection, pumping, and treatment).

Gather the following equipment and prepare for investigation:

- Camera
- Dye (tablets or liquid)
- Notify laboratory of possibility for coliform density tests
- Sample bottles, whirl packs, sterilized equipment, and laboratory sample forms
- Ice chest and ice
- Disposable gloves

Go to the property, notify owners of the complaint, and conduct a complaint investigation. If the complaint is unfounded, notify the complainant of findings. If the open sewage complaint is valid:

1. Take pictures of any open sewage or evidence of wastewater.
2. Dye trace household plumbing if necessary to identify wastewater discharge location.
3. Collect samples of sewage.
4. Collect samples of surface water if directly discharged to water.
5. Place samples in ice chest and transport to laboratory.
6. Post primary and secondary contact recreational waters with open sewage notice until water sample results can be obtained.
7. Issue NOV directly to property owner or send notice via certified mail. Establish time frames for obtaining a replacement system permit (15 days), for system installation (30 days) and any corrective actions necessary to mitigate the public health hazard of the open sewage (items 8 and 9, immediate action).
8. Copy the county prosecutor with the NOV letter.
9. Require the septic tank(s) to be pumped on a daily basis, if necessary, with documentation sent to the health district office.
10. Require open sewage to be covered with soil. If property owner is unable to cover sewage with soil require the property owner to spread lime on top of open sewage.
11. Track property owner activity regarding compliance with NOV and any issued permit.
12. If the property owner fails to comply with the NOV file a complaint with the county prosecutor and ask the prosecutor to issue a citation against the property owner. Prepare case for court hearing.
13. Follow court's judgment, or hearing findings.

*This page intentionally left blank for correct double-sided printing.*

## 7 Rules and Codes

Revision: May 06, 2020

### 7.1 Administrative Rules

To access the official rule retained at the Idaho Department of Administration website, go to:  
<http://adminrules.idaho.gov/rules/current/58/index.html>.

- Individual/Subsurface Sewage Disposal Rules and Rules for Cleaning of Septic Tanks (IDAPA 58.01.03)

### 7.2 Idaho Code

To access the official rule retained at the Idaho Department of Administration website go to:  
<https://legislature.idaho.gov/statutesrules/idstat/Title39/> and  
<https://legislature.idaho.gov/statutesrules/idstat/Title50/>

- Idaho Code §39-1: Environmental Quality—Health
- Idaho Code §39-36: Water Quality
- Idaho Code §50-13: Plats and Vacations

*This page intentionally left blank for correct double-sided printing.*

## Appendix A. Glossary

Revision: March 9, 2017

<b>ABS</b>	Acrylonitrile-butadiene-styrene, a rigid plastic used in piping, building materials, and other products.
<b>Absorption</b>	Process that occurs when a substance diffuses into a liquid or solid.
<b>Adsorption</b>	Adhesion of a thin layer of molecules to the surfaces of solid bodies or liquids with which they are in contact.
<b>Aggregate</b>	Primary soil particles that cohere to each other more strongly than other surrounding particles or crushed rock or gravel screened to sizes for various uses as used in IDAPA 58.01.03.008.08. See media.
<b>Attached growth process</b>	Configuration where the microorganisms responsible for treatment colonize a fixed medium. See suspended-growth process.
<b>BOD</b>	Biological (or biochemical) oxygen demand. BOD determines the amount of substances in sewage that can be biologically broken down. Microorganisms can break down these substances, as long as oxygen is present. BOD is a chemical procedure that measures how fast biological organisms in a sample of water use up oxygen.
<b>CAP</b>	A commercially manufactured wastewater treatment system product has been found to have malfunctioning system rates of 10% or more, DEQ will disapprove the manufacturer's product and provide the manufacturer the opportunity to enter into a corrective action plan (CAP) for product reinstatement. The CAP should establish the time frame to return the noncomplying product to proper operation. The product disapproval will remain in effect until the malfunctioning and failing system rate for the manufacturer's product is below 10%.
<b>CBOD<sub>5</sub></b>	Refers to the 5-day test for carbonaceous biochemical oxygen demand, which measures how much oxygen wastewater uses. CBOD <sub>5</sub> measures the rate of oxygen use by living organisms (bacteria) decomposing the organic portion of a waste in a sample of water. CBOD <sub>5</sub> is measured in milligrams per liter.
<b>Component</b>	Subsection of a treatment train or system.

<b>C<sub>u</sub></b>	Coefficient of uniformity. Ratio of diameters from a soil sieve analysis. Ratio divides the diameter corresponding to the 60% finer value by that diameter corresponding to the 10% finer value.
<b>DEQ</b>	Idaho Department of Environmental Quality is the state agency responsible for enforcing the “Individual/Subsurface Sewage Disposal Rules” (IDAPA 58.01.03).
<b>Distal pressure</b>	Design and operational parameter measured at the furthest point from the dosing device in a pressurized system; typically expressed in vertical feet of head.
<b>Effluent</b>	Outflowing water from a wastewater process. Processes range from clarification in a septic tank to filtrate from a microfiltration membrane
<b>ET/ETI</b>	Evapotranspiration/evapotranspiration and infiltrative
<b>ETPS</b>	Extended treatment package system
<b>HDPE</b>	High-density polyethylene
<b>HRT</b>	Hydraulic residence time
<b>Hydraulic conductivity</b>	Coefficient of permeability—a property of the soil media describing how easily water flows through the soil matrix.
<b>IDAPA</b>	Numbering designation for all administrative rules in Idaho promulgated in accordance with the Idaho Administrative Procedures act.
<b>Infiltration</b>	Process by which water enters the soil.
<b>Media</b>	Solid material that can be described by shape, dimensions, surface area, void space, and application. See aggregate.
<b>Media, Distribution</b>	Material used to provide void space (usually in a dispersal component) through which effluent flows and is stored before infiltration (e.g., washed stone, aggregate, polystyrene blocks, and chambers).
<b>NOV</b>	Notice of violation
<b>NPDES</b>	National Pollutant Discharge Elimination System
<b>O&amp;M</b>	Operations and maintenance
<b>Percolation</b>	Movement and filtering of water through the soil
<b>Permeability</b>	Measure of a porous media to transmit water.

<b>PF</b>	Peaking factor
<b>PVC</b>	Polyvinyl chloride
<b>SI</b>	International System of Units (from the French le Système International d 'Unités)
<b>Soil texture</b>	Soil property that describes the relative proportions of different grain sizes of mineral particles. The fine fraction, composed of sand, silt, and clay, are used exclusively.
<b>Suspended growth process</b>	Configuration where the microorganisms responsible for treatment are maintained in suspension within a liquid.
<b>Total Kjeldahl nitrogen</b>	Total mass of a solution's organic and ammonia nitrogen present.
<b>Total nitrogen</b>	Total mass of a solution's organic nitrogen, ammonia, nitrite, and nitrate.
<b>Total suspended solids</b>	Portion of the total solids on a filter with a specified pore size, measured after being dried at a specified temperature (105 °C).

*This page intentionally left blank for correct double-sided printing.*



## Appendix B. Triangle and Flowchart for Soil Texture Determination

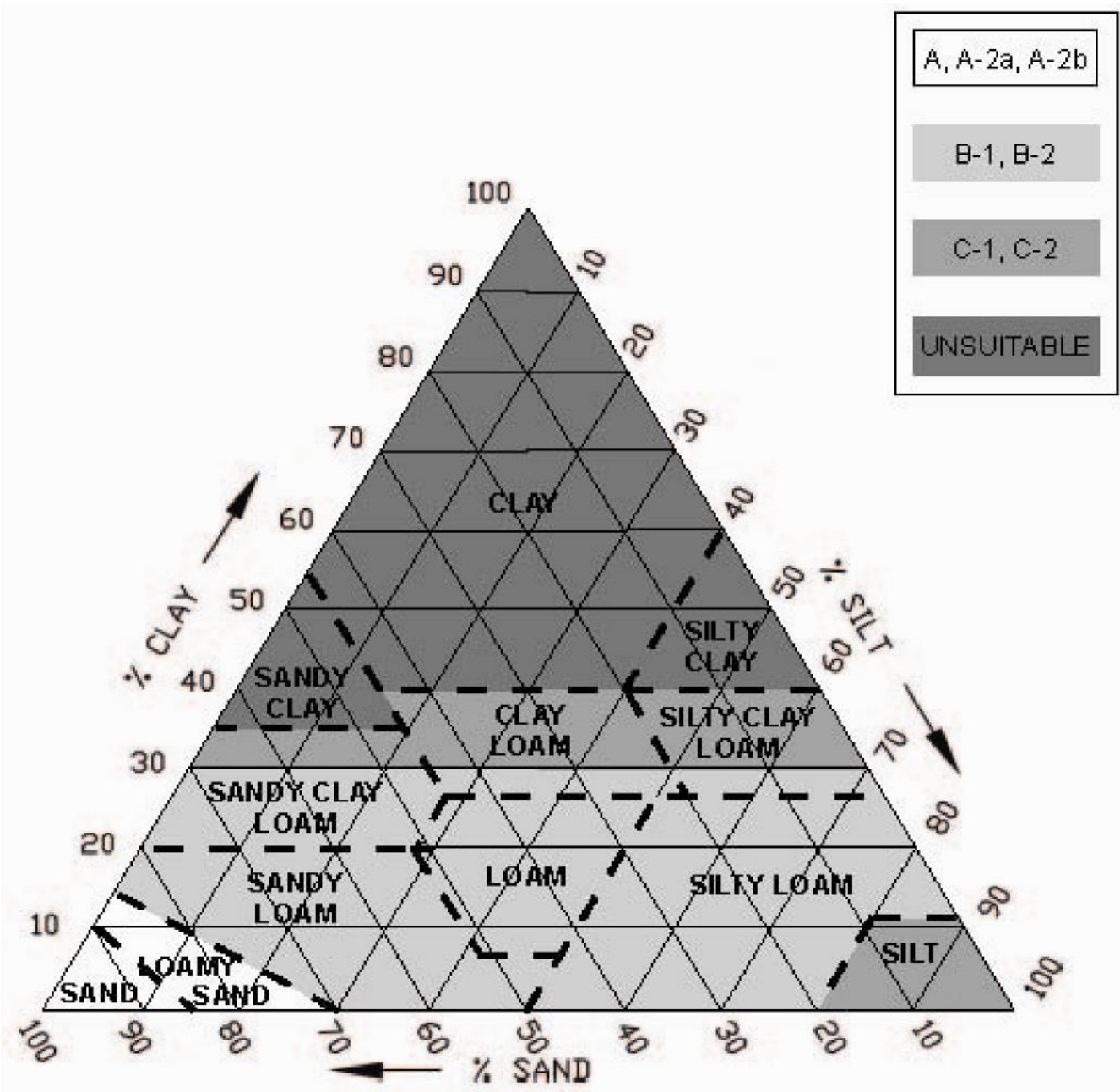

Soil texture determination triangle.

### TGM-Soil Texture Flowchart

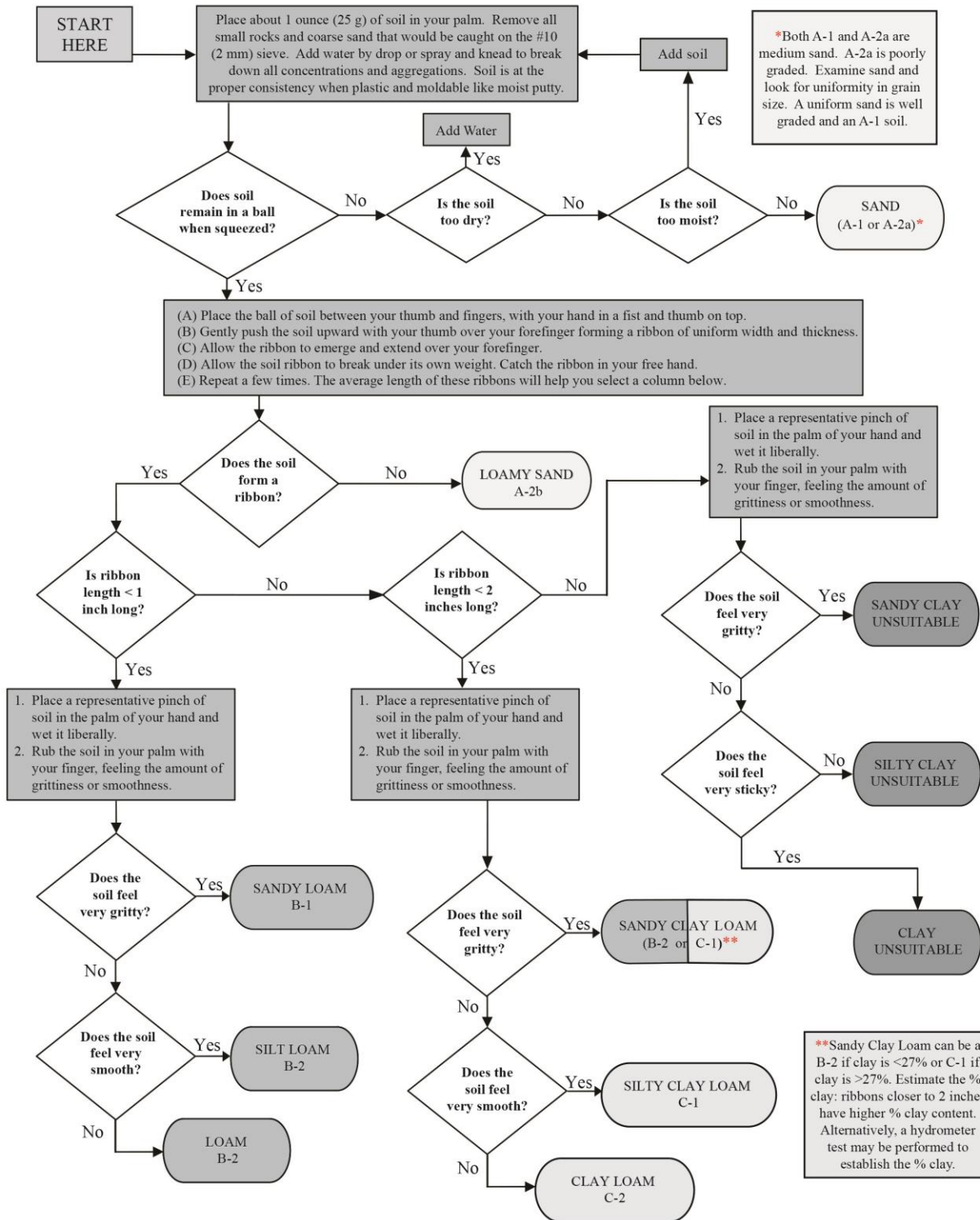

Soil texture determination flowchart.